

Step-Down, 1A Dimmable LED Driver**Features**

- 6~40V wide input voltage range
- Maximum 1A constant output current
- PWM/ DC input for dimming control
- Hysteretic PFM operation eliminates external compensation design
- Integrated power switch with 0.3ohm low $R_{ds(on)}$
- Full protections: UVLO/ Start-Up/ OCP/ Thermal/ LED Open/Short-Circuit
- Only 5 external components required
- Package MSL Level: 3

Product Description

MBI6656 is a step-down constant-current high-brightness LED driver to provide a cost-effective design solution for interior/exterior illumination applications. It is designed to deliver constant current to light up high power LED with only 5 external components. With hysteretic PFM control scheme, MBI6656 eliminates external compensation design and makes the design simple.

The output current of MBI6656 can be programmed by an external resistor and dimmed via pulse width modulation (PWM) or DC voltage through DIM pin to achieve higher efficiency linear current modulation.

MBI6656 features completed protection design to handle faulty situations. The start-up function limits the inrush current while the power is switched on. Under voltage lock out (UVLO), over temperature protection (OTP), and over current protection (OCP) guard the system to be robust and keep the driver away from being damaged which results from LED open-circuited, short-circuited and other abnormal events. Besides SOT-236 small package, MBI6656 provides thermal-enhanced SOT-89, SOP-8 and TO-252 packages as well to handle power dissipation more efficiently.

Applications

- Signage and Decorative LED Lighting
- High Power LED Lighting
- Constant Current Source

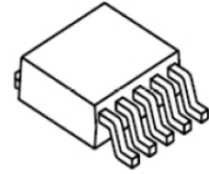
Surface Mount Device

GSD: TO-252-5L

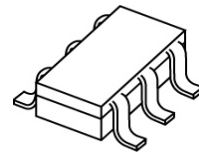
Small Outline Transistor

GST: SOT-23-6L

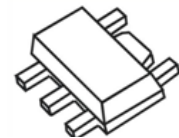

GSB: SOT-89-5L

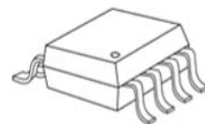
Small Outline Package

GD: SOP8L-150-1.27

Typical Application Circuit

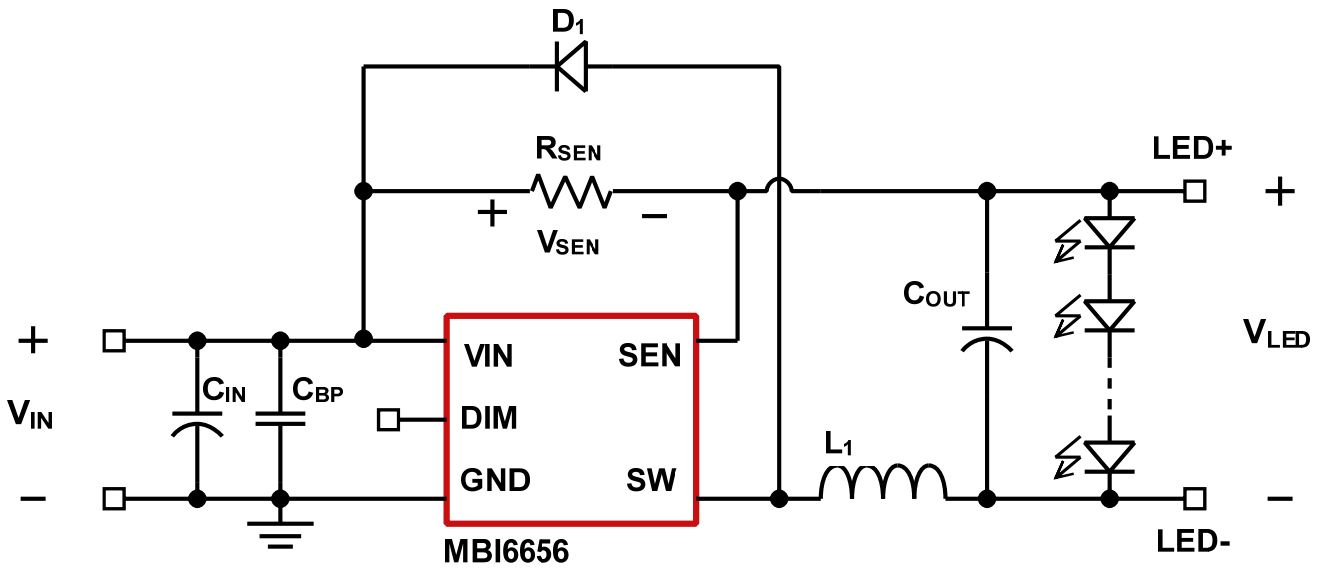

Fig. 1 Application circuit of MBI6656

Functional Diagram

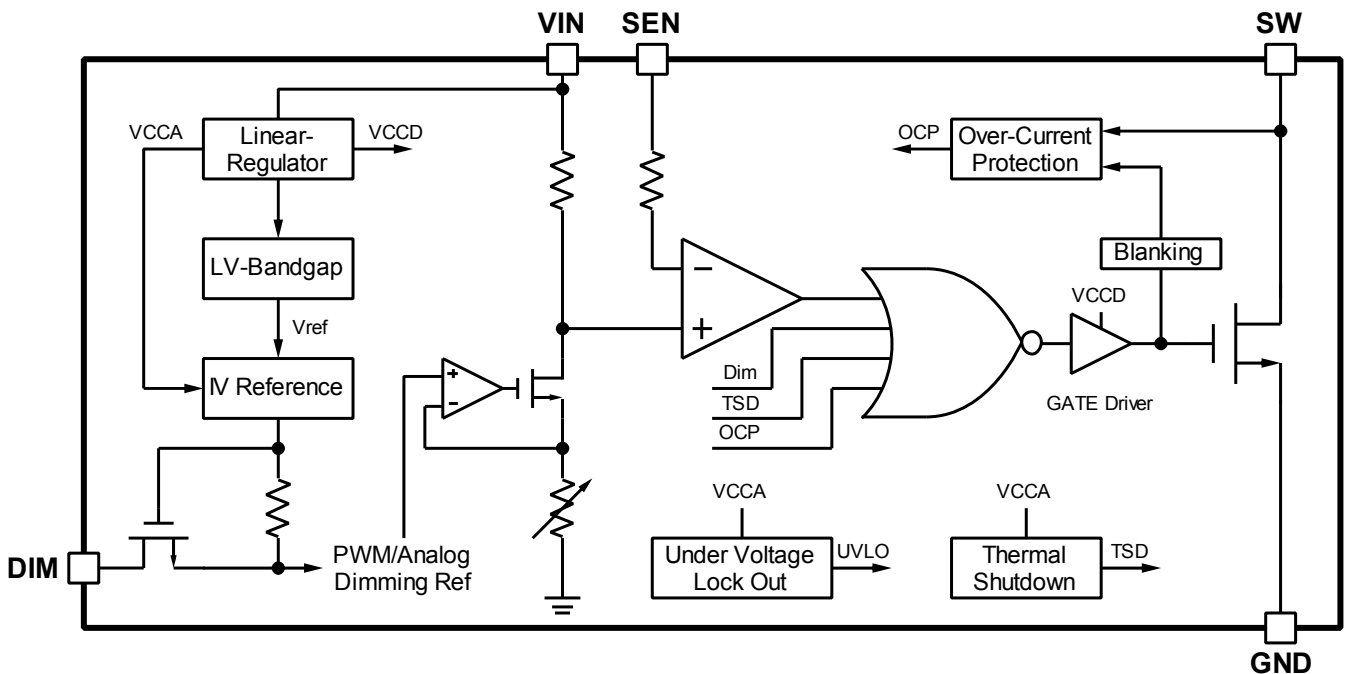
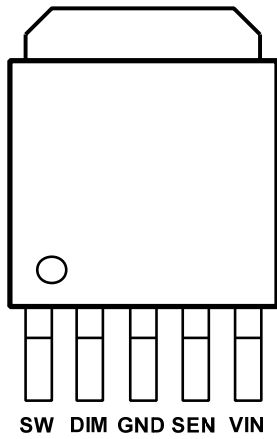
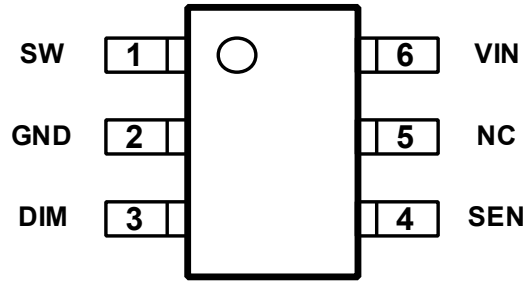

Fig. 2 Function block diagram of MBI6656

Pin Configuration



MBI6656GSD (Top View)



MBI6656GST (Top View)

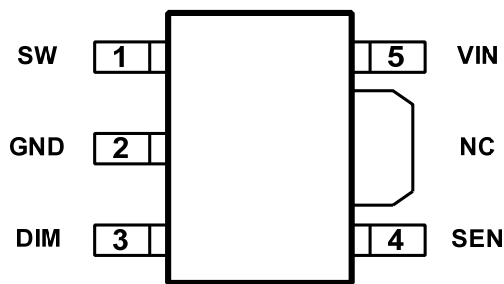

MBI6656GSB (Top View)

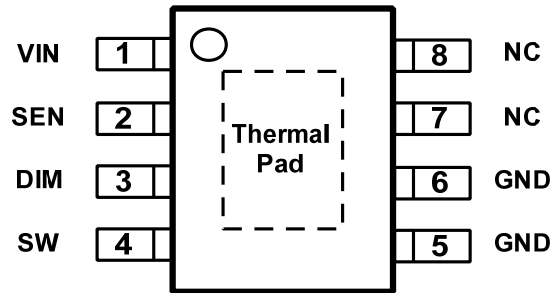

MBI6656GD (Top View)

Pin Description

Pin Name	Function
GND	Ground terminal for control logic and current sink
SW	Switch output terminal
DIM	Digital/Analog dimming control terminal. PWM or DC voltage signal is applied into the terminal for brightness control.
SEN	Output current sense terminal
VIN	Supply voltage terminal
Thermal Pad	Power dissipation terminal connected to GND*

*To improve the noise immunity, the thermal pad is suggested to connect to GND on PCB. In addition, when a heat-conducting copper foil on PCB is soldered with thermal pad, the desired thermal conductivity will be improved.

Maximum Ratings

Operation above the maximum ratings may cause device failure. Operation at the extended periods of the maximum ratings may reduce the device reliability.

Characteristic		Symbol	Rating	Unit
Supply Voltage		V_{IN}	0~45	V
Sustaining Voltage at DIM pin		V_{DIM}	-0.3~45	V
Sustaining Voltage at SW pin		V_{SW}	-0.3~45	V
Sustaining Voltage at SEN pin		V_{SEN}	-0.3~45	V
Power Dissipation (On 4-Layer PCB, $T_a=25^{\circ}C$)	GSD Type	P_D	3.80	W
Thermal Resistance (By simulation, on 4-Layer PCB)*		$R_{th(j-a)}$	32.9	$^{\circ}C/W$
Power Dissipation (On 4-Layer PCB, $T_a=25^{\circ}C$)	GST Type	P_D	0.51	W
Thermal Resistance (By simulation, on 4-Layer PCB)*		$R_{th(j-a)}$	244.0	$^{\circ}C/W$
Power Dissipation (On 4-Layer PCB, $T_a=25^{\circ}C$)	GSB Type	P_D	1.77	W
Empirical Thermal Resistance (On PCB, $T_a=25^{\circ}C$)**		$R_{th(j-a)}$	70.8	$^{\circ}C/W$
Power Dissipation (On 4-Layer PCB, $T_a=25^{\circ}C$)	GD Type	P_D	1.49	W
Empirical Thermal Resistance (On PCB, $T_a=25^{\circ}C$)**		$R_{th(j-a)}$	84.0	$^{\circ}C/W$
Junction Temperature		$T_{j,max}$	150***	$^{\circ}C$
Operating Ambient Temperature		T_{opr}	-40~+85	$^{\circ}C$
Storage Temperature		T_{stg}	-55~+150	$^{\circ}C$
ESD Rating	Human Body Mode (MIL-STD-883G Method 3015.8)	HBM	Class 3A (5KV)	-
	Machine Mode (ANSI/ ESD S5.2-2009)	MM	Class M4 (400V)	-

*The PCB size is 76.2mm*114.3mm in simulation. Please refer to JEDEC JESD51-7 thermal measurement standard.

**The PCB area is 4 times larger than that of IC's and without extra heat sink. Please refer to JEDEC JES51-3 thermal measurement standard.

***Operation at the maximum rating for extended periods may reduce the device reliability; therefore, the suggested junction temperature of the device is under 125 $^{\circ}C$.

Note: The performance of thermal dissipation is strongly related to the size of thermal pad, thickness and layer numbers of the PCB. The empirical thermal resistance may be different from simulative value. Users should plan for expected thermal dissipation performance by selecting package and arranging layout of the PCB to maximize the capability.

Electrical Characteristics
 $V_{IN}=12V$, $V_{OUT}=3.6V$, $L_1=68\mu H$, $C_{IN}=C_{OUT}=10\mu F$, $T_A=25^\circ C$; unless otherwise specified.

Characteristics		Symbol	Condition	Min.	Typ.	Max.	Unit
INPUT AND OUTPUT							
Supply Voltage		V_{IN}	-	6	-	40	V
Supply Current		I_{IN}	$V_{IN}=6V\sim 40V$	-	-	2	mA
Start-Up Voltage		V_{SU}	-	-	5.4	-	V
Under Voltage Lock Out Voltage		V_{UVLO}	-	-	5.3	-	V
HYSTERESIS CONTROL							
Mean Sense Voltage		V_{SENSE}	-	95	100	105	mV
Sense Voltage threshold hysteresis		$V_{SENSE,HYS}$	-	-	15	-	%
Internal Propagation Delay Time		T_{PD}	-	100	200	320	ns
MOS SWITCH							
Switch ON Resistance		$R_{ds(on)}$	$V_{IN}=12V$	-	0.3	0.4	Ω
Minimum Switch ON Time*		$T_{ON,min}$	-	-	300	-	ns
Minimum Switch OFF Time*		$T_{OFF,min}$	-	-	300	-	ns
Recommended Duty Cycle Range of SW*		D_{sw}	-	20	-	80	%
Maximum Operating frequency		$Freq_{Max}$	-	40	-	1000	kHz
THERMAL OVERLOAD							
Thermal Shutdown Threshold*		T_{SD}	-	145	165	175	$^\circ C$
Thermal Shutdown Hysteresis*		T_{SD-HYS}	-	20	30	40	$^\circ C$
PWM DIMMING							
Input voltage of PWMD	"H" level	V_{IH}	-	2.5	-	40	V
	"L" level	V_{IL}	-	-	-	0.3	V
Duty Cycle Range of PWM Signal Applied to DIM pin		$Duty_{PWM}$	PWM Frequency: 1kHz	0	-	100	%
ANALOG DIMMING							
Analog Dimming Input Clamp Voltage		$V_{DIM.CLAMP}$		-	2.5	-	V
Analog Dimming Input Voltage turn off SW		$V_{DIM.SWOFF}$		-	0.3	-	V
OVER CURRENT PROTECTION							
Over Current Threshold*		OCP	-	-	2.5	-	A

*Parameters are not tested at production. Parameters are guaranteed by design.

Typical Performance Characteristic

1. Efficiency vs. Input Voltage at Various LED Cascaded Numbers

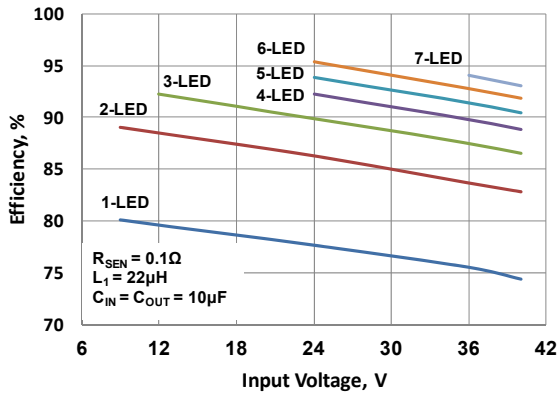

(a) $L_1 = 22\mu\text{H}$

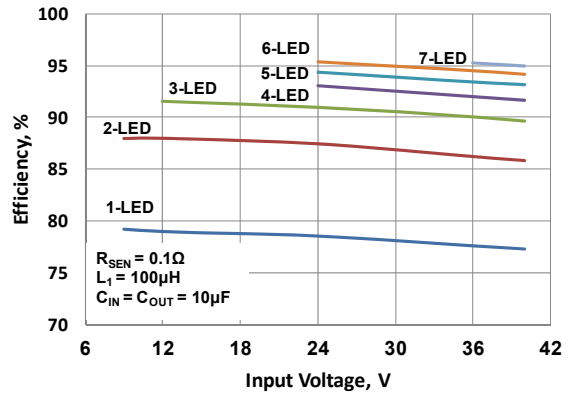

(b) $L_1 = 100\mu\text{H}$

Fig. 3 Efficiency vs. input voltage at $I_{OUT} = 1\text{A}$

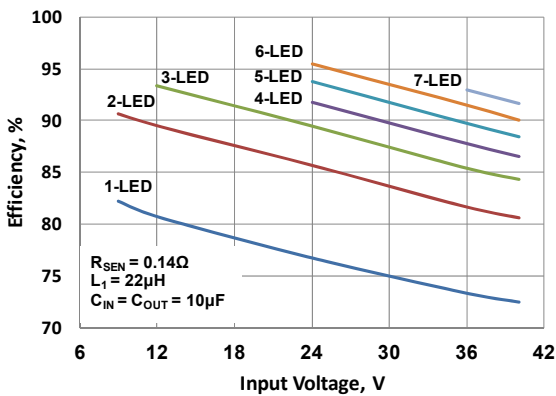

(a) $L_1 = 22\mu\text{H}$

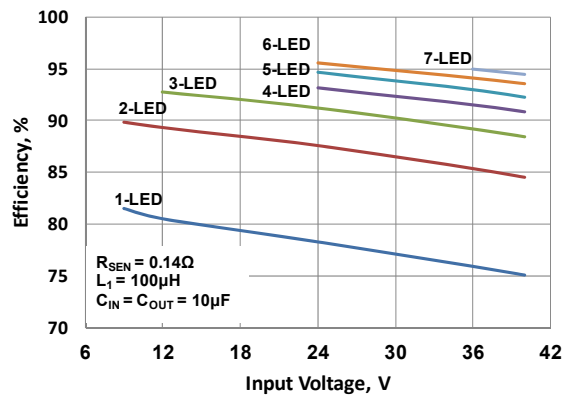

(b) $L_1 = 100\mu\text{H}$

Fig. 4 Efficiency vs. input voltage at $I_{OUT} = 700\text{mA}$

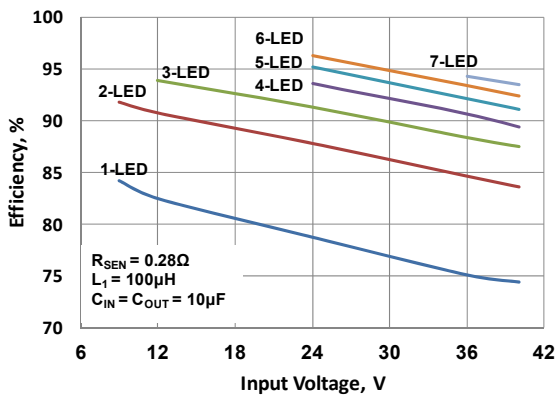

(a) $L_1 = 100\mu\text{H}$

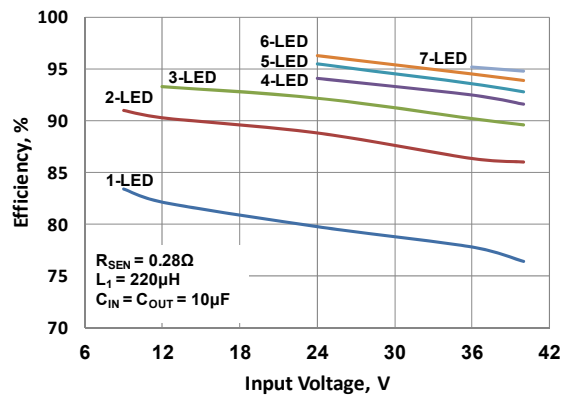

(b) $L_1 = 220\mu\text{H}$

Fig. 5 Efficiency vs. input voltage at $I_{OUT} = 350\text{mA}$

2. Output Current vs. Input Voltage at Various LED Cascaded Numbers

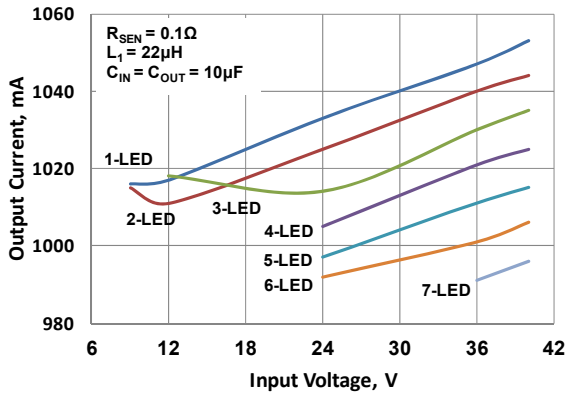

(a) $L_1 = 22\mu\text{H}$

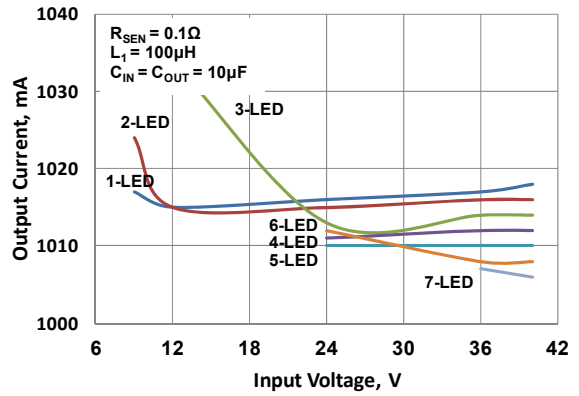

(b) $L_1 = 100\mu\text{H}$

Fig. 6 Output current vs. input voltage at $I_{OUT} = 1\text{A}$

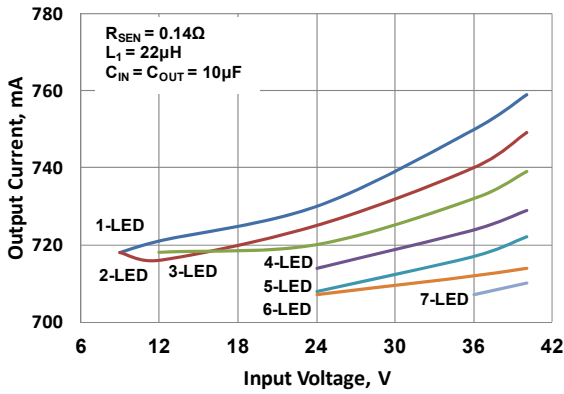

(a) $L_1 = 22\mu\text{H}$

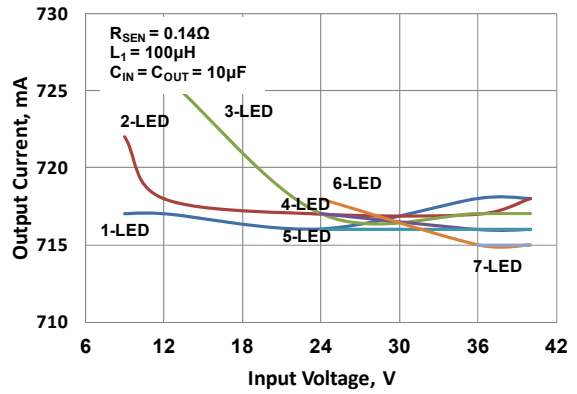

(b) $L_1 = 100\mu\text{H}$

Fig. 7 Output current vs. input voltage at $I_{OUT} = 700\text{mA}$

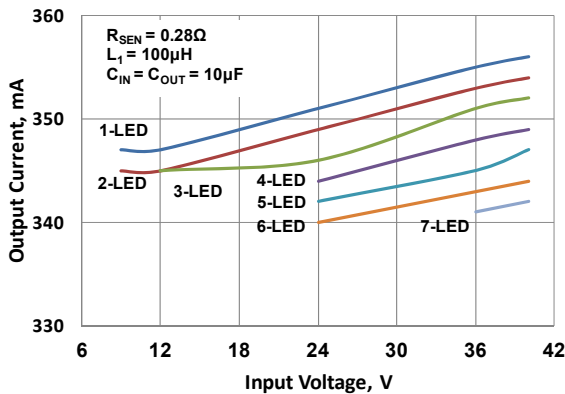

(a) $L_1 = 100\mu\text{H}$

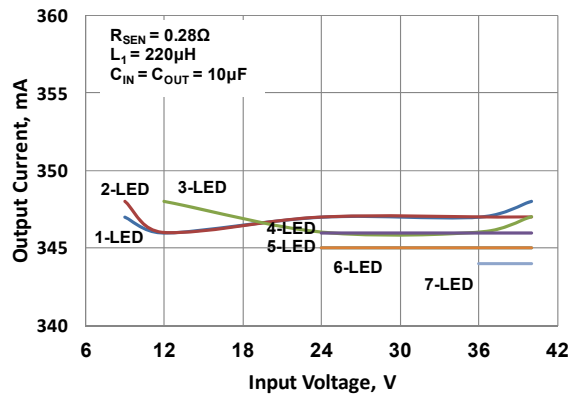

(b) $L_1 = 220\mu\text{H}$

Fig. 8 Output current vs. input voltage at $I_{OUT} = 350\text{mA}$

3. Switching Frequency vs. LED Cascaded Number at Various Inductor

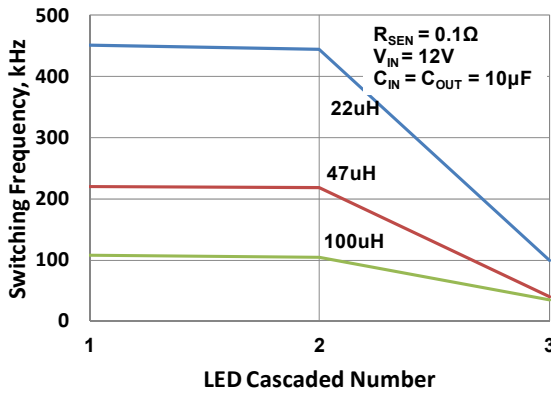

(a) $V_{IN} = 12V$

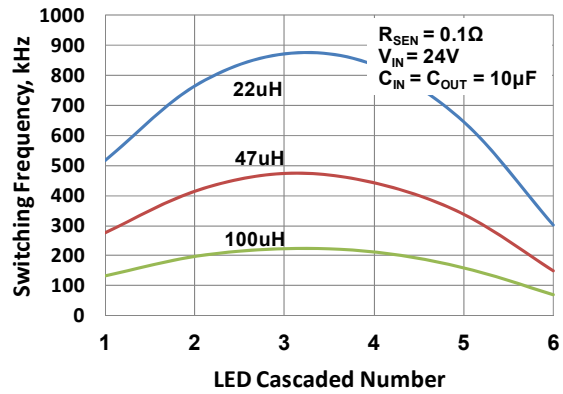

(b) $V_{IN} = 24V$

Fig. 9 Output current vs. LED cascaded number at $I_{OUT} = 1A$

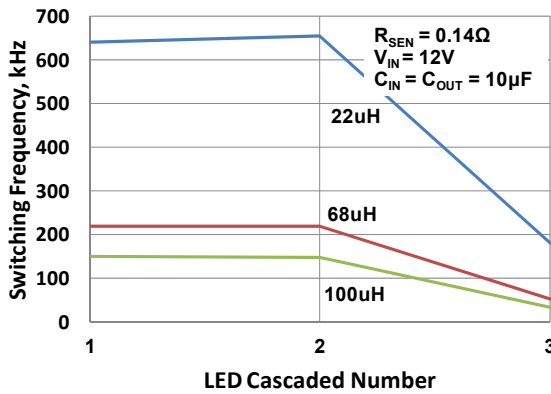

(a) $V_{IN} = 12V$

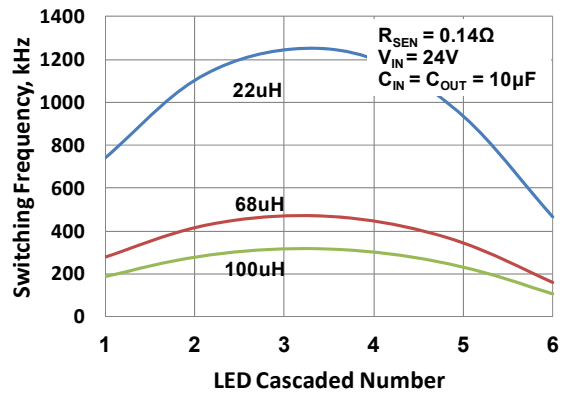

(b) $V_{IN} = 24V$

Fig. 10 Output current vs. LED cascaded number at $I_{OUT} = 700mA$

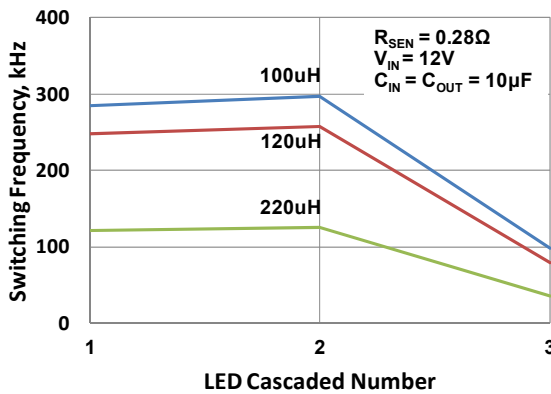

(a) $V_{IN} = 12V$

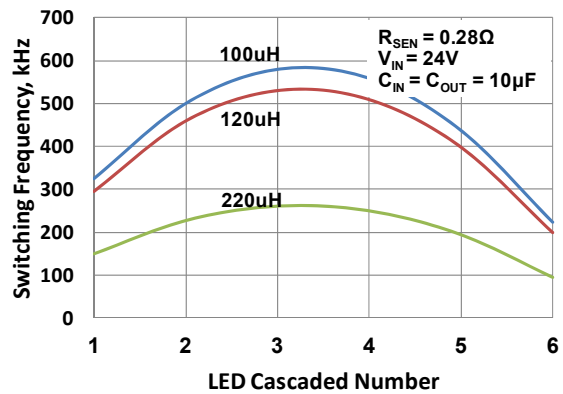

(b) $V_{IN} = 24V$

Fig. 11 Output current vs. LED cascaded number at $I_{OUT} = 350mA$

4. Output Current vs. Ambient Temperature at $V_{IN} = 12V$

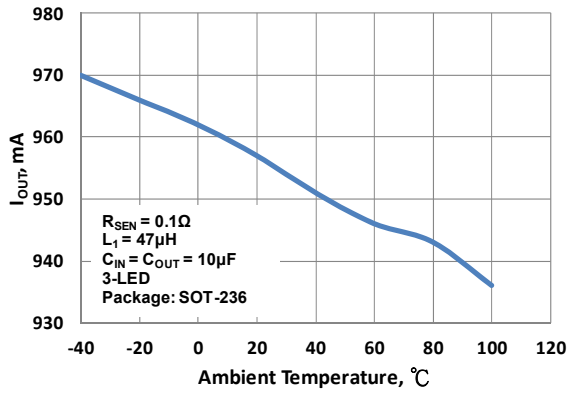

(a) $I_{OUT} = 1A$

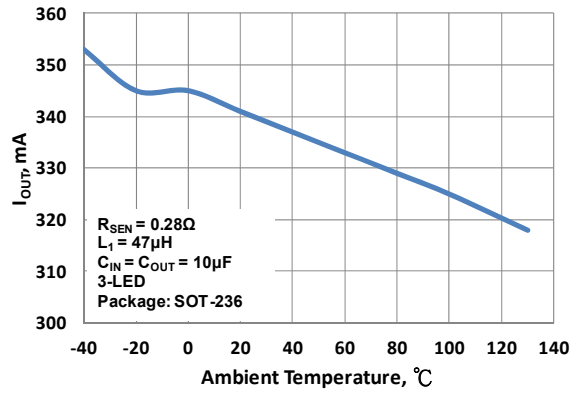

(b) $I_{OUT} = 350mA$

Fig. 12 Output Current vs. Ambient Temperature at $V_{IN} = 12V$

5. $R_{ds(on)}$ vs. Ambient Temperature at $V_{IN} = 12V$

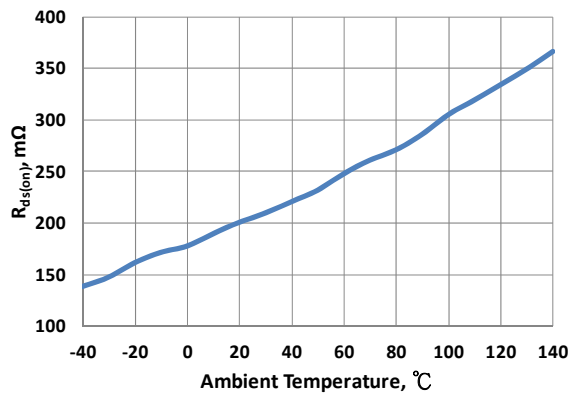

Fig. 13 $R_{ds(on)}$ vs. Temperature at $V_{IN} = 12V$

Application Information

MBI6656 is a simple and high efficient buck converter with capability to drive up to 1A of loading. The device adopts hysteretic PFM control scheme to regulate loading and input voltage variations. The hysteretic PFM control requires no loop compensation bringing very fast load transient response and simplicity of the design.

The device is well suited for applications requiring a wide input voltage range. The high-side current sensing and an integrated current-setting circuitry minimize the number of external components while delivering an average output current with $\pm 5\%$ accuracy. Featured by PWM dimming and analog dimming capability, MBI6656 offers flexible ways to meet LED dimming related applications.

Setting Average Output Current

The average output current (I_{OUT}) is set by an external resistor, R_{SEN} . The relationship between I_{OUT} and R_{SEN} is as below:

$$R_{SEN} = (V_{SEN} / I_{OUT}) = (0.1V / I_{OUT}); V_{SEN} = 0.1V;$$

$$I_{OUT} = (V_{SEN} / R_{SEN}) = (0.1V / R_{SEN})$$

where R_{SEN} is the resistance of the external resistor connecting to SEN pin, and V_{SEN} is the voltage of external resistor. The magnitude of current (as a function of R_{SEN}) is around 1000mA at 0.1 Ω .

Dimming Functions

Dimming is achieved by applying either a PWM signal or a DC voltage at the DIM pin. For analog dimming application, the LED current increases linearly with the rising V_{DIM} , and the dimming range of V_{DIM} is from 0.3V to 2.5V. For PWM dimming application, the LED current can be adjusted digitally, by applying a PWM logic signal to the DIM pin to turn the device on and off, as shown on Fig. 14.

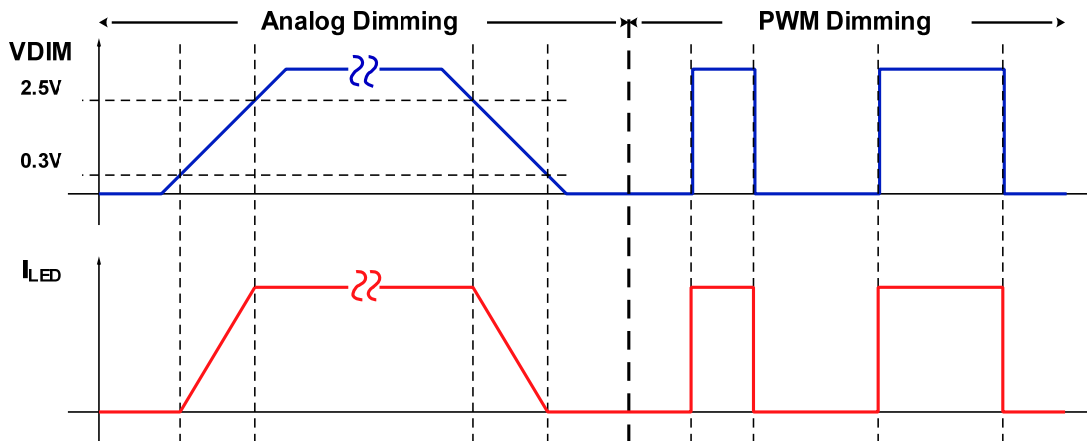

Fig. 14 Dimming waveform diagram

A. PWM dimming

The dimming of LEDs can be performed by applying PWM signals of DIM pin. A logic low (below 0.3V) at DIM disables the internal MOSFET and shuts off the current flow to the LED array. An internal pull-up circuit ensures that the MBI6656 is ON when DIM pin is unconnected. Therefore, the need for an external pull-up resistor will be eliminated. The following Fig. 13 shows good linearity in dimming control.

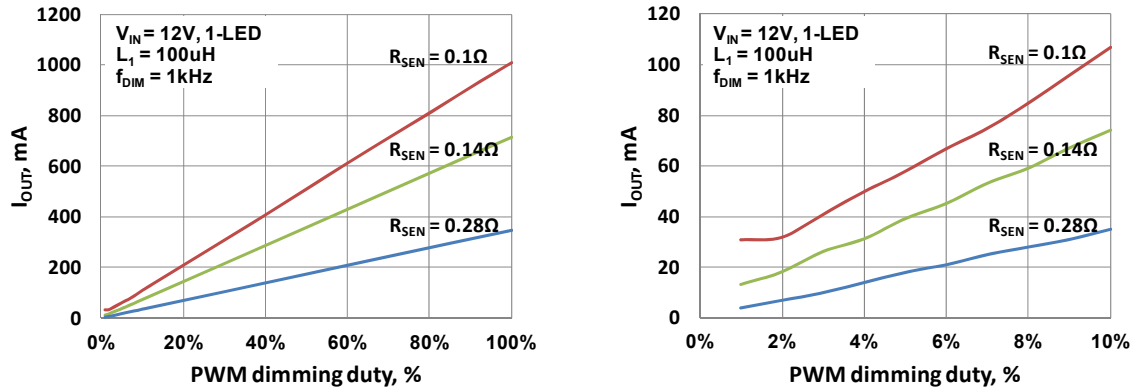

Fig. 15 PWM dimming curve

B. Analog dimming

Users can also apply DC voltage directly to DIM for modulating LED current. The result is shown in the following figures.

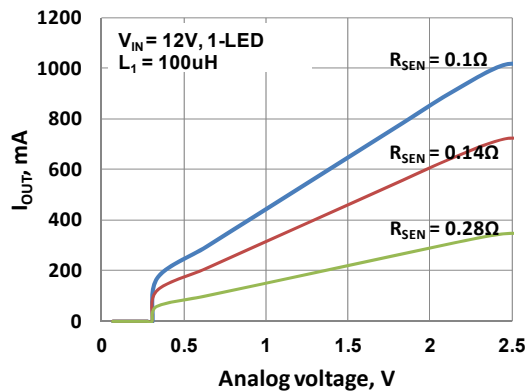

Fig. 16 Analog dimming curve

Component Selection

A. Inductor Selection

The inductance is determined by two factors: the switching frequency and the inductor ripple current. The calculation of the inductance, L_1 , can be described as

$$L_1 = \frac{(V_{IN} - V_{LED}) \cdot \frac{V_{LED}}{V_{IN}}}{0.3 \times f_s \times I_{LED}}$$

When selecting an inductor, not only the inductance but also the saturation current that should be considered as the factors to affect the performance of module. In general, it is recommended to choose an inductor with 1.5 times of LED current as the saturation current. Also, the larger inductance gains the better line/load regulation. However, the inductance and saturation current become a trade-off at the same inductor size. An inductor with shield is recommended to reduce the EMI interference. However, this is another trade-off with heat dissipation.

B. Schottky Diode Selection

The MBI6656 needs a flywheel diode, D_1 , to carry the inductor current when the MOSFET is off. The recommended flywheel diode is schottky diode with low forward voltage for better efficiency. Two factors determine the selection of

schottky diode. One is the maximum reverse voltage. The recommended rated voltage of the reverse voltage is at least 1.5 times of input voltage. The other is the maximum forward current, which works when the MOSFET is off. And the recommended forward current is 1.5 times of output current. Users should carefully choose an appropriate schottky diode which can perform low leakage current at high temperature.

C. Input Capacitor Selection

The input capacitor, C_{IN} , can supply pulses of current for the MBI6656 when the MOSFET is ON. And C_{IN} is charged by input voltage when the MOSFET is OFF. As the input voltage is lower than the tolerable input voltage, the internal MOSFET of the MBI6656 remains constantly ON, and the LED current is limited to 1.15 times of normal current. The recommended value of input capacitor is 10uF to stabilize the lighting system. The rated voltage of the input capacitor should be at least 1.5 times of the input voltage.

For system stability, it is recommended to place the C_{IN} to the VIN pin of MBI6656 as close as possible. However, the PCB size might limit this requirement. Therefore, to avoid the noise interference, a bypass capacitor, whose capacitance range is from 0.1uF to 1uF and the material is ceramic, parallels with the VIN and GND pins of MBI6656 is recommended. The rated voltage of the bypass capacitor should be at least 1.5times of the input voltage.

The rated voltage and capacitance are not the only concerns when selecting capacitors, but also the maximum ripple current. If the actual ripple current is larger than the specified maximum ripple current, the capacitor and the IC might be damaged. In general, the ripple current is related to the inductor ripple current. The specification of maximum ripple current of capacitor should be larger than 1.3 times of the inductor ripple current.

D. Output Capacitor Selection (Optional)

A capacitor paralleled with cascaded LED can reduce the LED ripple current and allow smaller inductance.

Package Power Dissipation (P_D)

The maximum power dissipation, $P_n(max)=(T_i-T_a)/R_{th(i-a)}$, decreases as the ambient temperature increases.

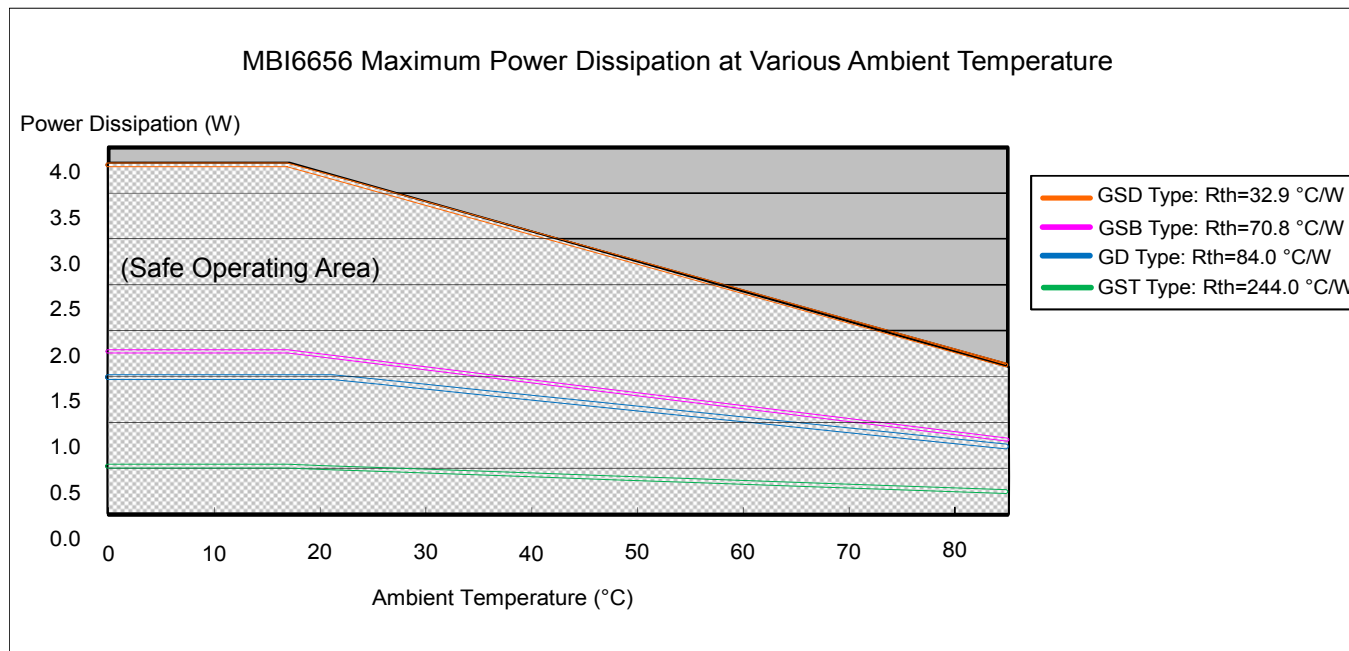

Soldering Process of "Pb-free" Package Plating*

Macroblock has defined "Pb-Free & Green" to mean semiconductor products that are compatible with the current RoHS requirements and selected 100% pure tin (Sn) to provide forward and backward compatibility with both the current industry-standard SnPb-based soldering processes and higher-temperature Pb-free processes. Pure tin is widely accepted by customers and suppliers of electronic devices in Europe, Asia and the US as the lead-free surface finish of choice to replace tin-lead. Also, it adopts tin/lead (SnPb) solder paste, and please refer to the JEDEC J-STD-020C for the temperature of solder bath. However, in the whole Pb-free soldering processes and materials, 100% pure tin (Sn) will all require from 245 °C to 260 °C for proper soldering on boards, referring to JEDEC J-STD-020C as shown below.

For managing MSL3 Package, it should refer to JEDEC J-STD-020C about floor life management & refer to JEDEC J-STD-033C about re-bake condition while IC's floor life exceeds MSL3 limitation.

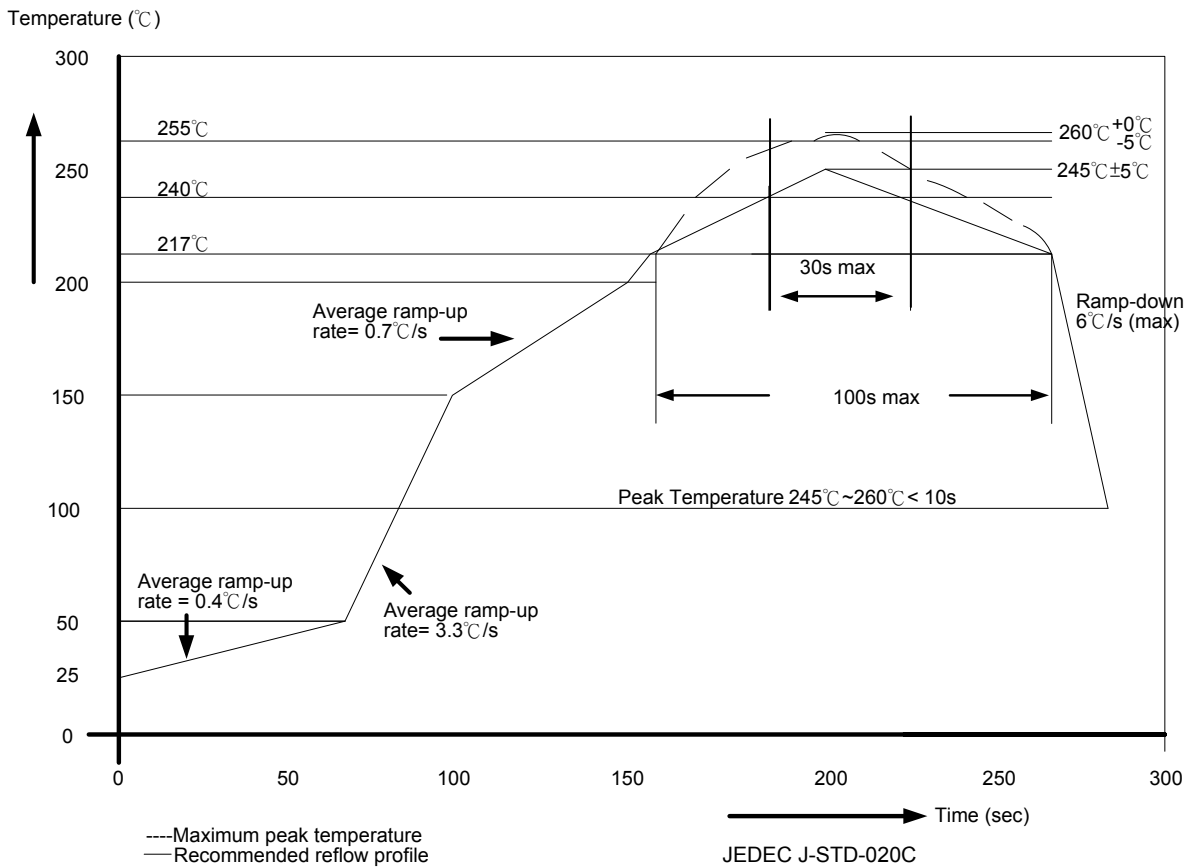

Package Thickness	Volume mm ³ <350	Volume mm ³ 350-2000	Volume mm ³ ≥2000
<1.6mm	260 + 0 °C	260 + 0 °C	260 + 0 °C
1.6mm – 2.5mm	260 + 0 °C	250 + 0 °C	245 + 0 °C
≥ 2.5mm	250 + 0 °C	245 + 0 °C	245 + 0 °C

* For details, please refer to Macroblock's "Policy on Pb-free & Green Package".

Outline Drawing

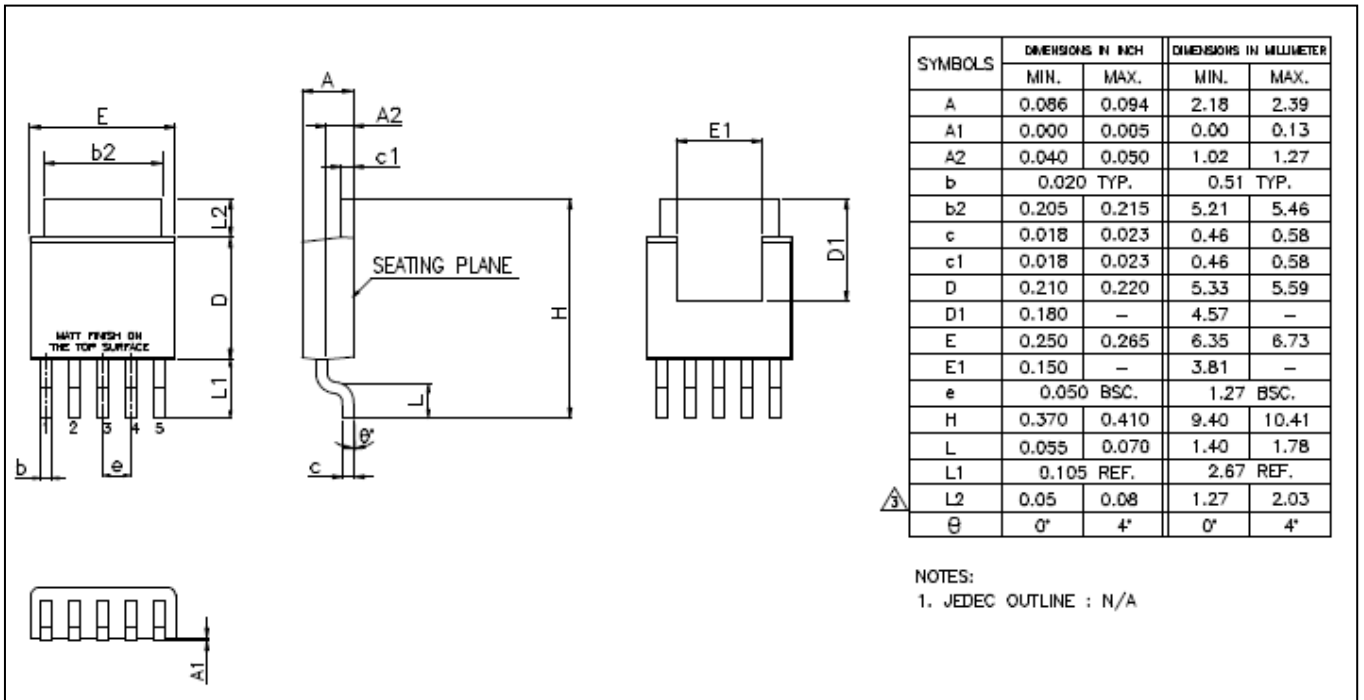

MBI6656 GSD Outline Drawing

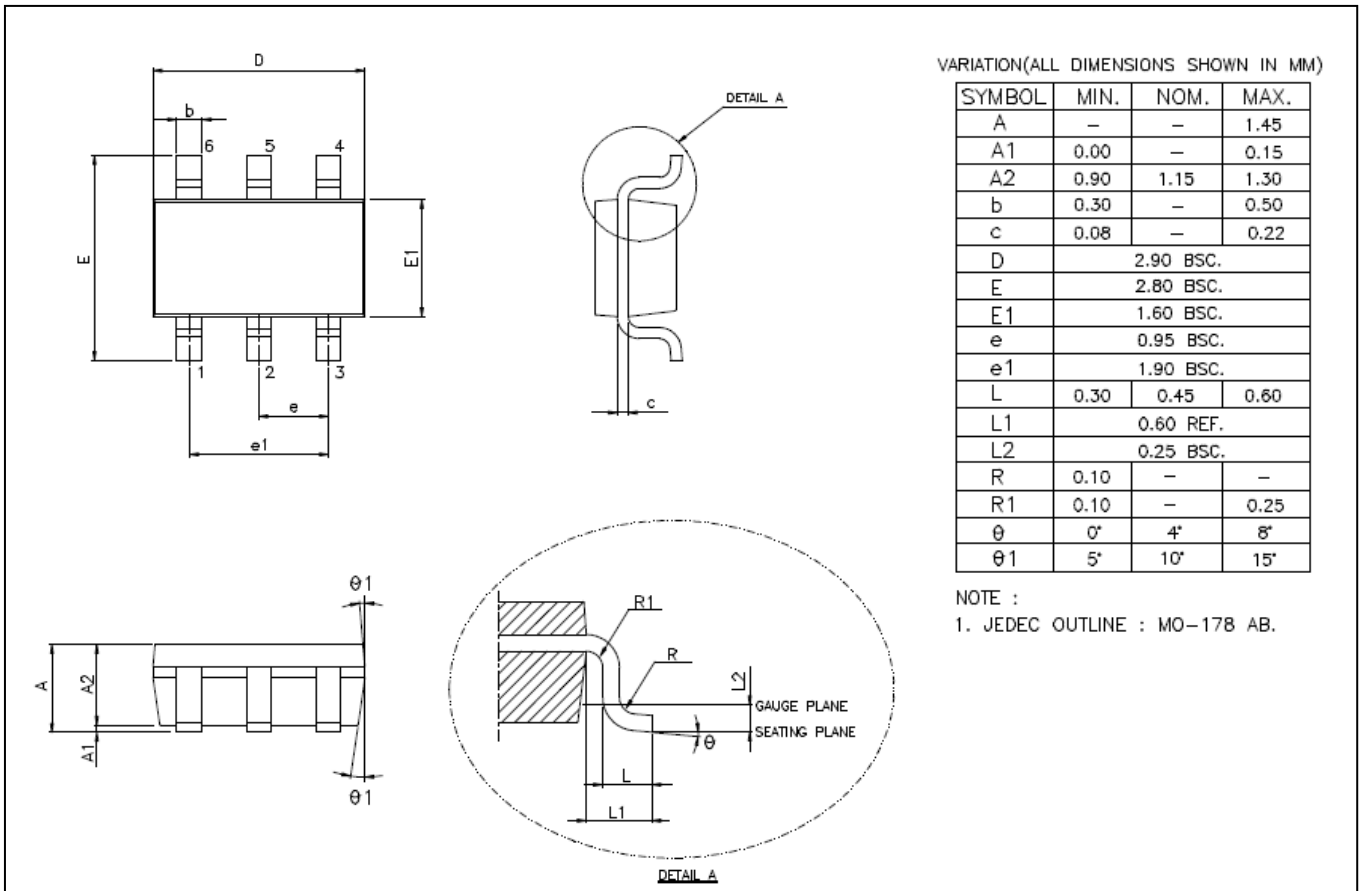

MBI6656 GST Outline Drawing

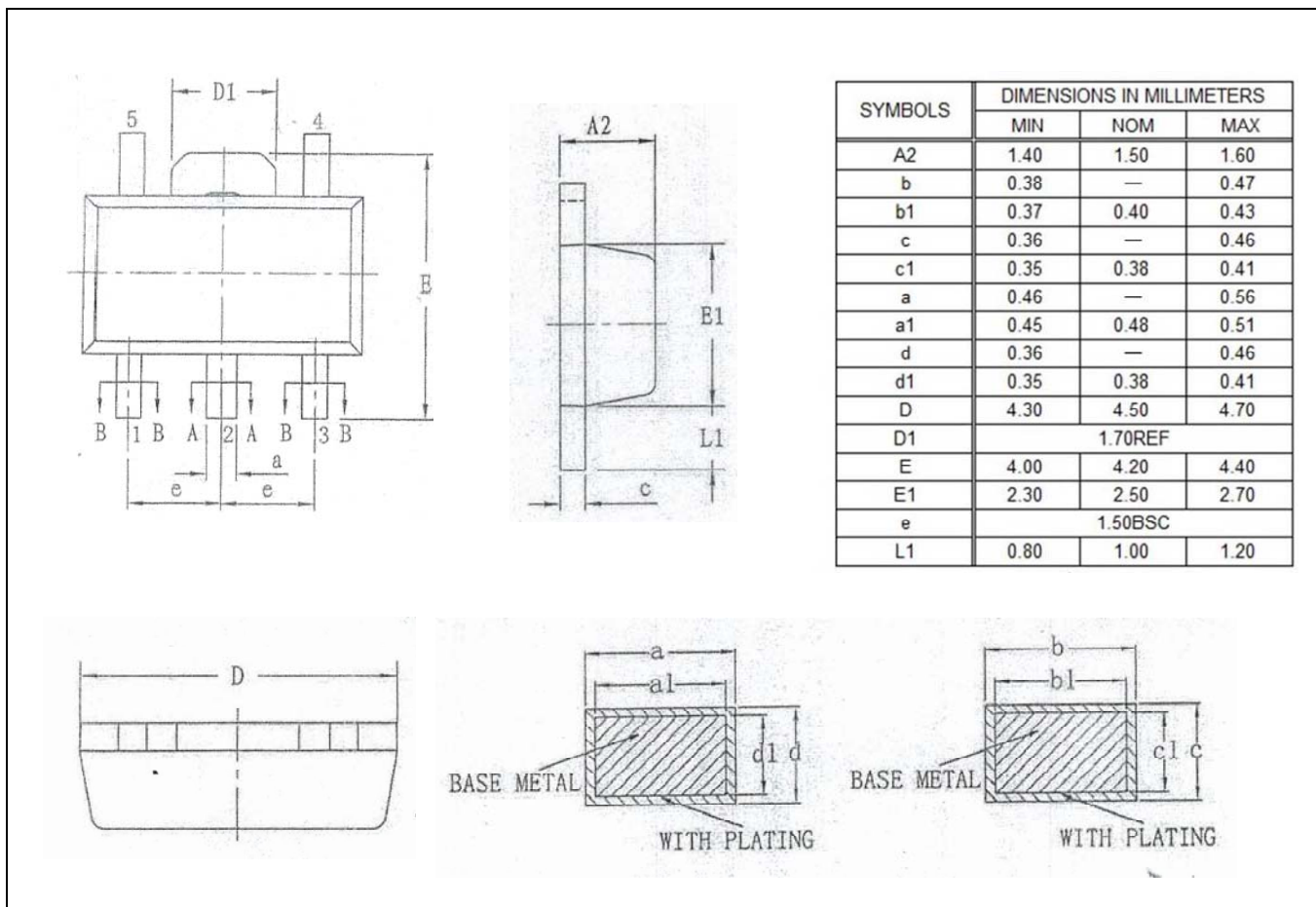

MBI6656 GSB Outline Drawing

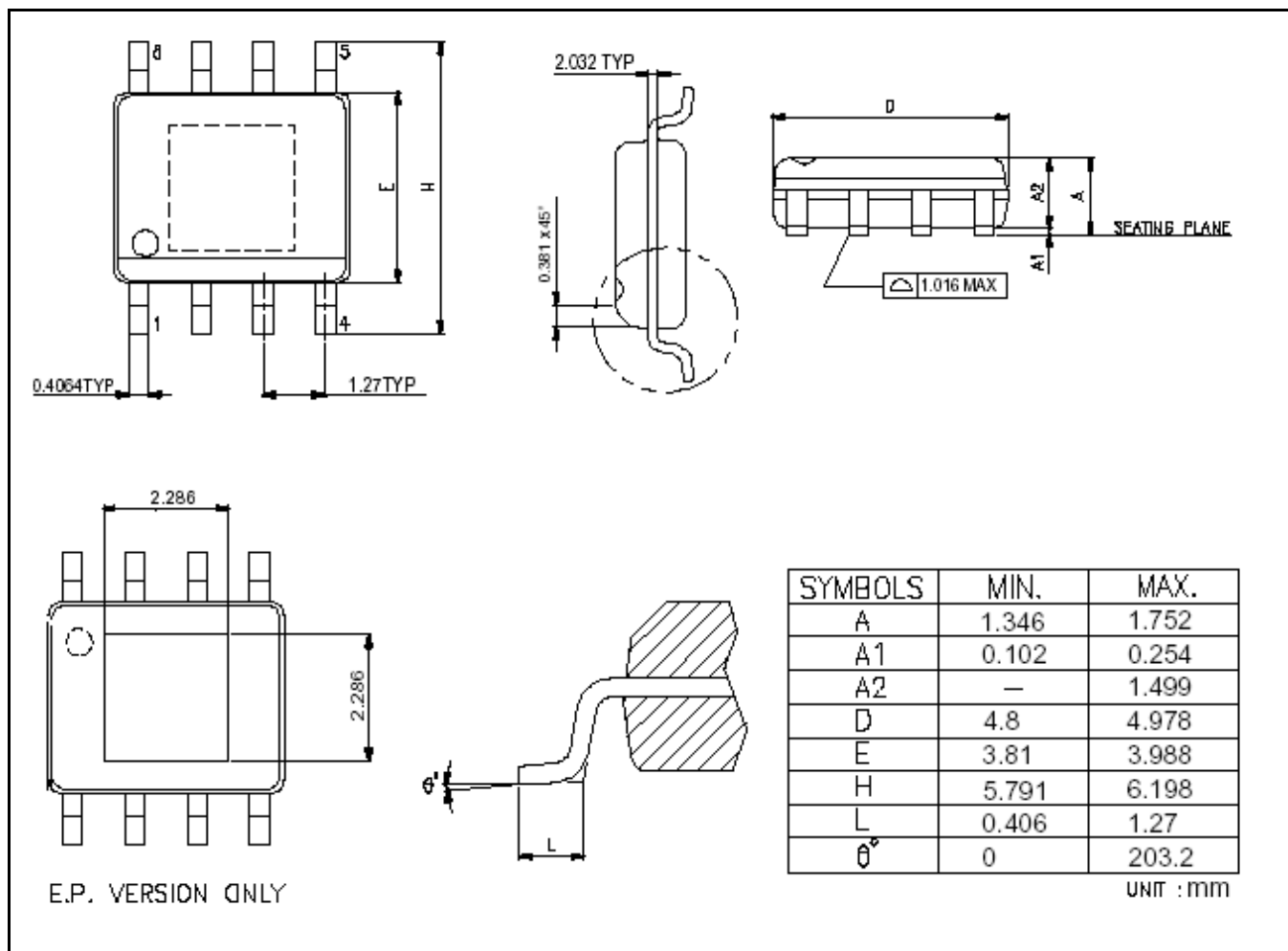

MBI6656 GD Outline Drawing

Note: Please use the maximum dimensions for the thermal pad layout. To avoid the short circuit risk, the vias or circuit traces shall not pass through the maximum area of thermal pad.

Product Top Mark Information

GST(SOT-23-6L)/ G (SOP-8L)

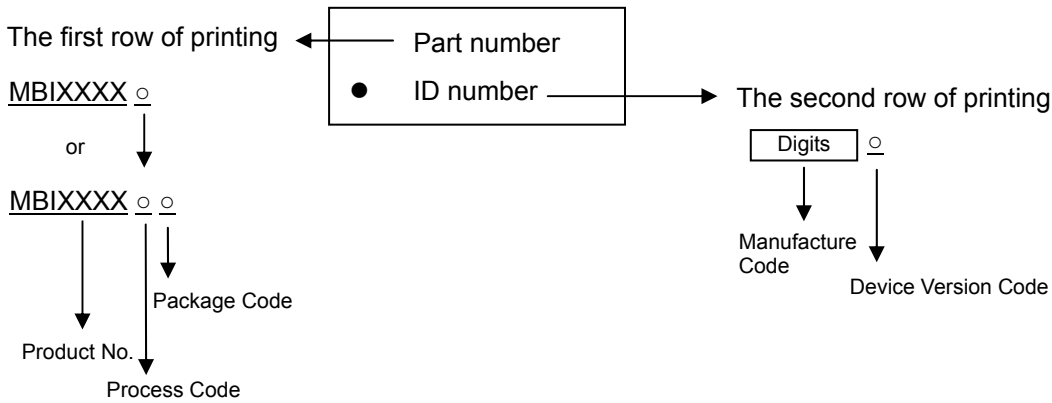

GSD(TO-252-5L)/ GSB(SOT-89-5L)

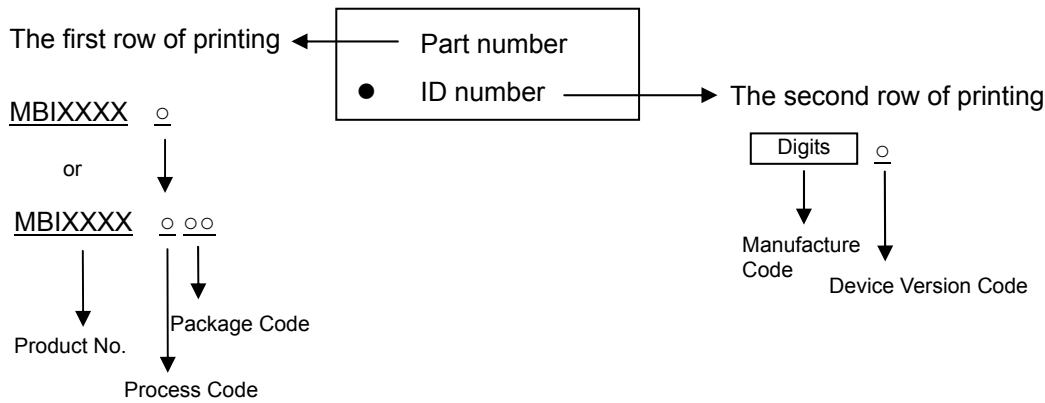

Product Revision History

Datasheet Version	Device Version Code
V1.00	A

Product Ordering Information

Product Ordering Number*	RoHS Compliant Package Type	Weight (g)
MBI6656GSD-A	TO-252-5L	0.282
MBI6656GST-A	SOT-23-6L	0.016
MBI6656GSB-A	SOT-89-5L	0.080
MBI6656GD-A	SOP8L-150-1.27	0.079

*Please place your order with the **“product ordering number”** information on your purchase order (PO).

Disclaimer

Macroblock reserves the right to make changes, corrections, modifications, and improvements to their products and documents or discontinue any product or service. Customers are advised to consult their sales representative for the latest product information before ordering. All products are sold subject to the terms and conditions supplied at the time of order acknowledgement, including those pertaining to warranty, patent infringement, and limitation of liability.

Macroblock's products are not designed to be used as components in device intended to support or sustain life or in military applications. Use of Macroblock's products in components intended for surgical implant into the body, or other applications in which failure of Macroblock's products could create a situation where personal death or injury may occur, is not authorized without the express written approval of the Managing Director of Macroblock. Macroblock will not be held liable for any damages or claims resulting from the use of its products in medical and military applications.

All text, images, logos and information contained on this document is the intellectual property of Macroblock. Unauthorized reproduction, duplication, extraction, use or disclosure of the above mentioned intellectual property will be deemed as infringement.