

Features :

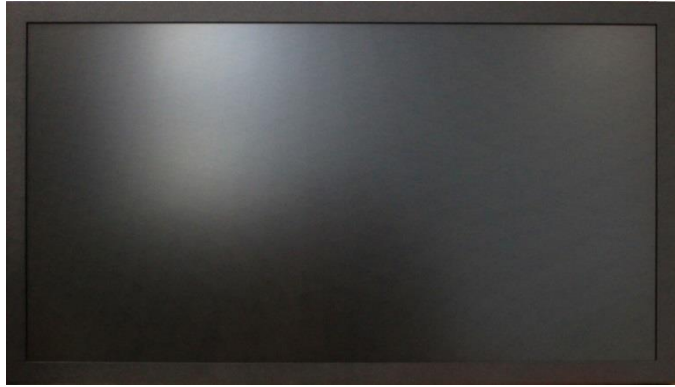

- ★ Made in Taiwan
- ★ FHD 1920x1080
- ★ Wide Viewing Angle 178° /178°
- ★ Brightness Options : 250/800/1600 nits
- ★ Touchscreen options : Capacitive/Resistive/IR
- ★ Display Connector Options : VGA/DVI/HDMI
- ★ Metal Enclosed Cabinet
- ★ Open-frame Brackets , Wall Mount Bracket , Desktop Stand
- ★ Splash Proof, Vandal Proof, AG/AR/AFP Options

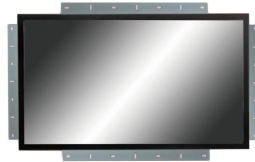

Display Specification			
Model No.	NTM215	Resolution	1920x1080 (FHD)
Screen Diagonal	546.9 mm (21.53 inch)	Brightness	250 nits (optional)
Active Area	476.64x268.11 mm	Contrast Ratio	3000:1
Pixel Pitch	248.25x248x25 um	Viewing Angle (L/R)	178° (CR=10)
Display Color	16.7M Color	Viewing Angle (U/D)	178° (CR=10)
Display Ratio	16:9	Response Time	18 msec
Backlight Unit	LED	Surface Treatment	Anti-glare, Hardness 3H
Operating Temp.	0-50°C		
General Specification			
Speaker	2Wx2	Power supply	External Adapter 12V/5A

Display Input options.	
Connectors	Model No.
(Standard) VGA+DVI	NTM215XXXXXXG
VGA+HDMI	NTM215XXXXXXT
VGA+DVI+HDMI	NTM215XXXXXX7

Touchscreen Options.	
Type	Model No.
No touch	NTM2150XXXXXX
Projected Capacitive	NTM215YXXXXXX
Surface Capacitive	NTM215CXXXXXX
Resistive	NTM2155XXXXXX
I.R	NTM215IXXXXXXX

Touchscreen Specification

Type	Touch Points	Transparency	Precision	Hardness	Surface Treatment	Interface
Projected Capacitive	10	≥85%	2.5mm ±10%	≥7H	(none)	USB
Surface Capacitive	1	≥92% ±3%	99%	≥9H	Anit-glare <7%	USB & RS232
Resistive *	1	80% ±5%	98.5%	≥3H	Anit-glare <15%	USB & RS232
I.R	6	≥92% ±3%	≤2.5mm	≥7H	(none)	USB

* Pressure Sensitive of Resistive touchscreen : 50g

Dimension

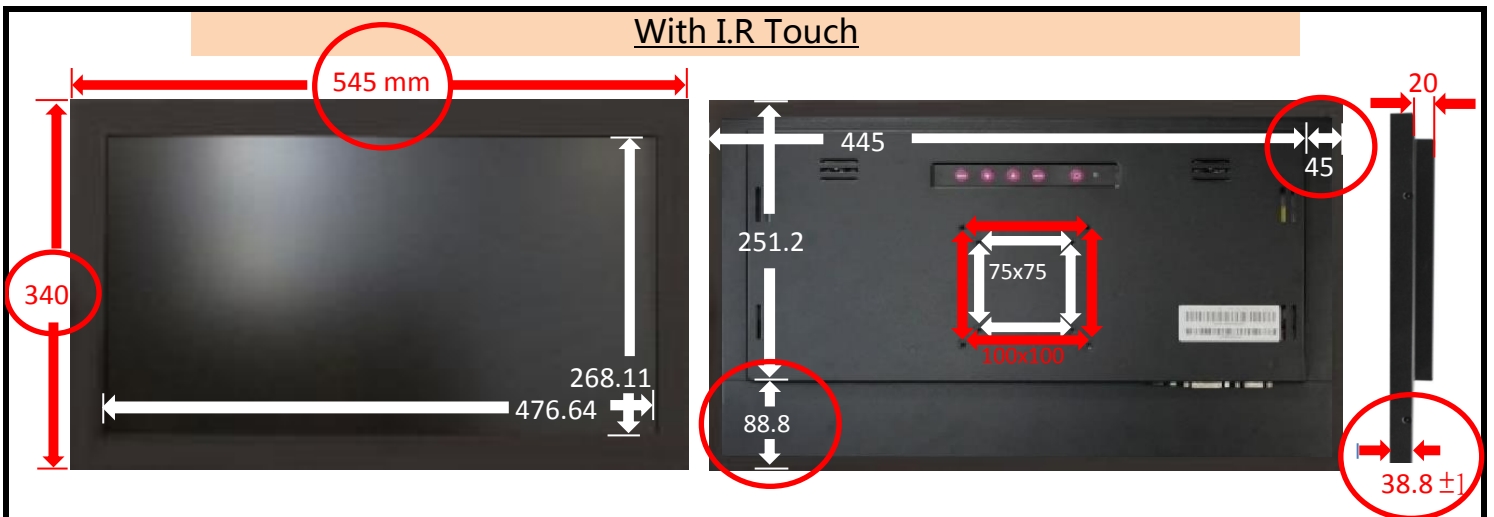
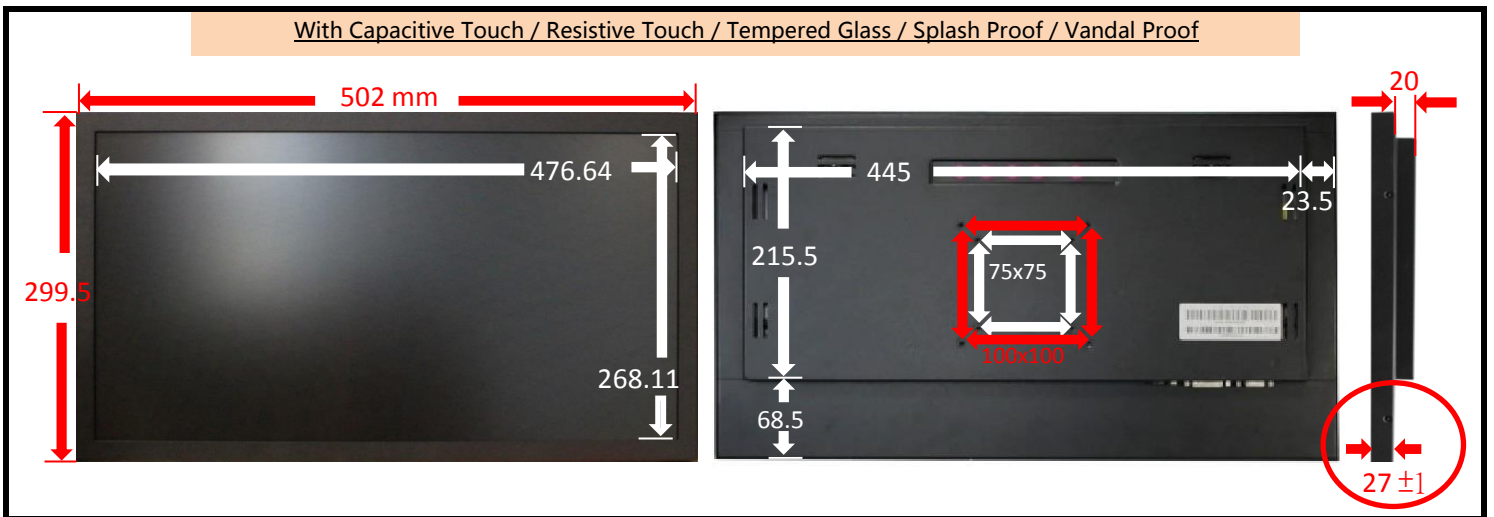
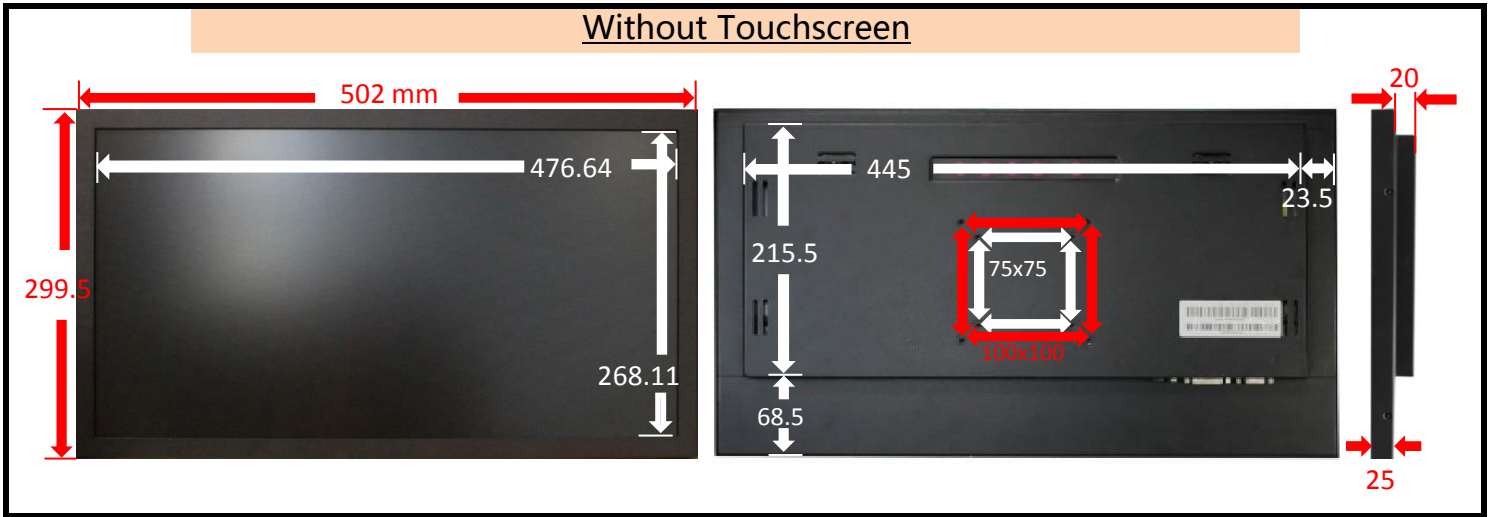

Physical Specification

Type	Dimension	Net Weight (KG)	
No Touch	(page.2)	4.1	
Projected Capacitive	(page.2)	4.7	
Surface Capacitive	(page.2)	5.1	
Resistive	(page.2)	5.2	
I.R	(page.2)	7.9	

Brightness Options

Brightness	Model No.
(Standard) 250nits	NTM215XXXXNXX
800 nits	NTM215XXXX8XX
1600 nits	NTM215XXXXGXX

Other Customization Options

Surface Film : AG , AR , AFP Film	Color : Any Color (requires MOQ 100+)
Vandal Proof : Tempered Glass Hardness 7H	Splash Proof : IP 65 Compliant Front Panel

Carton

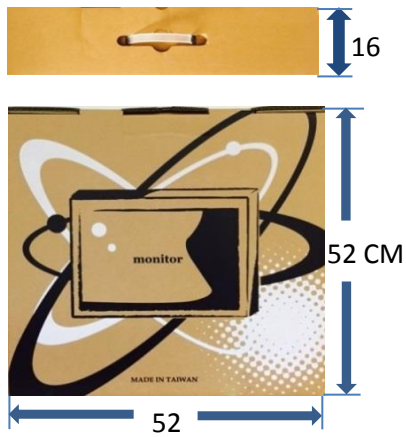

* Weight of Carton and EPE protection : 1KG

Coding Rule

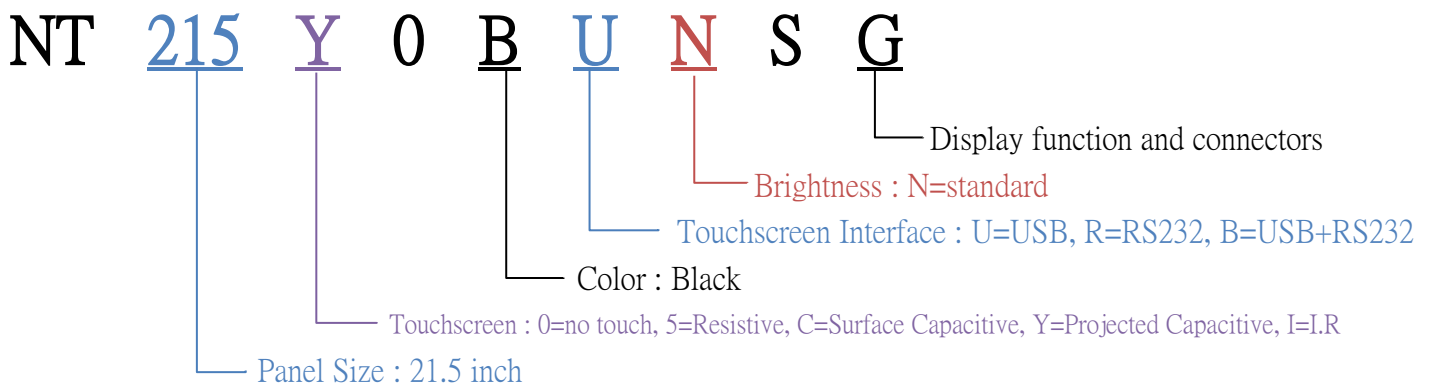

Desktop Stand (Optional)



Open-frame Brackets (Optional)

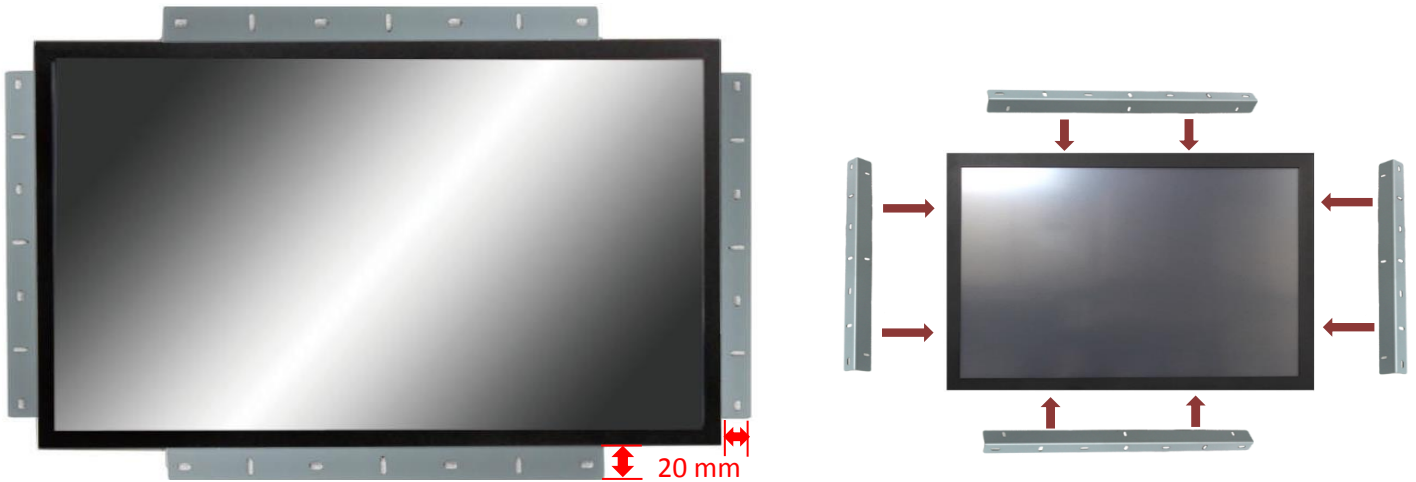

Panel Mounted Bezel (customized option)

