

REV.	ECN NO.	DATE	SIGN	DESCRIPTION
B	LEN1580154-165	2015-08-10	Feng_Li	Add Black PVC Cable

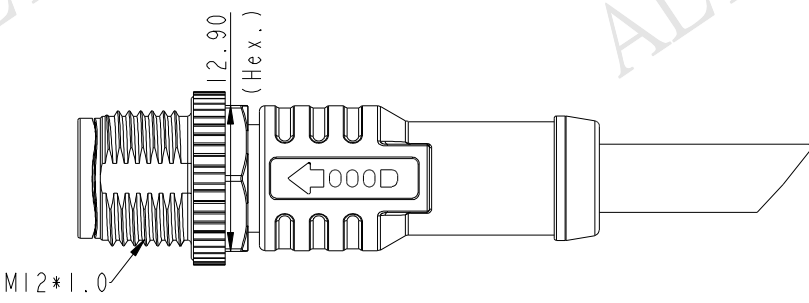
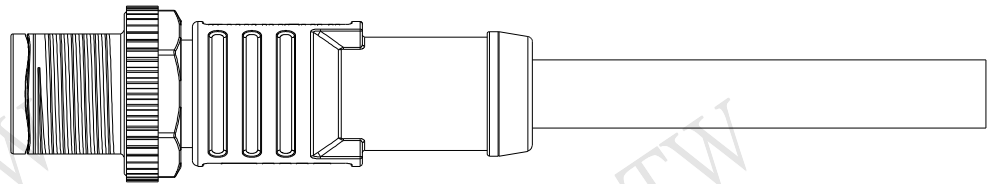
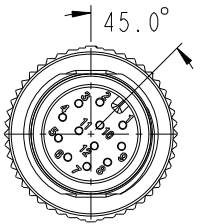
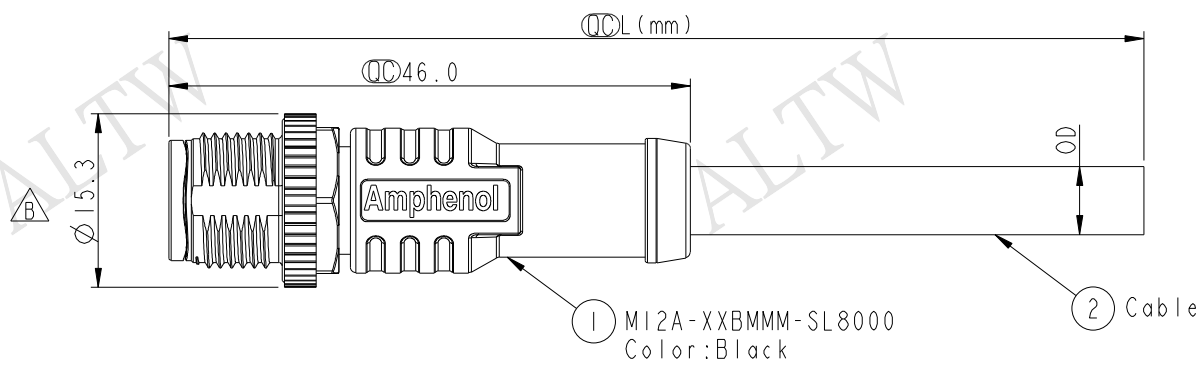

**ALTW**  
**CONFIDENTIAL**  
 2015-08-10  
**R&D DEPT.**

**ALTW**  
 DCC. DEPT.  
 CONFIDENTIAL  
 2015.08.14  
**ISSUED**

- Notes:
- \*  $\varnothing$  Important Dimension.
  - \* Waterproof Rate: IP68.
  - \* Connector: PU+GF, Black.
  - \* Male Pin: Copper Alloy, Gold Plated.
  - \* Screw Nut: Zinc Alloy, Nickel Plated.
  - \* Outer Mold: PU, Black.
  - \* Cable: (A) UL2517, PVC Jacket, Yellow.  
 (B) UL20549, PUR Jacket, Black.  
 (D) UL2517, PVC Jacket, Black.
  - \* Rated Voltage: 3 & 4Pin 250V dc. or ac.  
 5Pin 60V dc. or ac.  
 6~12Pin 30V dc. or ac.
  - \* Rated Current: 3~5Pin 4A  
 6~8Pin 2A  
 10~12Pin 1.5A
  - \* Operating Temperature: -25~85°C
  - \* Cable Length Tolerance: 01M:±40mm  
 02M~05M:±60mm  
 06M~10M:±100mm  
 11M~30M:±200mm  
 31M~99M:±500mm

UNIT: mm  
 TOLERANCE  
 ±0.5mm

TITLE M12 A Type Cable Male Conn.			
SCALE 3:2	SIZE A4	SHEET 1 OF 2	
REV. B	WC-REV. A.3	$\varnothing$ : Inspection item	

**Amphenol LTW**  
 安費諾亮泰企業股份有限公司

ITEM NO.	DRAWN BY Feng_Li	DATE 2015-08-10
DWG NO. M12A-XXBMMM-SL8XXX	CHECKED BY Cary	DATE 2015-08-10
CUSTOMER ALTW	APPROVED BY Jerry	DATE 2015-08-10

THIS DOCUMENT IS SUBJECT TO CHANGE WITHOUT NOTICE. IT IS CONFIDENTIAL AND A PROPERTY OF Amphenol LTW. DISCLOSURE TO THIRD PARTY HAS TO BE AUTHORIZED BY Amphenol LTW.

THIS DOCUMENT IS SUBJECT TO CHANGE WITHOUT NOTICE. IT IS CONFIDENTIAL AND A PROPERTY OF Amphenol LTW. DISCLOSURE TO THIRD PARTY HAS TO BE AUTHORIZED BY Amphenol LTW.

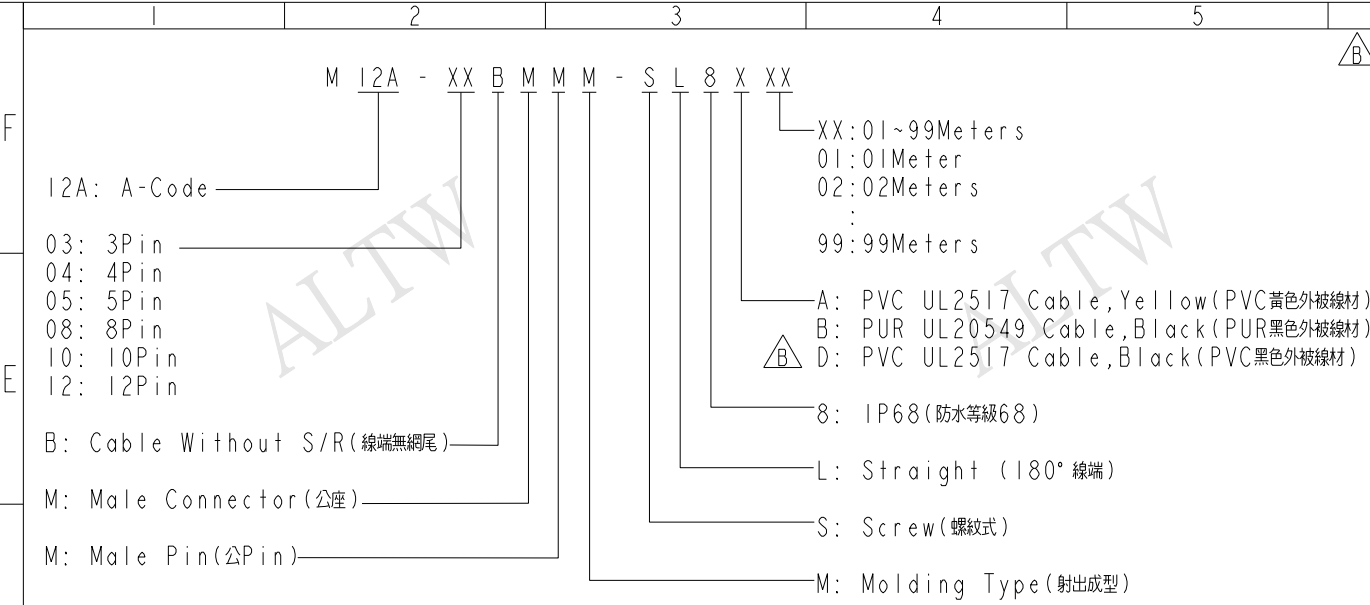

12P	PVC	6.0	26	M12A-12BMMM-SL8DXX
10P				M12A-10BMMM-SL8DXX
8P		5.5	24	M12A-08BMMM-SL8DXX
5P				M12A-05BMMM-SL8DXX
4P				M12A-04BMMM-SL8DXX
3P	4.1	M12A-03BMMM-SL8DXX		
12P	PUR	6.0	26	M12A-12BMMM-SL8BXX
10P				M12A-10BMMM-SL8BXX
8P		5.5	24	M12A-08BMMM-SL8BXX
5P				M12A-05BMMM-SL8BXX
4P				M12A-04BMMM-SL8BXX
3P	4.5	M12A-03BMMM-SL8BXX		
12P	PVC	6.0	26	M12A-12BMMM-SL8AXX
10P				M12A-10BMMM-SL8AXX
8P		5.5	24	M12A-08BMMM-SL8AXX
5P				M12A-05BMMM-SL8AXX
4P				M12A-04BMMM-SL8AXX
3P	4.5	M12A-03BMMM-SL8AXX		
Contacts	Cable Jacket	Cable OD	AWG	Item No.

5	--	5	--	5	Gray	灰	5	Gray	灰	5	Red/Blue	紅/藍			
4	Black	黑	4	Black	黑	4	Black	黑	4	Black	黑	4	Gray/Pink	灰/粉	
3	Blue	藍	3	Blue	藍	3	Blue	藍	3	Blue	藍	3	Violet	紫	
2	--		2	White	白	2	White	白	2	White	白	2	Black	黑	
1	Brown	棕	1	Brown	棕	1	Brown	棕	1	White	白	1	Red	紅	
													8	Red	紅
													7	Blue	藍
													6	Pink	粉
													5	Gray	灰
													4	Yellow	黃
													3	Green	綠
													2	Brown	棕
													1	White	白

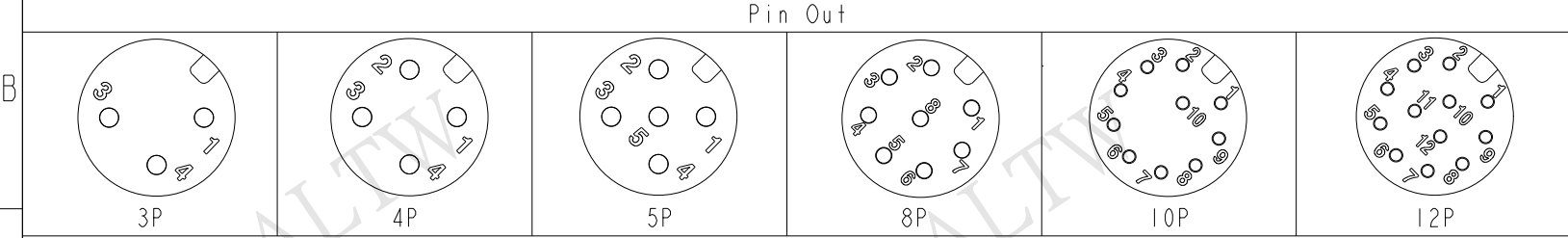
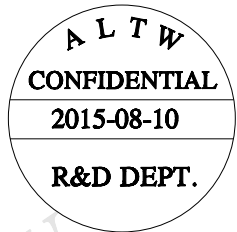

Pin Assignments Front View

UNIT:mm TOLERANCE ±0.5mm	TITLE M12 A Type Cable Male Conn.		<b>Amphenol LTW</b> 安費諾亮泰企業股份有限公司		ITEM NO	DRAWN BY	DATE
	SCALE 3:2	SIZE A4			SHEET 2 OF 2	DWG NO M12A-XXBMMM-SL8XXX	CHECKED BY Cary
	REV. B	WC-REV. A.3	QC: Inspection item	CUSTOMER ALTW	APPROVED BY Jerry	DATE 2015-08-10	