

Stamped contacts Crimp female contacts diameter 1,6 mm for wire gauge AWG 20 - 16 silver plated

Part No. VN02 016 0002 1

Series Contacts

Subseries Contact Stamped contacts



COMMON CHARACTERISTICS		
Contact diameter		1,6 mm
Insulation diameter		1,8 - 2,8 mm
Wire gauge from		0,5
Wire gauge to		1,5
Wire gauge (AWG) from		20
Wire gauge (AWG) to		16
Packaging / supplied as		Single contact
No. of pieces		100
Sex of Contact		Socket
Type of contact		Stamped/rolled crimp contact
ELECTRICAL CHARACTERISTICS		
Contact resistance	DIN EN 60512-2-1, Test 2a / IEC 60512-2-1, Test 2a	< 5 m

Stamped contacts Crimp female contacts diameter 1,6 mm for wire gauge AWG 20 - 16 silver plated

Part No. VN02 016 0002 1

Series Contacts

Subseries Contact Stamped contacts

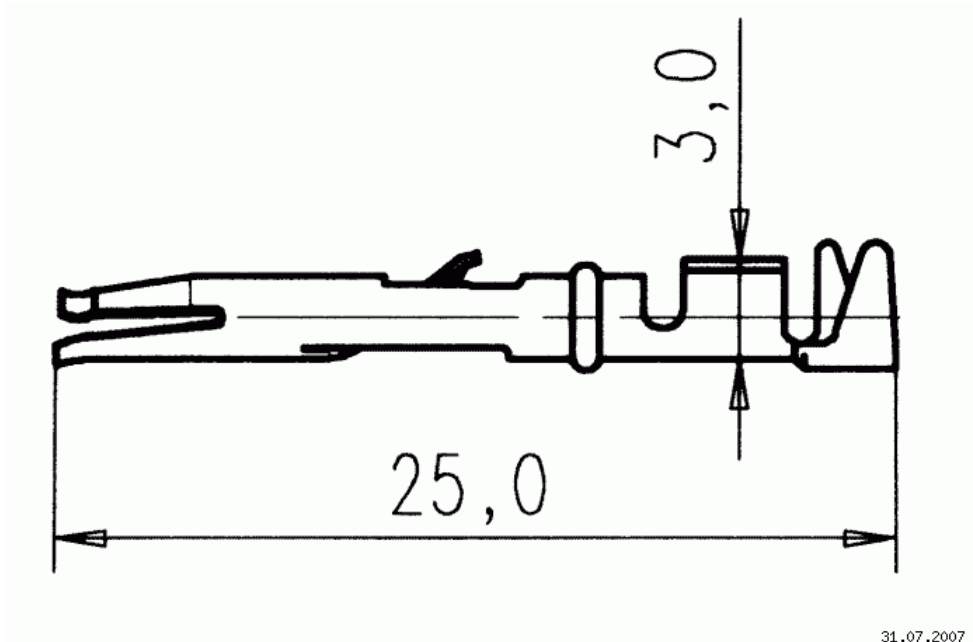

Drawing Dimensions in mm (Inch)

31.07.2007

Stamped contacts Crimp female contacts diameter 1,6 mm for wire gauge AWG 20 - 16 silver plated

Part No. VN02 016 0002 1

Series Contacts

Subseries Contact Stamped contacts



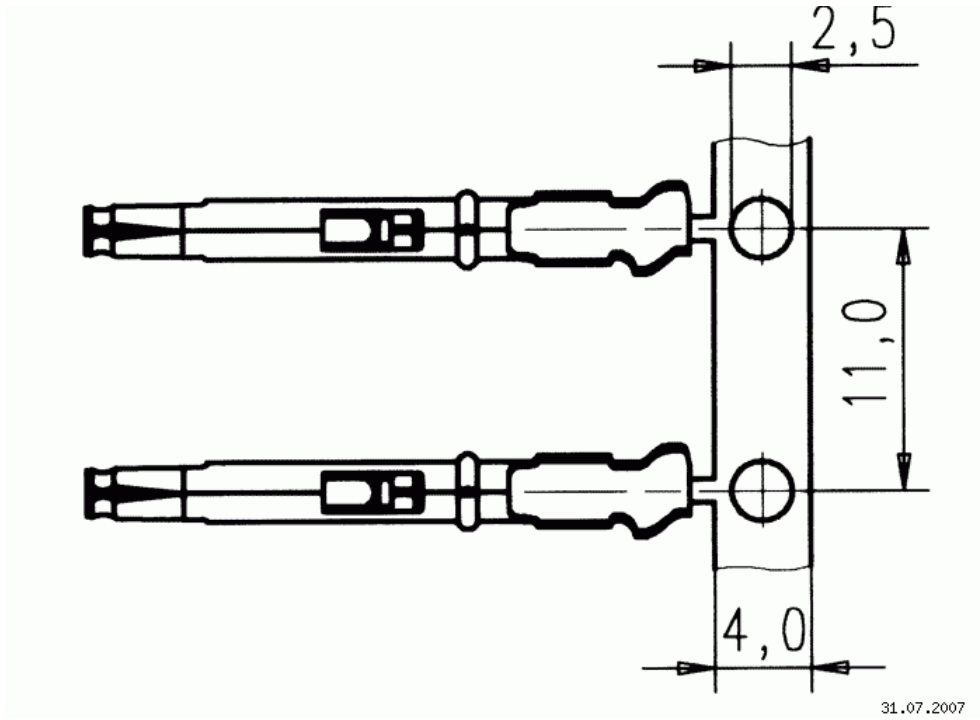

Panel cutout

31.07.2007