

## LISA2-WWW-PIN

~80° wide beam. 7.0 mm high variant with location pin installation.

### SPECIFICATION:

Dimensions	Ø 9.9 mm
Height	7 mm
Fastening	glue, pin
ROHS compliant	yes ⓘ



### MATERIALS:

Component	Type	Material	Colour	Finish
LISA2-WWW	Single lens	PMMA	clear	
LISA2-HLD-PIN	Holder	PC	black	

### ORDERING INFORMATION:

Component		Qty in box	MOQ	MPQ	Box weight (kg)
FP11429_LISA2-WWW-PIN	Single lens	2000		100	1.4
» Box size:					

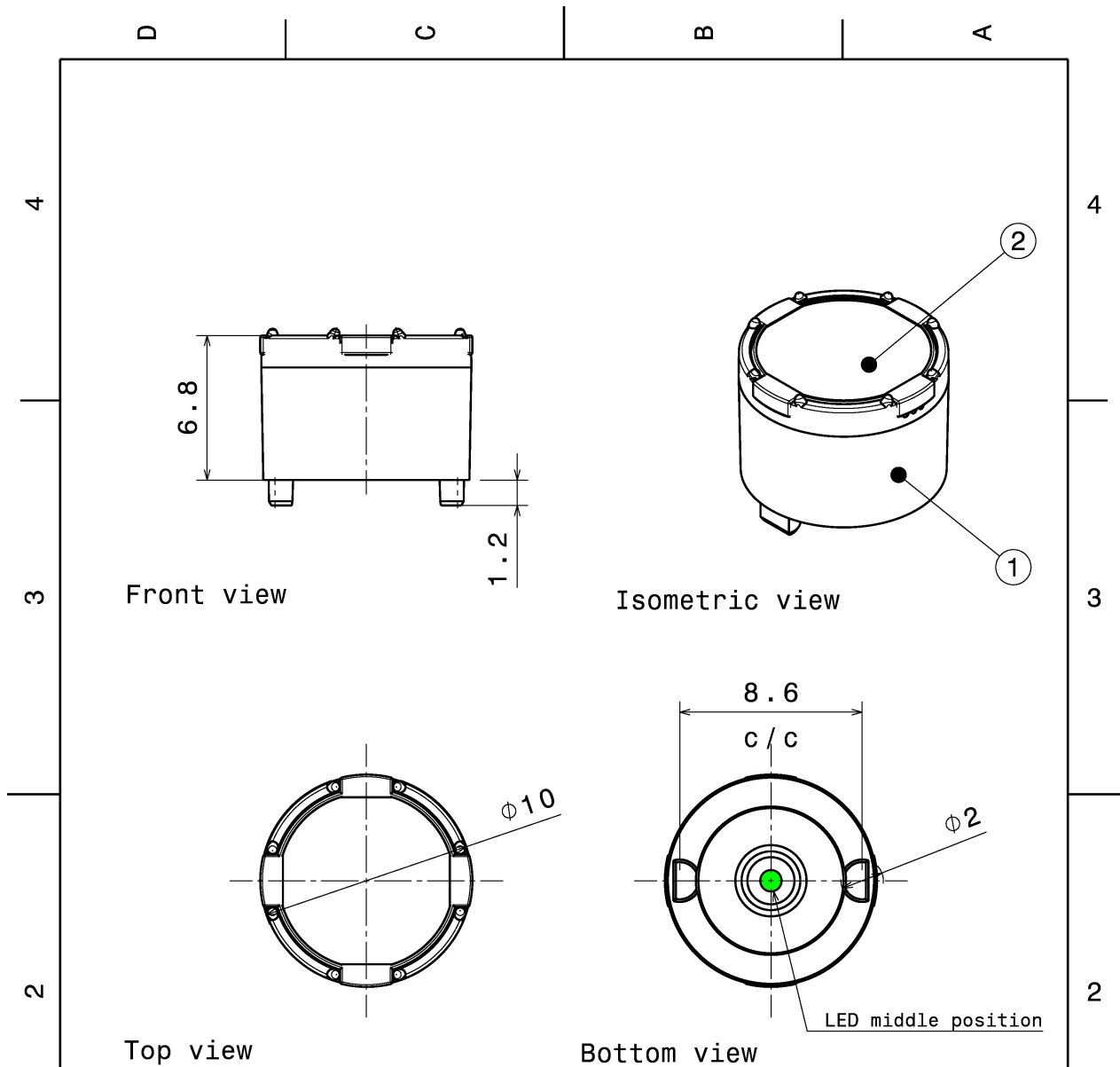

INDEX	PART NO	DESCRIPTION	MATERIAL	COLOUR
1	F10989	LISA2-HLD-PIN	PC	black
2	-	LISA2_lens	PMMA	

Tolerances if not otherwise shown  
According to DIN ISO 2768-1  
Linear measures:  
up to 30mm class M, otherwise class C  
According to DIN ISO 2768-2  
Form and position: class L

**LEDiL** Ledil Oy  
Salorankatu 10  
FIN 24240 SALO  
Finland

THIRD ANGLE PROJECTION:

DRAWING TITLE  
**Lisa2-PIN-XP assembly**

This drawing is the property of LEDiL Oy. It may not be reproduced, copied or communicated without a written agreement with LEDiL Oy.

SIZE	PART NUMBER
A4	-

SCALE	4:1	WEIGHT	0,5 g	SHEET	1/1
-------	-----	--------	-------	-------	-----

See also our general installation guide: [www.ledil.com/installation\\_guide](http://www.ledil.com/installation_guide)

#### OPTICAL RESULTS (MEASURED):



LED XD16  
 FWHM / FWTM 66.0° / 110.0°  
 Efficiency 66 %  
 Peak intensity 0.6 cd/lm  
 LEDs/each optic 1  
 Light colour White  
 Required components:

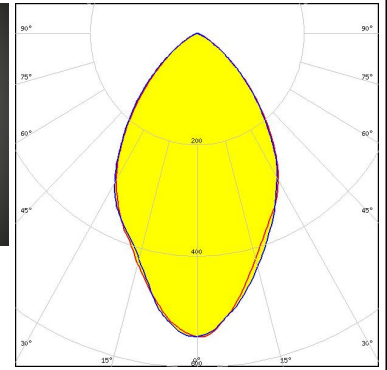
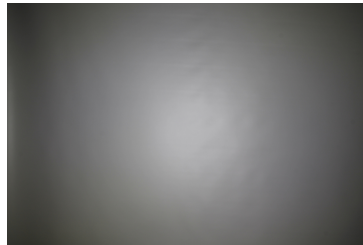

LED XP-E  
 FWHM / FWTM 84.0°  
 Efficiency 77 %  
 Peak intensity 0.5 cd/lm  
 LEDs/each optic 1  
 Light colour White  
 Required components:

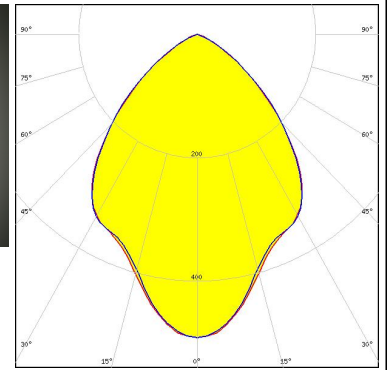
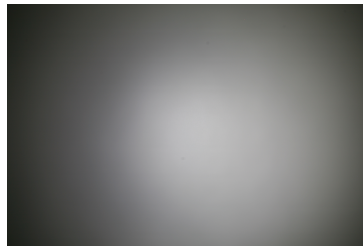

LED XP-G  
 FWHM / FWTM 86.0° / 126.0°  
 Efficiency 75 %  
 Peak intensity 0.4 cd/lm  
 LEDs/each optic 1  
 Light colour White  
 Required components:

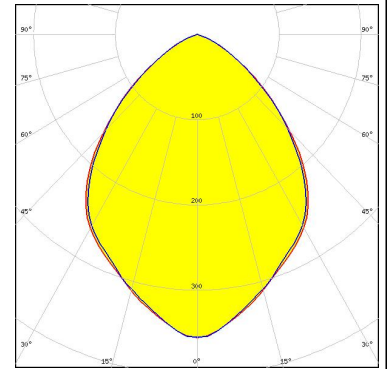

LED LUXEON A  
 FWHM / FWTM 86.0° / 122.0°  
 Efficiency 72 %  
 Peak intensity 0.3 cd/lm  
 LEDs/each optic 1  
 Light colour White  
 Required components:

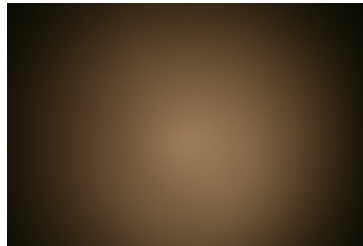

#### OPTICAL RESULTS (MEASURED):

##### LUMILEDS

LED LUXEON Rebel ES  
FWHM / FWTM 88.0°  
Efficiency %  
LEDs/each optic 1  
Light colour White  
Required components:

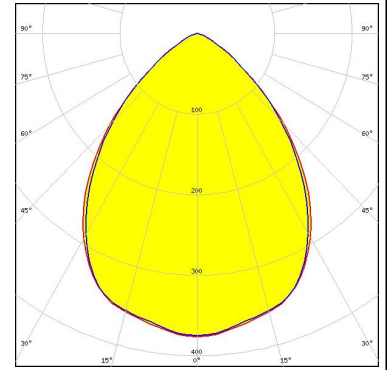

##### LUMILEDS

LED LUXEON Z  
FWHM / FWTM 73.0° / 106.0°  
Efficiency 75 %  
Peak intensity 0.6 cd/lm  
LEDs/each optic 1  
Light colour White  
Required components:



##### NICHIA

LED NVSxE21A  
FWHM / FWTM 53.0° / 98.0°  
Efficiency 70 %  
Peak intensity 0.8 cd/lm  
LEDs/each optic 1  
Light colour White  
Required components:

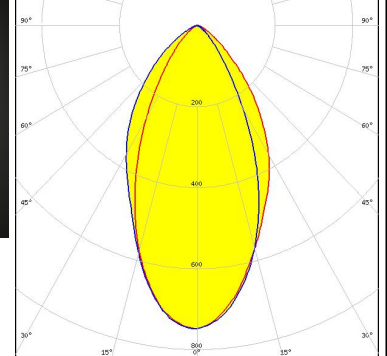
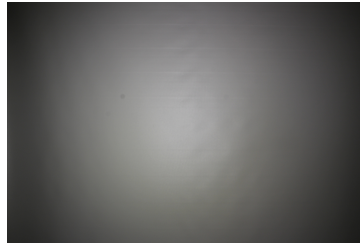

##### OSRAM

Opto Semiconductors

LED SFH 4170S  
FWHM / FWTM 58.0° / 114.0°  
Efficiency %  
LEDs/each optic 1  
Light colour IR  
Required components:

#### OPTICAL RESULTS (MEASURED):

#### OSRAM

Opto Semiconductors

LED SFH 4180S  
FWHM / FWTM 57.0° / 112.0°  
Efficiency %  
LEDs/each optic 1  
Light colour IR  
Required components:

#### SAMSUNG

LED LH181B  
FWHM / FWTM 62.0° / 104.0°  
Efficiency 72 %  
Peak intensity 0.6 cd/lm  
LEDs/each optic 1  
Light colour White  
Required components:

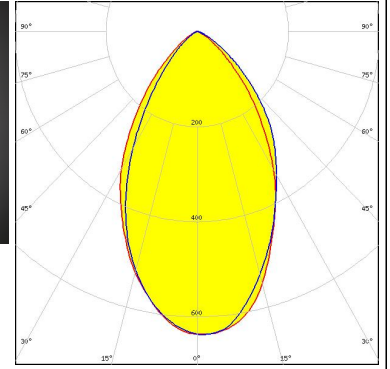

#### OPTICAL RESULTS (SIMULATED):

<p><b>bridgelux</b></p> <p>LED CSP 2323 (BXCP)</p> <p>FWHM / FWTM 61.0° / 111.0 + 112.0°</p> <p>Efficiency 83 %</p> <p>Peak intensity 0.7 cd/lm</p> <p>LEDs/each optic 1</p> <p>Light colour White</p> <p>Required components:</p>	
<p><b>CREE LEDs</b></p> <p>LED XB-D</p> <p>FWHM / FWTM 53.0° / 104.0°</p> <p>Efficiency 73 %</p> <p>Peak intensity 0.8 cd/lm</p> <p>LEDs/each optic 1</p> <p>Light colour White</p> <p>Required components:</p>	
<p><b>CREE LEDs</b></p> <p>LED XQ-E HD</p> <p>FWHM / FWTM 70.0° / 126.0°</p> <p>Efficiency 81 %</p> <p>Peak intensity 0.6 cd/lm</p> <p>LEDs/each optic 1</p> <p>Light colour White</p> <p>Required components:</p>	
<p><b>LUMILEDS</b></p> <p>LED LUXEON IR 2720</p> <p>FWHM / FWTM 58.0° / 101.0°</p> <p>Efficiency 76 %</p> <p>Peak intensity 0.8 cd/lm</p> <p>LEDs/each optic 1</p> <p>Light colour IR</p> <p>Required components:</p>	

#### OPTICAL RESULTS (SIMULATED):

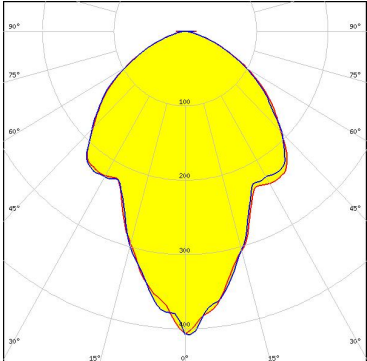
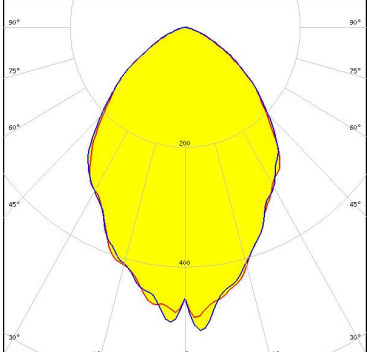
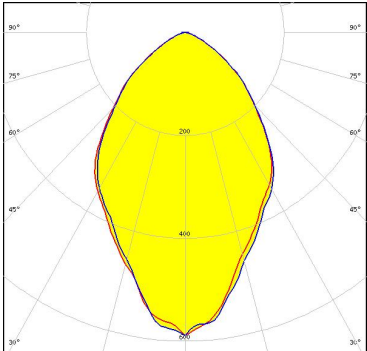
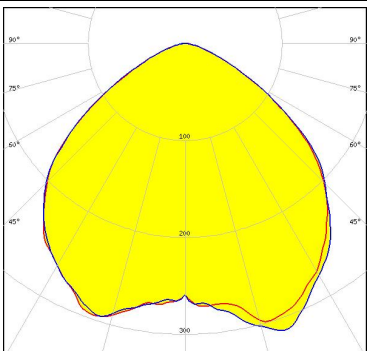
<p><b>LUMILEDS</b></p> <p>LED LUXEON SunPlus 20 Line (150 deg)</p> <p>FWHM / FWTM 84.0° / 140.0°</p> <p>Efficiency 73 %</p> <p>Peak intensity 0.4 cd/lm</p> <p>LEDs/each optic 1</p> <p>Light colour White</p> <p>Required components:</p>	
<p><b>LUMILEDS</b></p> <p>LED LUXEON TX</p> <p>FWHM / FWTM 80.0° / 130.0°</p> <p>Efficiency 83 %</p> <p>Peak intensity 0.5 cd/lm</p> <p>LEDs/each optic 1</p> <p>Light colour White</p> <p>Required components:</p>	
<p><b>LUMINUS</b></p> <p>LED SST-20</p> <p>FWHM / FWTM 73.0° / 122.0°</p> <p>Efficiency 86 %</p> <p>Peak intensity 0.6 cd/lm</p> <p>LEDs/each optic 1</p> <p>Light colour White</p> <p>Required components:</p>	
<p><b>NICHIA</b></p> <p>LED NVSW519A</p> <p>FWHM / FWTM 104.0° / 140.0°</p> <p>Efficiency 76 %</p> <p>Peak intensity 0.3 cd/lm</p> <p>LEDs/each optic 1</p> <p>Light colour White</p> <p>Required components:</p>	

#### OPTICAL RESULTS (SIMULATED):

##### OSRAM

Opto Semiconductors

LED OSLOM SSL 120  
 FWHM / FWTM 86.0° / 123.0°  
 Efficiency 87 %  
 Peak intensity 0.5 cd/lm  
 LEDs/each optic 1  
 Light colour Amber  
 Required components:

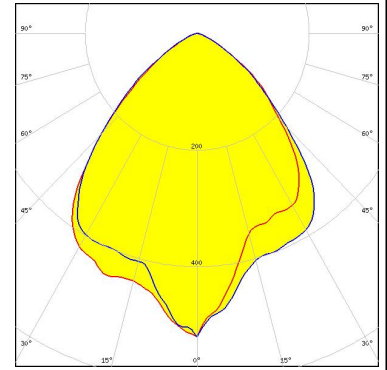

##### OSRAM

Opto Semiconductors

LED SFH 4715AS  
 FWHM / FWTM 52.0° / 102.0°  
 Efficiency 88 %  
 LEDs/each optic 1  
 Light colour IR  
 Required components:

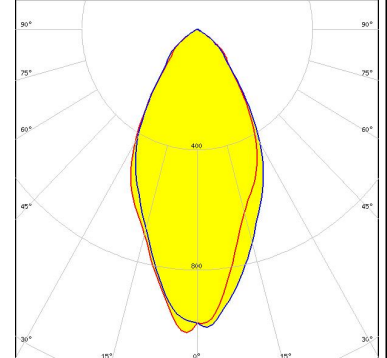
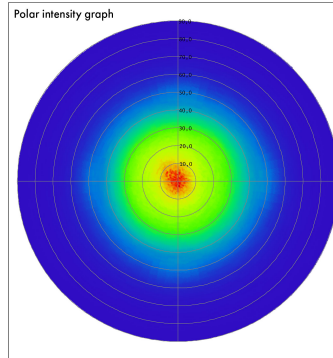

##### SAMSUNG

LED LM301B  
 FWHM / FWTM 80.0° / 122.0°  
 Efficiency 86 %  
 Peak intensity 0.5 cd/lm  
 LEDs/each optic 1  
 Light colour White  
 Required components:

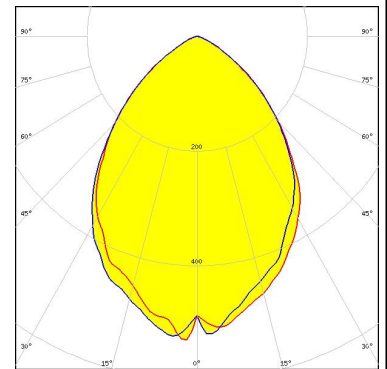

SEOUL SEMICONDUCTOR

LED Z5  
 FWHM / FWTM 70.0°  
 Efficiency %  
 LEDs/each optic 1  
 Light colour White  
 Required components:



### GENERAL INFORMATION:

NOTE: The typical beam angle will be changed by different color, chip size and chip position tolerance. The typical total beam angle is the full angle measured where the luminous intensity is half of the peak value.

### MATERIALS:

As part of our continuous research and improvement processes, and to ensure the best possible quality and availability of our products, LEDiL reserves the right to change material grades without notice.

### PRODUCT DATA USER AGREEMENT AND DISCLAIMER:

The measured data in the provided downloadable LEDiL Product Datasheets and Mechanical 2D-Drawings is rounded and provided as reference for planning. LEDiL Oy's optical specifications have been verified by conducting performance testing of the products in accordance with the company's quality system. The reported data are averaged results of multiple measurements with typical variation. LEDiL Oy reserves the right to without prior notification make changes and improvements to its products.

LEDiL Oy assumes neither warranty, nor guarantee nor any other liability of any kind for the contents and correctness of the provided data. The provided data has been generated with highest diligence but the provided data may in reality not represent the complete possible variation range of all intrinsic parameters. Therefore, in certain cases a deviation from the provided data could occur.

LEDiL Oy reserves the right to undertake technical changes of its products without further notification which could lead to changes in the provided data. LEDiL Oy assumes no liability of any kind for the possible deviation from any provided data or any other damage resulting from the usage of the provided data.

The user agrees to this disclaimer and user agreement with the download or usage of the provided files.

#### LEDiL Oy

Joensuunkatu 13  
FI-24240 SALO  
Finland

#### LEDiL Inc.

228 West Page Street  
Suite D  
Sycamore IL 60178  
USA

#### Ledil Optics Technology (Shenzhen) Co., Ltd.

# 405 , Block B  
Casic Motor Building  
Shenzhen 518057  
P.R.CHINA

#### Local sales and technical support

[www.ledil.com/  
where\\_to\\_buy](http://www.ledil.com/where_to_buy)

#### Shipping locations

Salo, Finland  
Hong Kong, China

#### Distribution Partners

[www.ledil.com/  
where\\_to\\_buy](http://www.ledil.com/where_to_buy)