

DETAILS

Product Number	CA10925_STRADA-B
Family	Strada-B
Type	Assembly
Color	clear
Diameter	19,6 + 15,5 mm
Height	8,2 mm
Style	rectang
Optic Material	PMMA
Holder Material	
Fastening	screw, tape
Status	production ready
ROHS Compliant	Yes
Date Updated	10/06/2014



OPTICAL PROPERTIES

LED	Viewing Angle	Light Beam	Efficiency	cd/lm	Connector
XR-E	84+36 deg	Streetligh...	93 %	1.020	-
XM-L	97+46 deg	Streetligh...	88 %	0.460	-

D

C

B

A

4

4

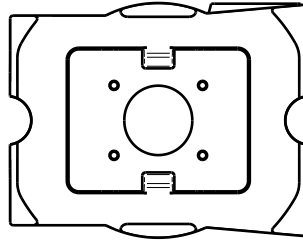

3

3

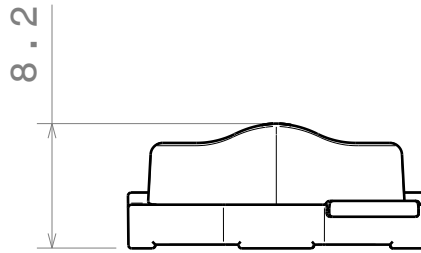

2

2

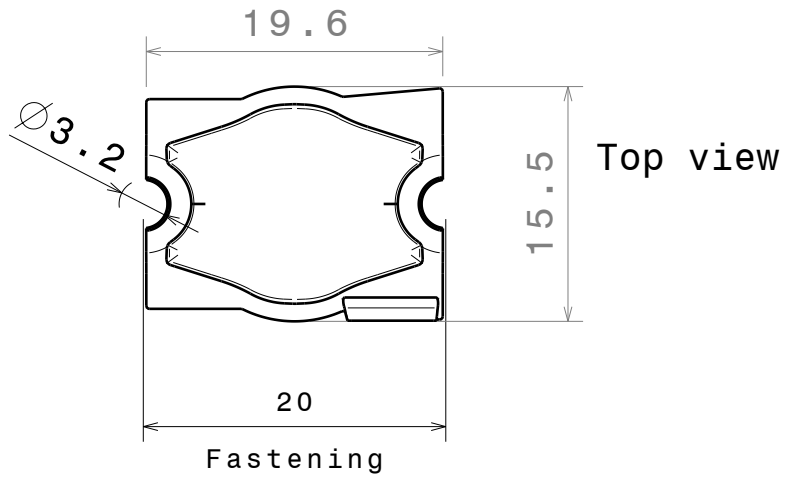

MATERIAL PMMA

This drawing is our property.
It can't be reproduced
or communicated without
our written agreement.



L
T
F
F

e
e
i
i
N
n

d

h

DRAWING TITLE

Datasheet Strada-B-XR lens

DRAWN BY

DATE

p

13.08.2009

CHECKED BY

DATE

t

k

26.04.2009

DESIGNED BY

DATE

hh

26.04.2009

SIZE

A4

DRAWING NUMBER

C10924

REV

0.1

SCALE

2:1

WEIGHT (g)

SHEET

1/1

D

A

1

1

Ledil Oy C10924_Strada-B-XR C10924_Strada-B-XR / LDC (Linear)

Luminaire: Ledil Oy C10924_Strada-B-XR C10924_Strada-B-XR
Lamps: 1 x Cree XR-E (white)

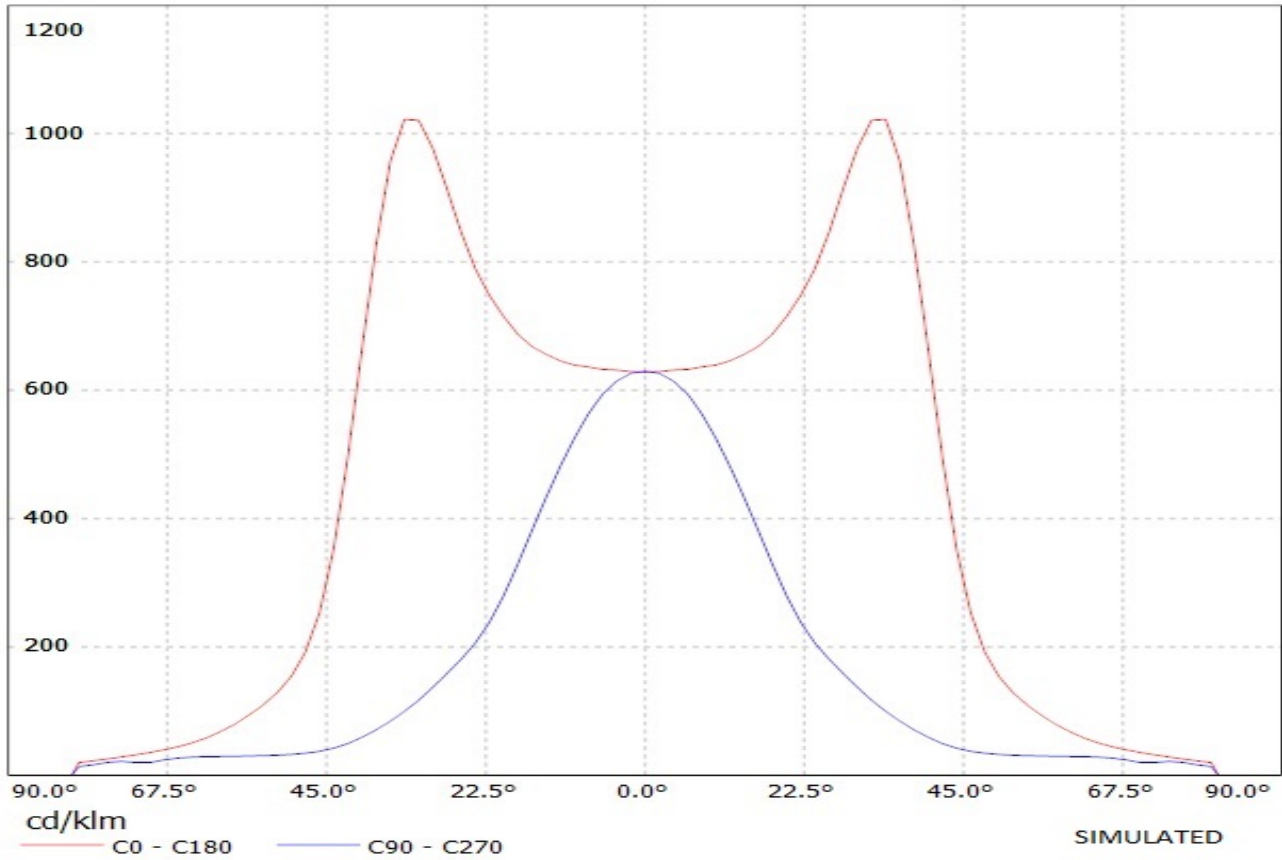

Ledil CA10925 STRADA-B_(XM-L) / LDC (Linear)

Luminaire: Ledil CA10925 STRADA-B_(XM-L)
Lamps: 1 x Cree_XM-L_(XMLAWT-00-0000-0000T6051)
_102.237lm@250mA_CCT=8850K_P=0.7W_I=0.25A

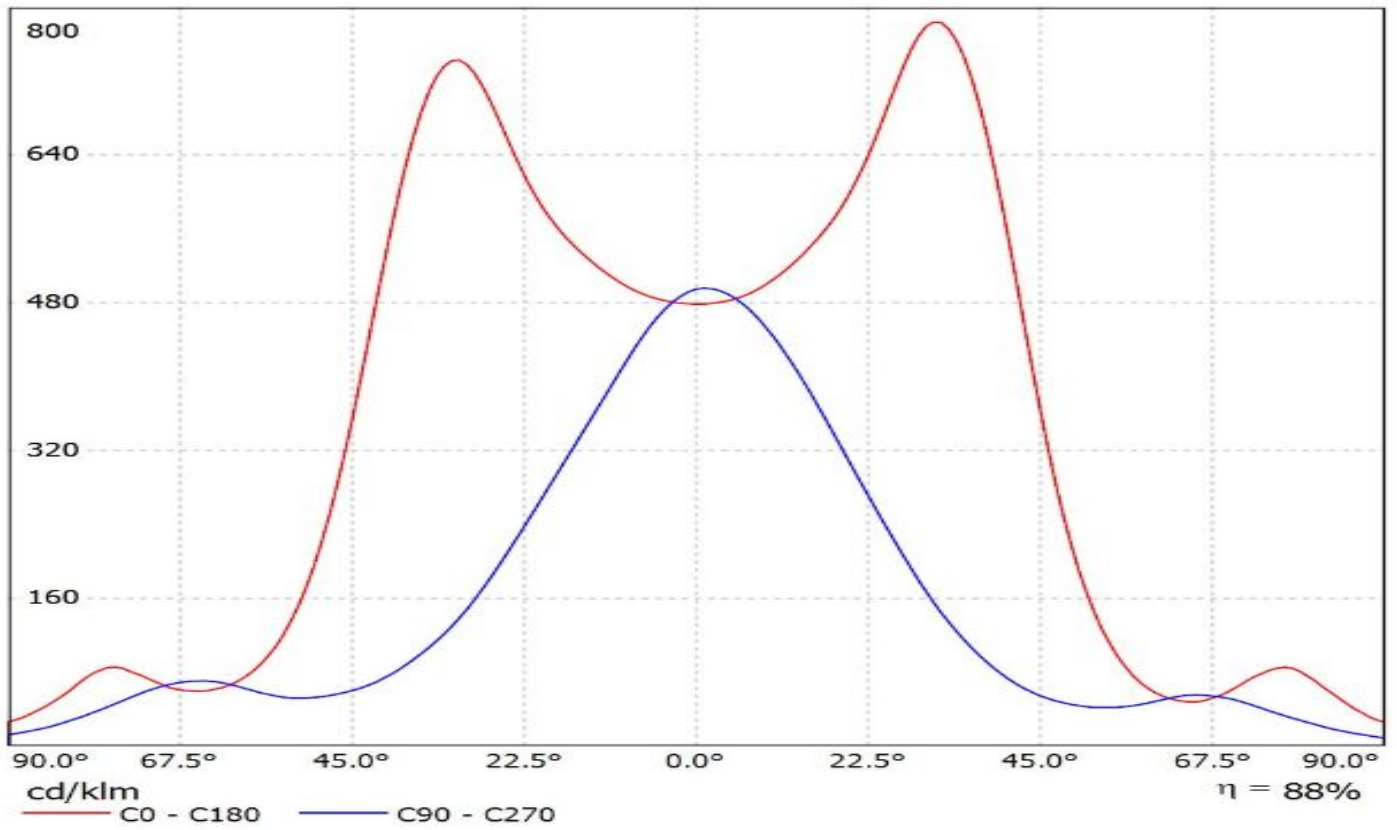

Ledil Oy C10924_Strada-B-XR C10924_Strada-B-XR / LDC (Polar)

Luminaire: Ledil Oy C10924_Strada-B-XR C10924_Strada-B-XR
Lamps: 1 x Cree XR-E (white)

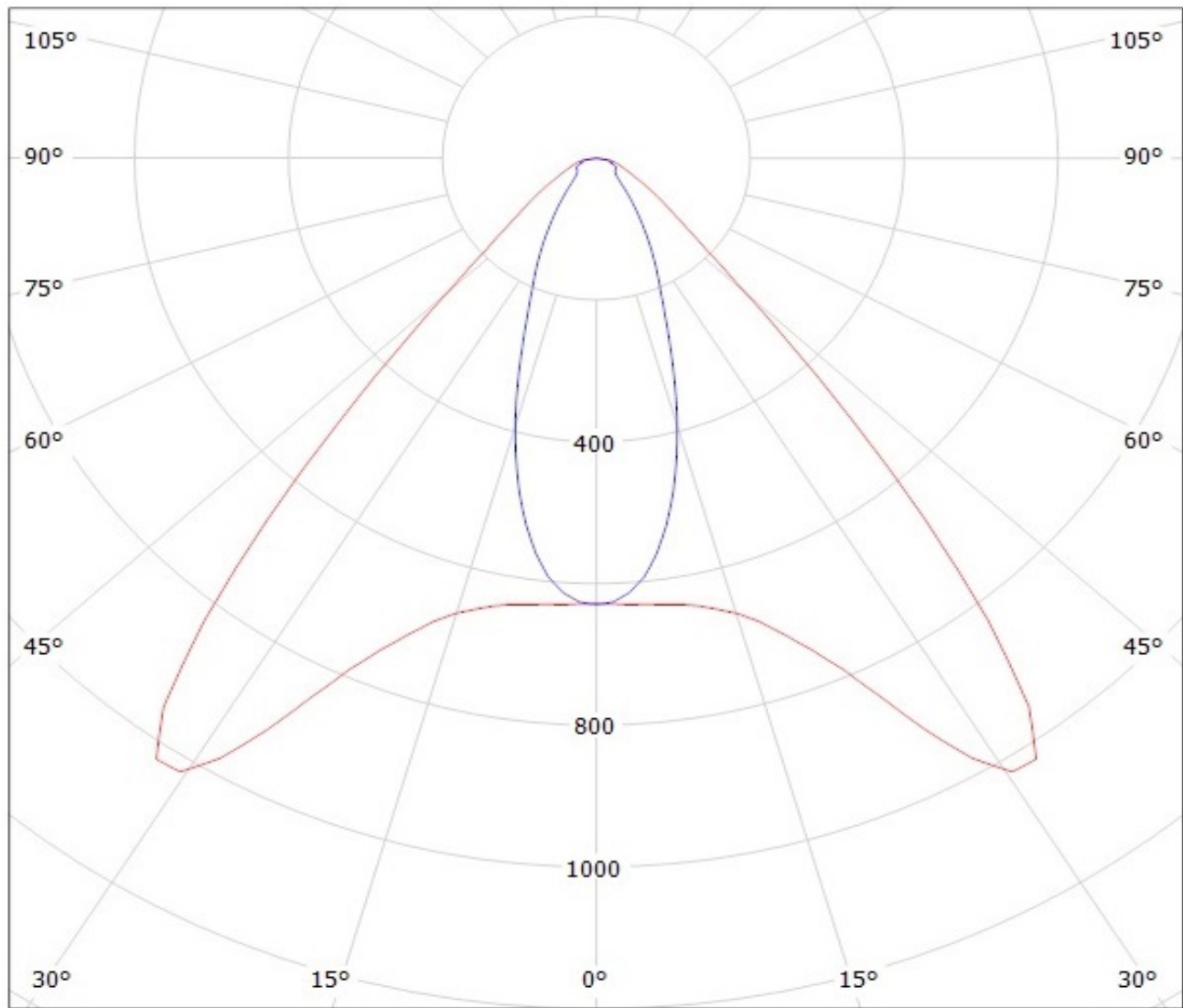

cd/klm

— C0 - C180

— C90 - C270

SIMULATED

Ledil CA10925 STRADA-B_(XM-L) / LDC (Polar)

Luminaire: Ledil CA10925 STRADA-B_(XM-L)
Lamps: 1 x Cree_XM-L_(XMLAWT-00-0000-0000T6051)
_102.237lm@250mA_CCT=8850K_P=0.7W_I=0.25A

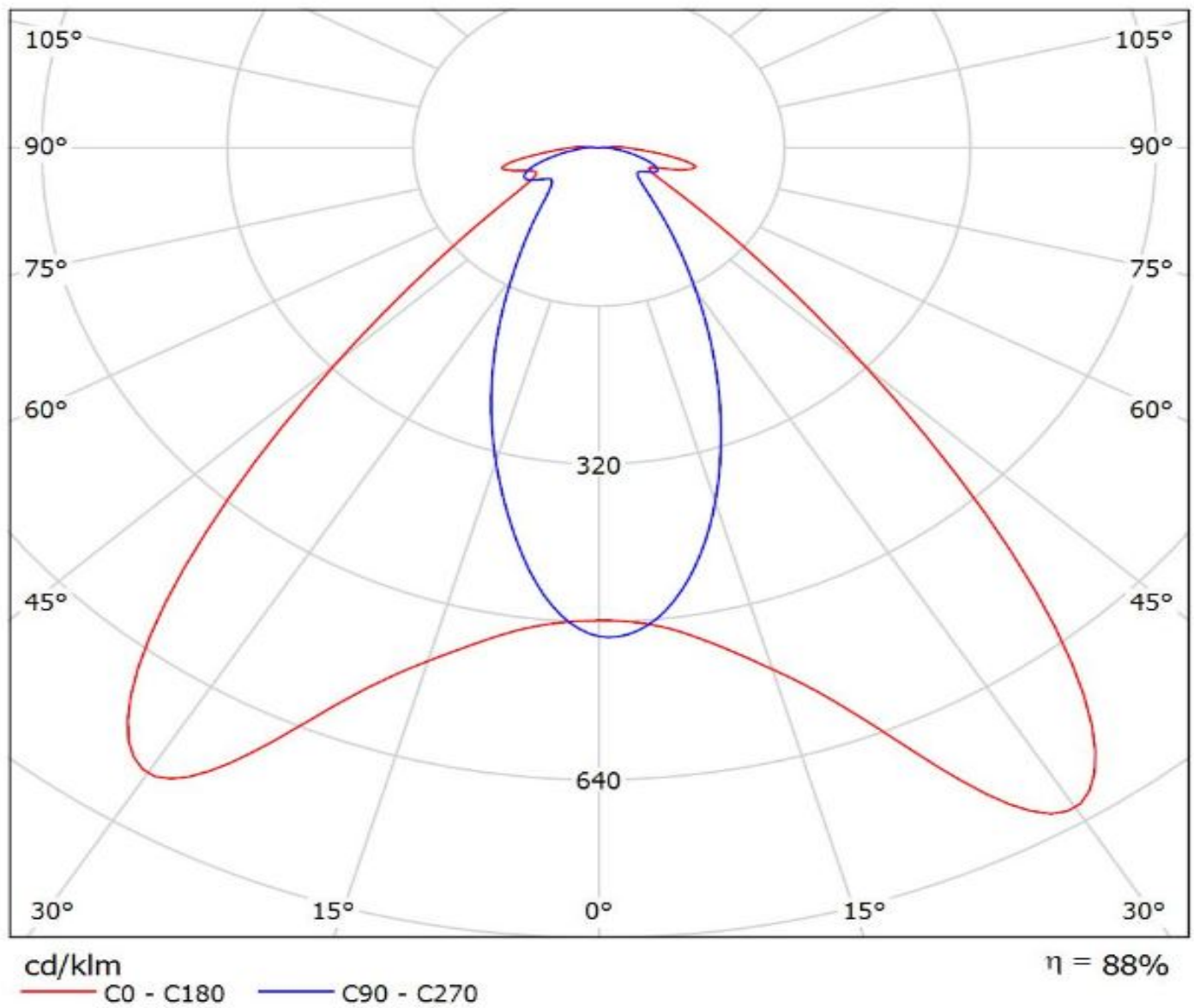

NOTE: The typical divergence will be changed by different color, chip size and chip position tolerance. The typical total divergence is the full angle measured where the luminous intensity is half of the peak value.