

Data Sheet

LL01ZZ-EXxxL06-M2-T

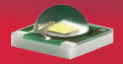

Xlamp XP-E

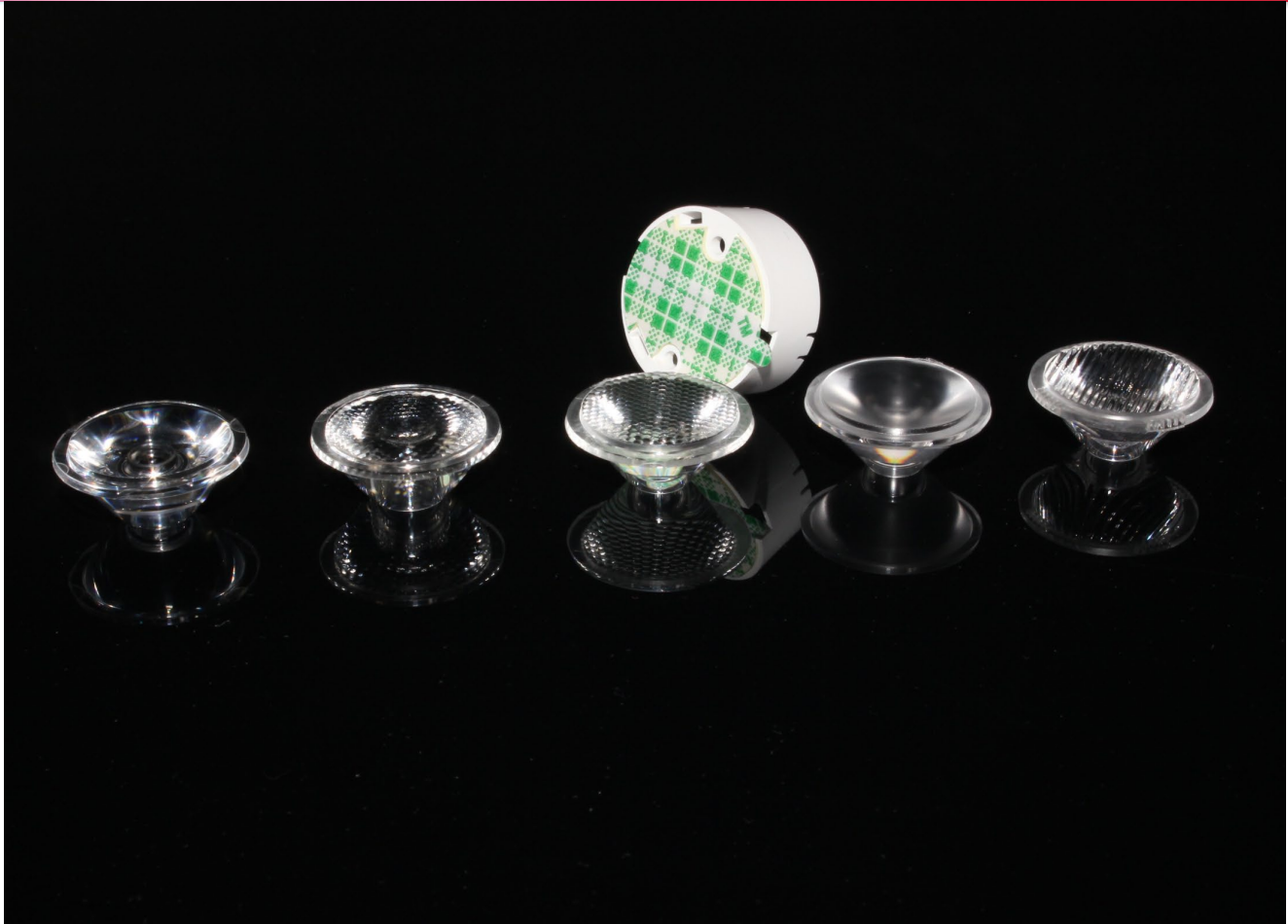

■ Features & Typical Applications

- High efficiency
- Available in 5 beam Patterns
- Optimized for uniform effects
- Lens with Housing
- Spot Lighting
- Architectural Lighting

■ Table of Contents

General Information & Product Nomenclature.....	P.2
Optical Specifications	P.3
Mechanical Specifications	P.4
Package Specifications	P.5

LL01ZZ-EXxxL06-Mx-T

General Information

- Lens Material Optical Grade PMMA
- Operating Temperature range -40°C~+70°C(upper limit +80°C)
- Storage Temperature range -40°C~+70°C(upper limit +80°C)
 - * Average transmittance in visible spectrum 400nm~700nm>90%
- Usage and Maintenance:
 1. If necessary, clean lenses with mild soap, water and soft cloth.
 2. Never use any commercial cleaning solvents on lenses, like alcohol.
 3. Please handle or install lenses with wearing gloves, skin oils may damage lens or its optical characteristic.

Product Nomenclature

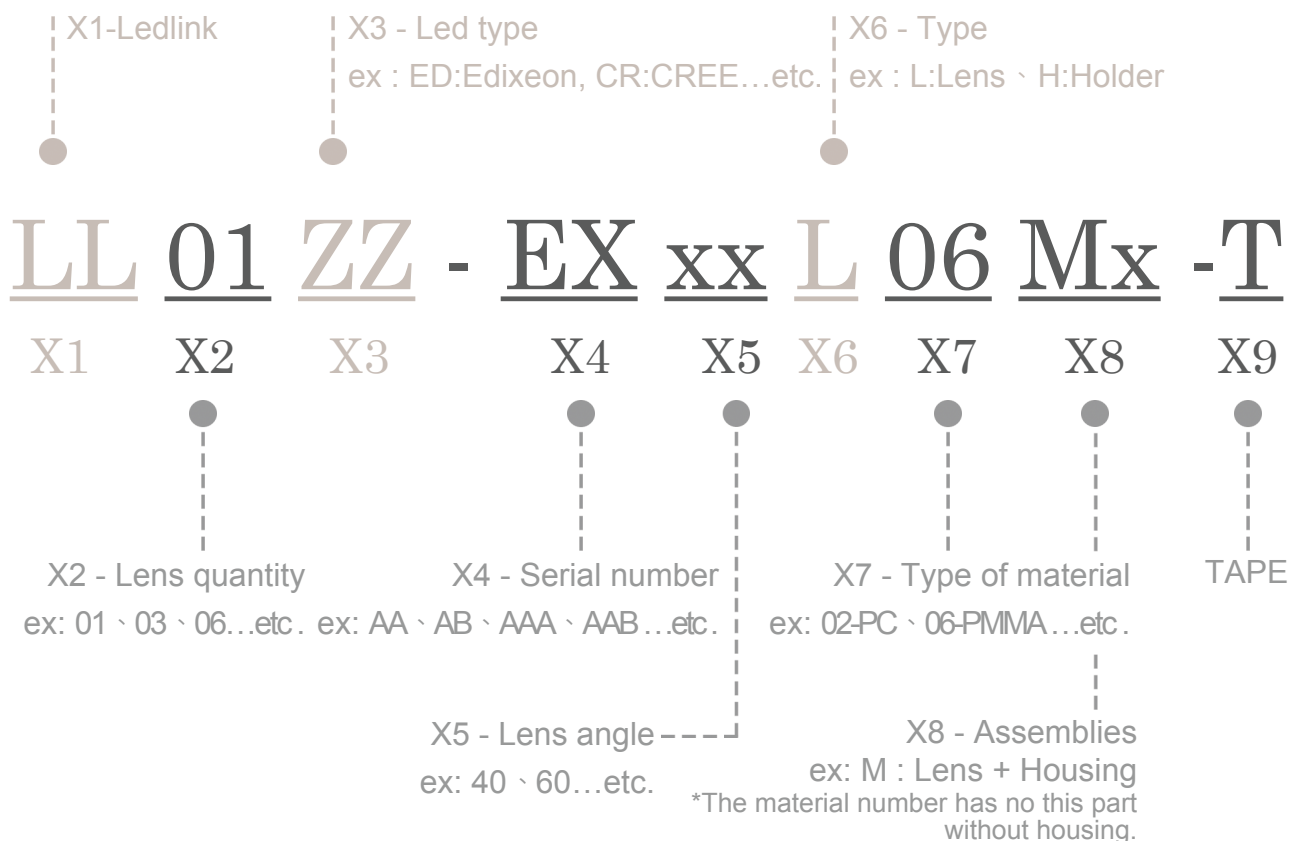





LL01ZZ-EXxxL06-M2-T

Optical Specifications

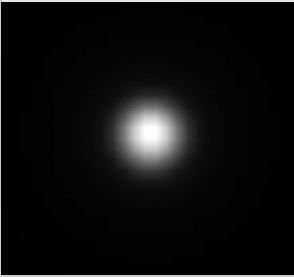
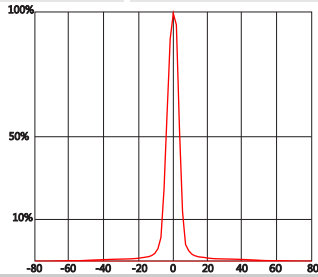
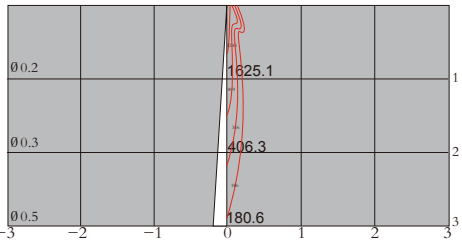

Xlamp XP-E

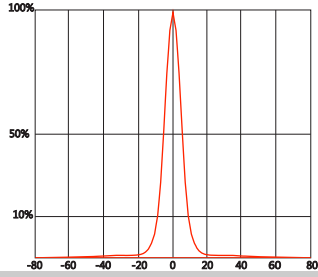
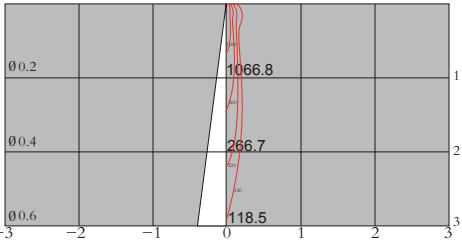
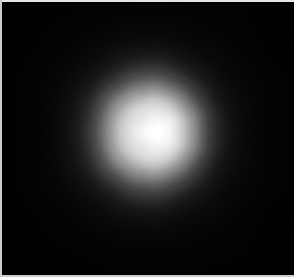
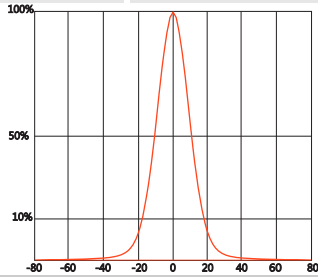
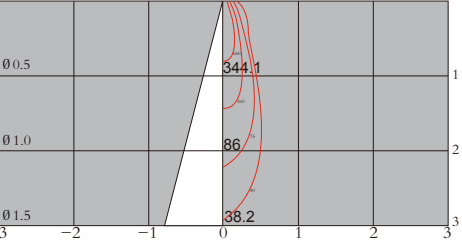
Note: (1) All the results of analysis are based on 0 degrees of elevation.
 (2) Tolerance: $\pm 10\%$.
 (3) Led Luminous Flux(lm): 100($\pm 5\%$).

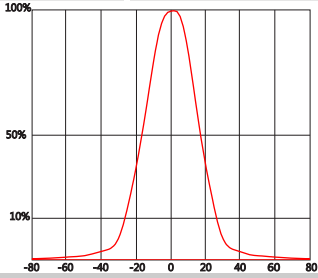
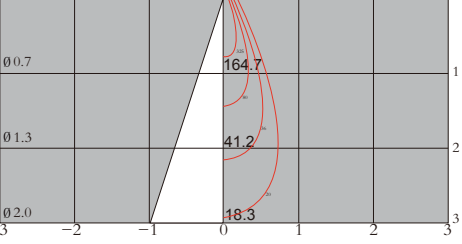
Part Number	FWHM	Field Angle*	cd / lm	IES File
LL01ZZ-EX10L06-M2-T	9°	16°	16.3	Download
				
Beam Pattern	Light Distribution Curve	Illuminance Distribution		
LL01ZZ-EX25L06-M2-T	12°	24°	10.7	Download
				
Beam Pattern	Light Distribution Curve	Illuminance Distribution		
LL01ZZ-EX40L06-M2-T	24°	47°	3.6	Download
				
Beam Pattern	Light Distribution Curve	Illuminance Distribution		
LL01ZZ-EX60L06-M2-T	38°	66°	1.6	Download
				
Beam Pattern	Light Distribution Curve	Illuminance Distribution		

LL01ZZ-EXxxL06-M2-T

Optical Specifications



Xlamp XP-E

Note: (1) All the results of analysis are based on 0 degrees of elevation.
 (2) Tolerance: $\pm 10\%$.
 (3) Led Luminous Flux(I_m): 100($\pm 5\%$).

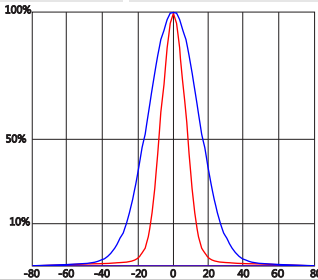
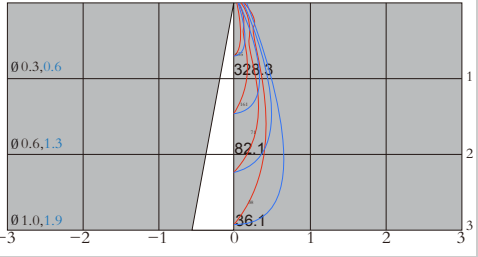
Part Number	FWHM	Field Angle*	cd / lm	IES File
LL01ZZ-EX3065L06-M2-T	19°/38°	33°/70°	3.3	Download
				
Beam Pattern	Light Distribution Curve	Illuminance Distribution		

*The Field Angle is the angle between the two directions opposed to each other over the beam axis for which the luminous intensity is 10% that of the maximum luminous intensity.
 *This testing result is obtained through testing the popular rank LED samples which provided by the original manufacturer. Hence, the testing results would be varied as the users choose same LED model but different rank.

LL01ZZ-EXxxL06-M2-T

Mechanical Specification

1. Fixing method

 Glue

 Screw

 Tape

 Fixing-ring

 Frame

Note: (1) All dimensions are in mm.
 (2) All measurements are ± 0.15 mm unless otherwise indicated.

2. Lens dimensions

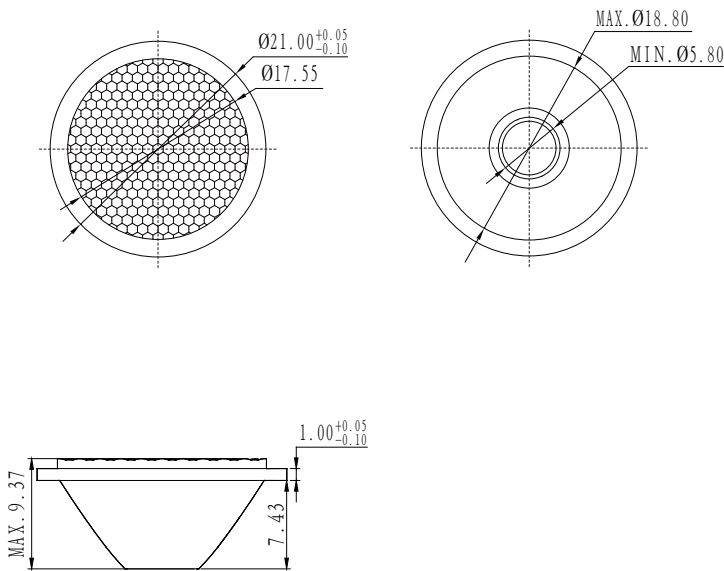

3. Lens + Leds + MCPCB assembly instruction

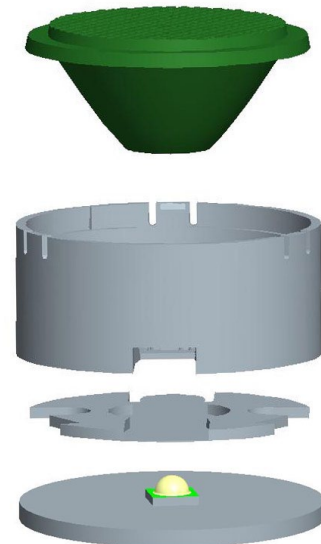

4. Lens assembly dimensions

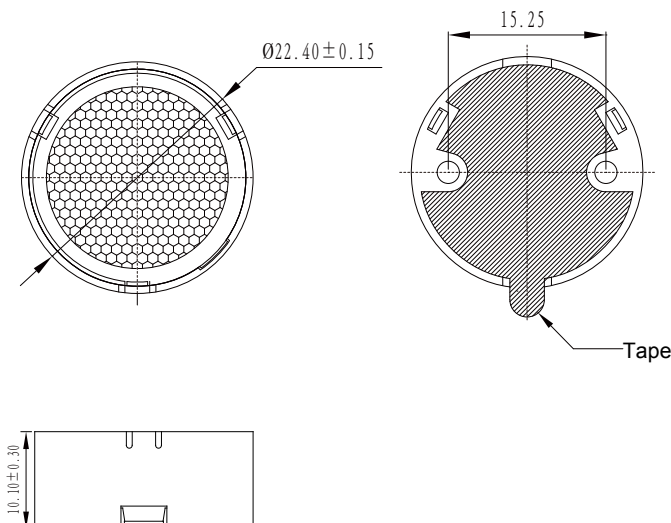

5. View assembly lens with MCPCB:

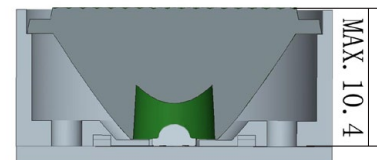

LL01ZZ-EXxxL06-M2-T

Package Specifications

Item	Quantity	Total	Size(L*W*H)	G.W
Inner box		100 pcs	33.5*30*1.8 cm	1.4g
Outer box	1000 pcs/Outer box	1000 pcs	35*31*21 cm	

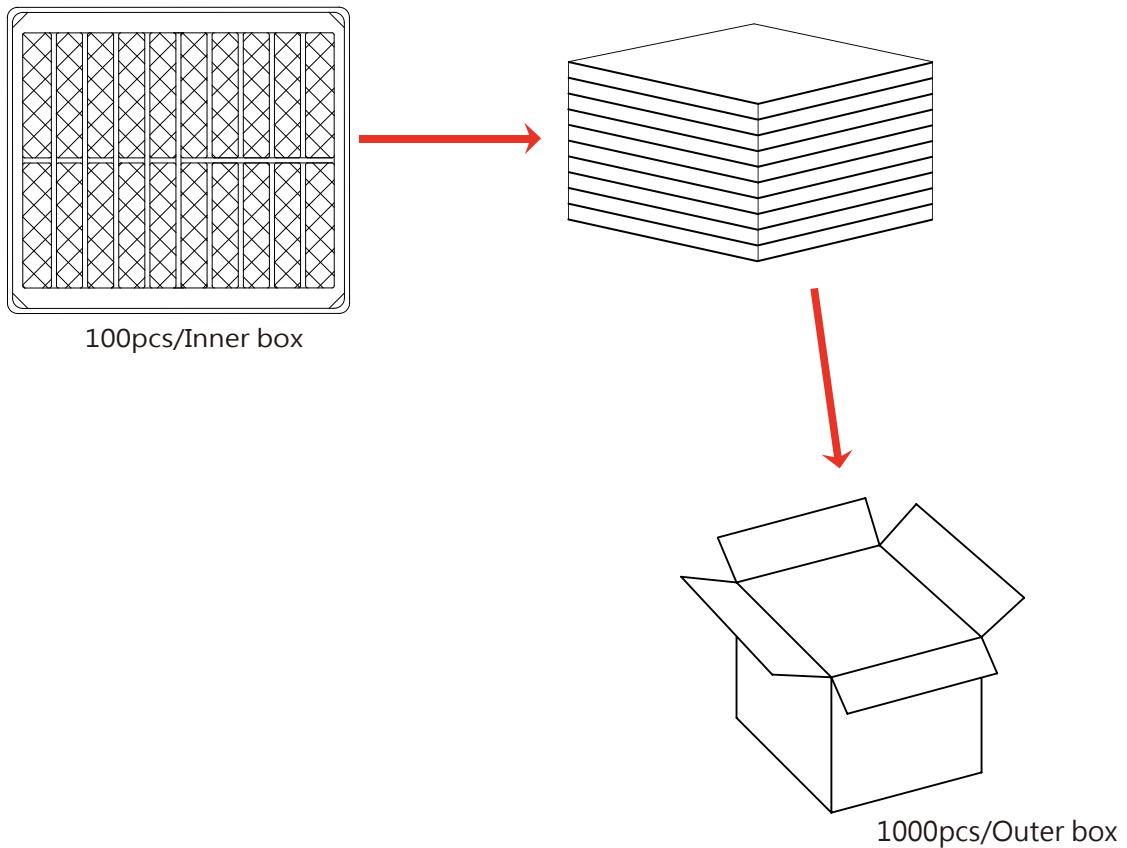

Note: