

DETAILS

Product Number	C12410_STRADA-SQ-A-T
Family	Strada-SQ
Type	Lens
Color	clear
Diameter	25 + 25 mm
Height	9 mm
Style	square
Optic Material	PMMA
Holder Material	
Fastening	screw, glue
Status	production ready
ROHS Compliant	Yes
Date Updated	24/04/2014

OPTICAL PROPERTIES

LED	Viewing Angle	Light Beam	Efficiency	cd/lm	Connector
XM-L	Asymmetric deg	Streetligh...	93 %	-	-
XM-L2	asymmetric deg	Streetligh...	94 %	0.700	-
XHP50	Asymmetric deg	Streetligh...	94 %	0.570	-
LUXEON M/MX	Asymmetric deg	Streetligh...	93 %	-	-
LUXEON MZ	asymmetric deg	Streetligh...	93 %	0.730	-
NFMW48xA	Asymmetric deg	Streetligh...	94 %	0.610	-
Oslon Square PC	Asymmetric deg	Streetligh...	96 %	sim: 0.800	-



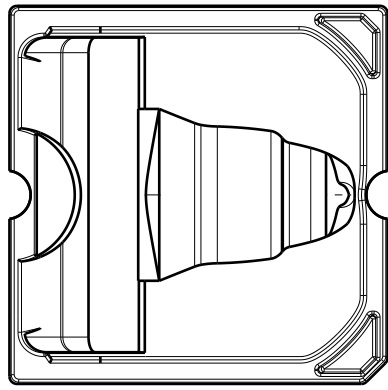

Bottom view

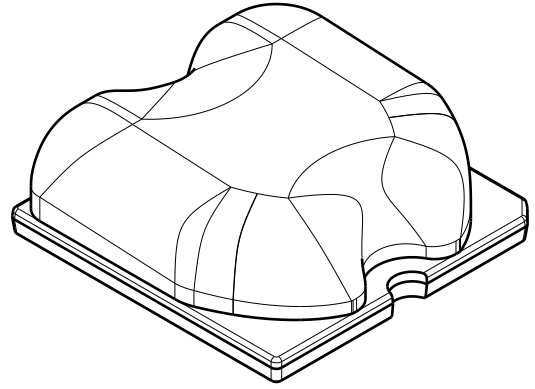

Isometric view

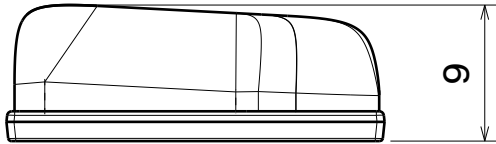

Front view

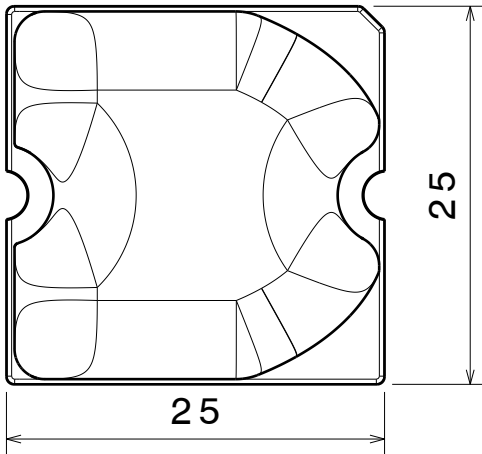

Top view

Tolerances if not otherwise shown:
According to DIN ISO 2768-1
Linear measures:
Up to 30mm class M, otherwise class C.

According to DIN ISO 2768-2
Form and position:
class L

Control for SPC marked dimensions.

This drawing is our property.
It can't be reproduced
or communicated without
our written agreement.

LEDiL Ledil Oy
Salorankatu 10
FIN 24240 SALO
Finland

DRAWING TITLE Mechanical drawing

DRAWN BY
as

DATE
25.9.2012

STRADA-SQ-A-T

CHECKED BY
VS

DATE
-

SIZE A4

PART NUMBER

REV
001

DESIGNED BY
-

DATE
-

SCALE 2:1 WEIGHT 4,97 g SHEET 1/1

Luminaire: Ledil Oy C12410_STRADA-SQ-A-T-XM-L Efficiency=88%
Lamps: 1 x Cree XM-L 95lm @ 250mA

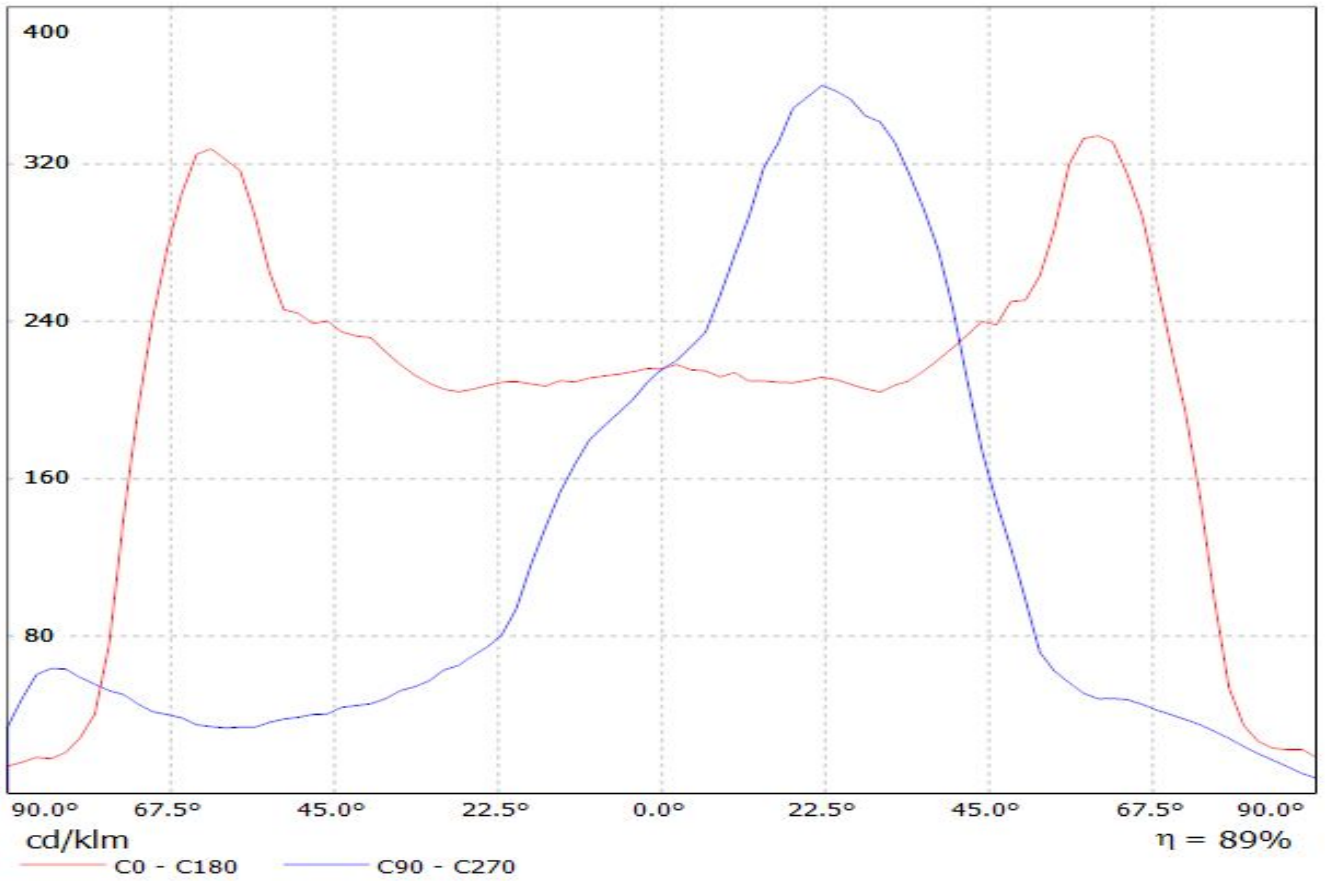

Luminaire: LEDil Oy C12410_STRADA-SQ-A-T_(XM-L2) Efficiency=94%
Lamps: 1 x Cree XM-L2 (XMLBWT-0-7B4-T30-0L-0001) 91lm @ 250mA CCT=3200K P=2.8W I=250mA

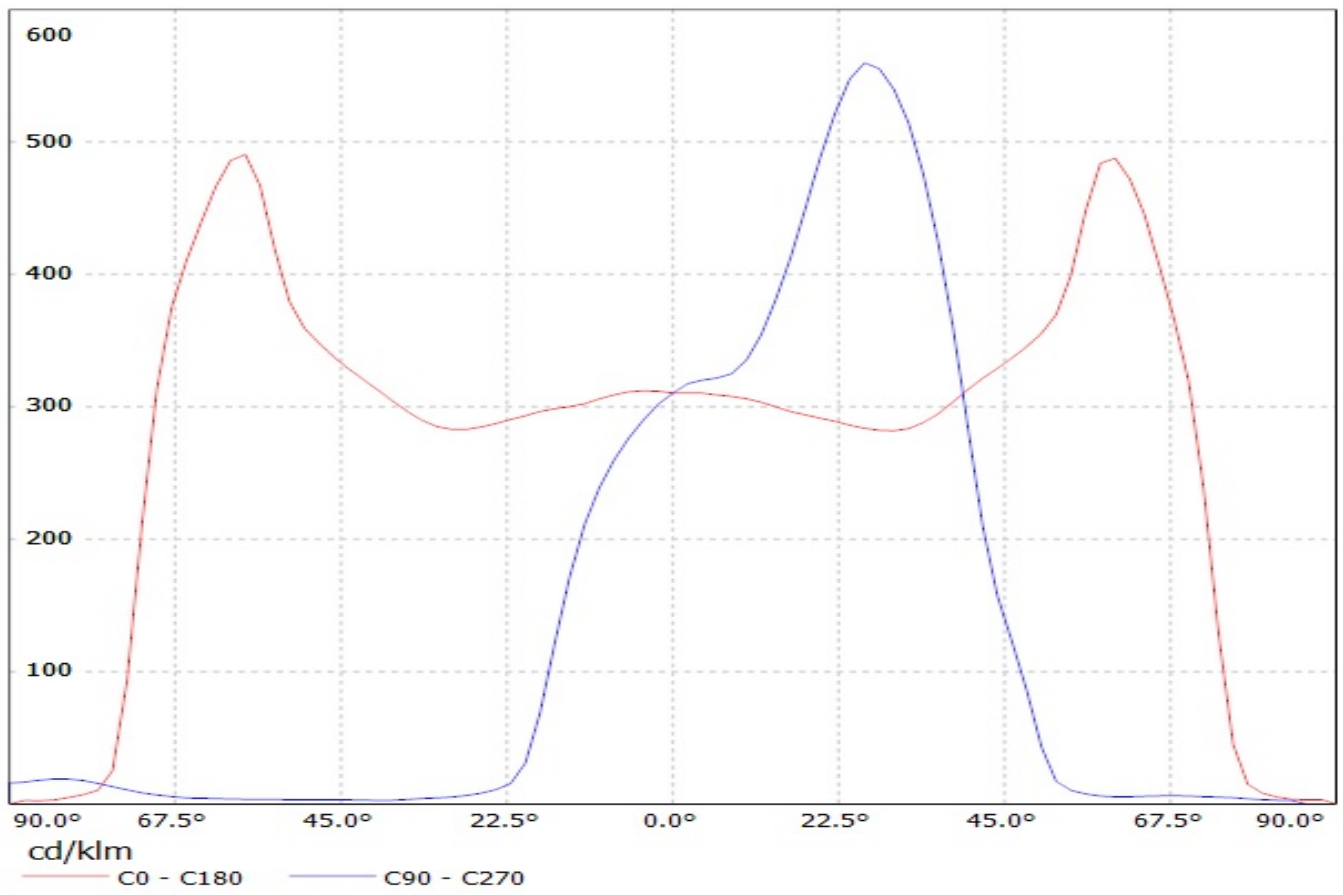

Luminaire: LEDiL Oy C12410_STRADA-SQ-A-T_(XHP50_cool_white)
Lamps: 1 x XHP50_cool_white_243.744lm@250mA_P=1.42945W_I=0.2499A

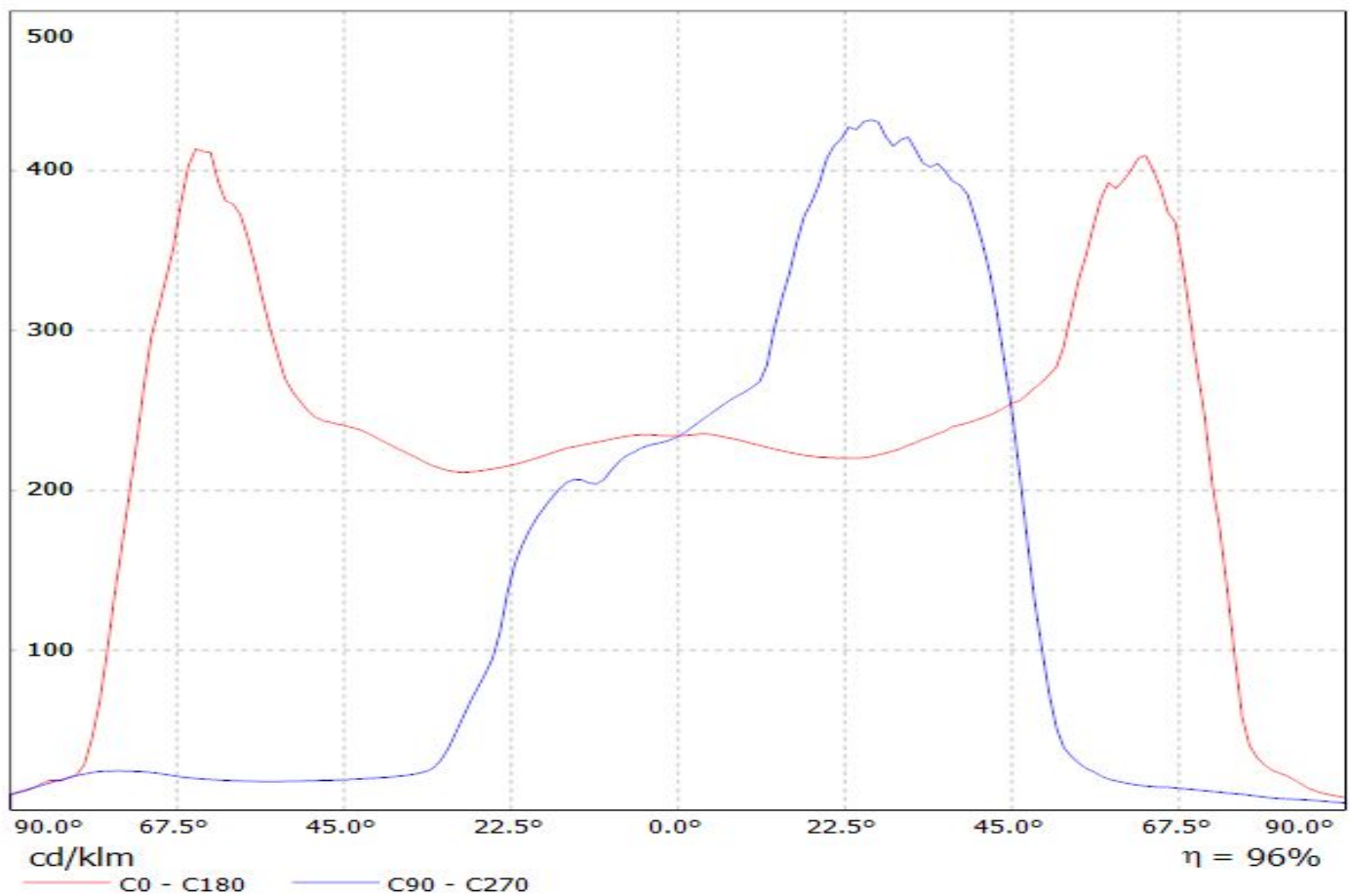

Luminaire: LEDiL Oy C12410_STRADA-SQ-A-T_(Luxeon_MZ) Eff. 93%
Lamps: 1 x LUXEON-MZ_263.325lm@250mA_P=2.7414W_I=249.9mA

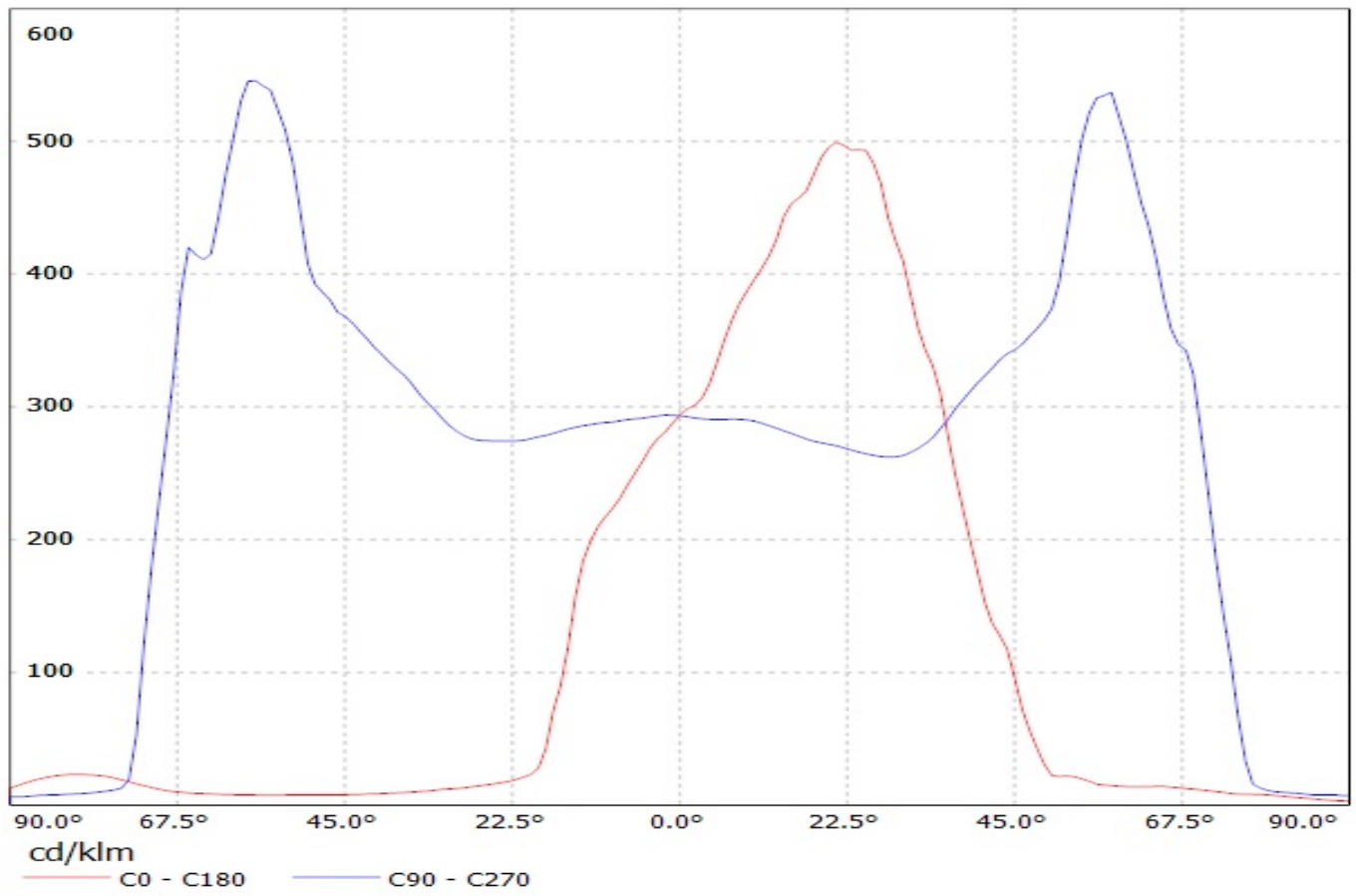

Luminaire: LEDiL Oy C12410_STRADA-SQ-A-T_(NFMx48xAR)
Lamps: 1 x Nichia_NFMx48xAR_(NFMW488AR)_574.333lm@100mA_P=4.0048W_I=0.100A

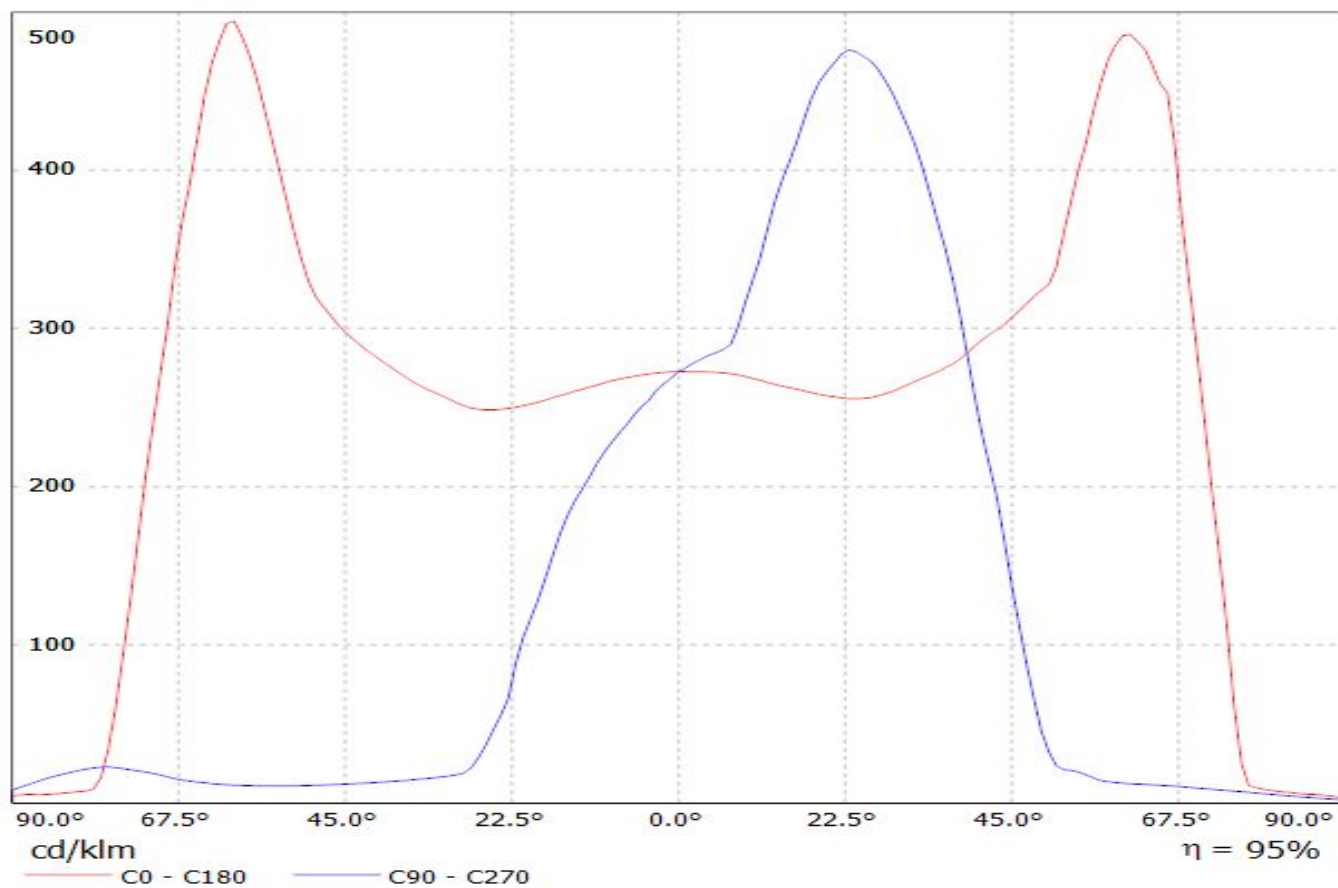

Luminaire: LEDIL OY C12410_STRADA-SQ-A-T_(Osram Square PC) Eff. 96%
Lamps: 1 x Osram Square PC (86.7lm@250mA)

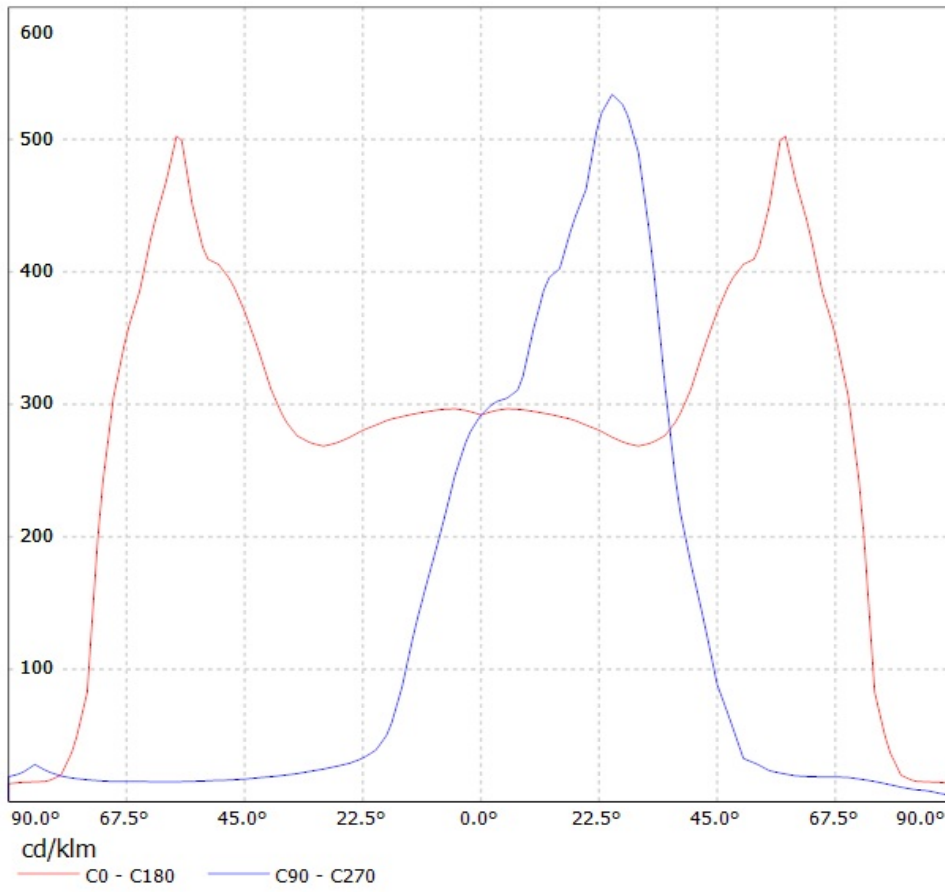

Luminaire: Ledil Oy C12410_STRADA-SQ-A-T-XM-L Efficiency=93%
Lamps: 1 x Cree XM-L 95lm @ 250mA

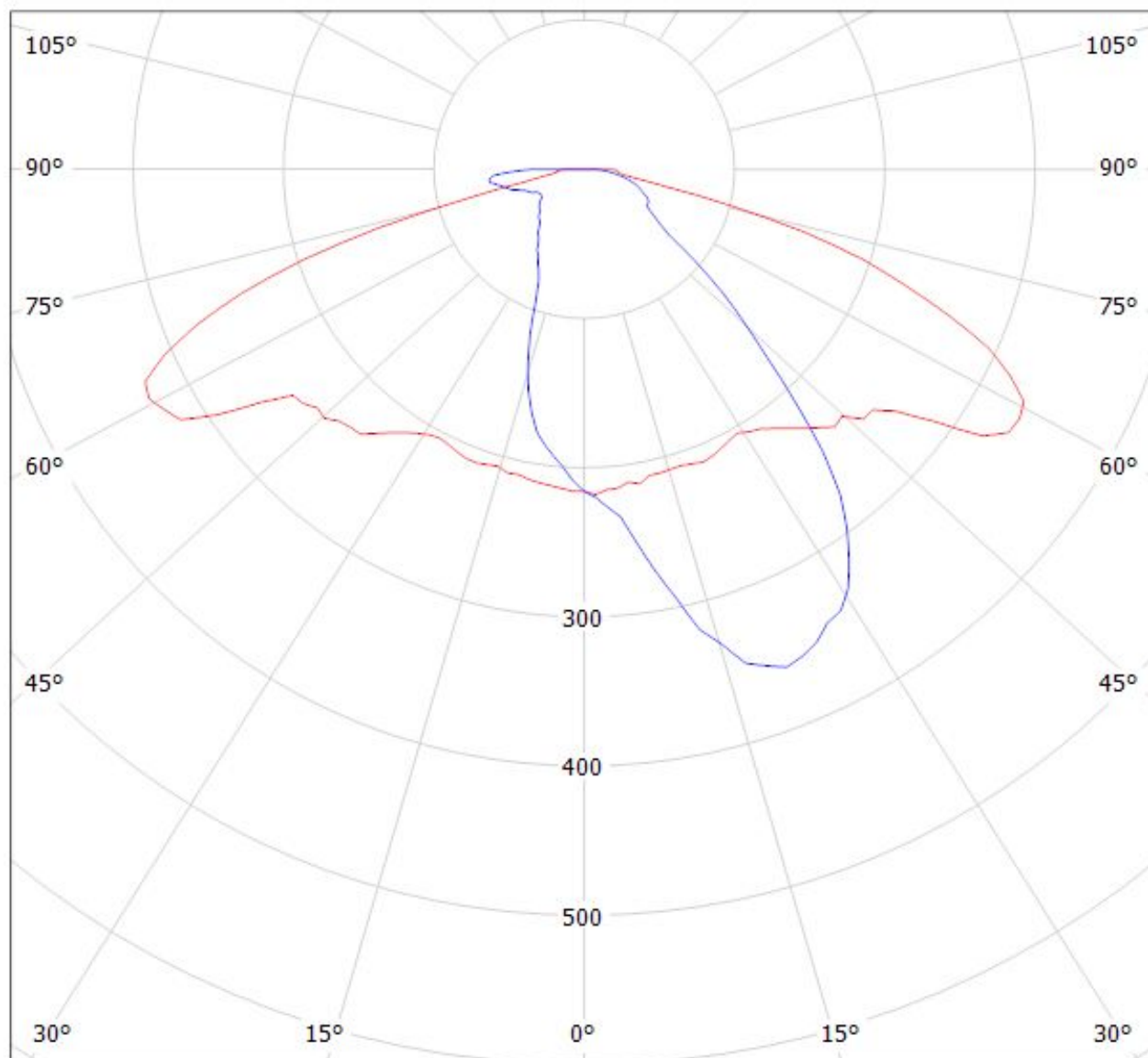

cd/klm

— C0 - C180

— C90 - C270

$\eta = 89\%$

Luminaire: LEDil Oy C12410_STRADA-SQ-A-T_(XM-L2) Efficiency=94%
Lamps: 1 x Cree XM-L2 (XMLBWT-0-7B4-T30-0L-0001) 91lm @ 250mA CCT=3200K P=2.8W I=250mA

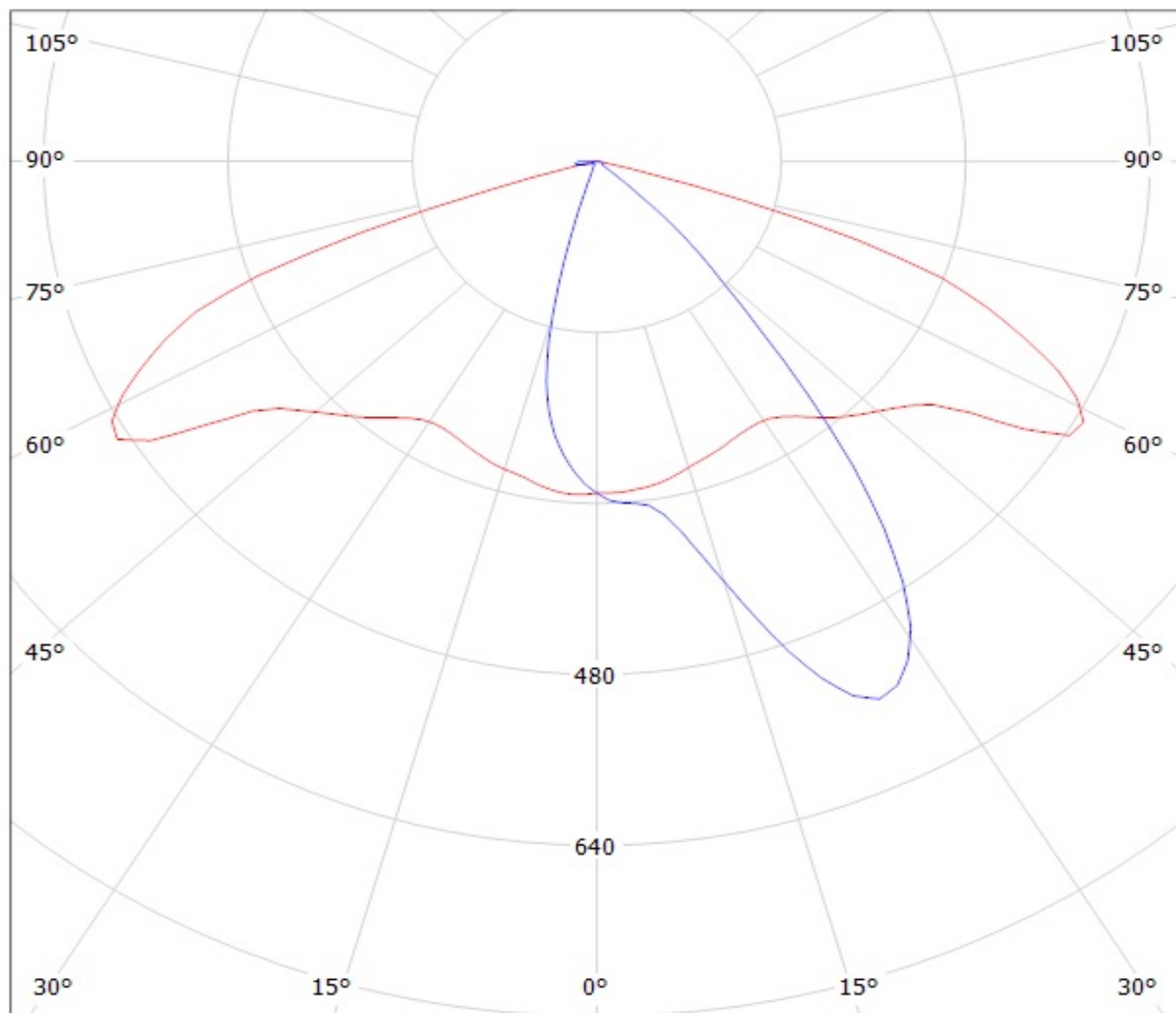

cd/klm
— C0 - C180 — C90 - C270

Luminaire: LEDiL Oy C12410_STRADA-SQ-A-T_(XHP50_cool_white)

Lamps: 1 x XHP50_cool_white_243.744lm@250mA_P=1.42945W_I=0.2499A

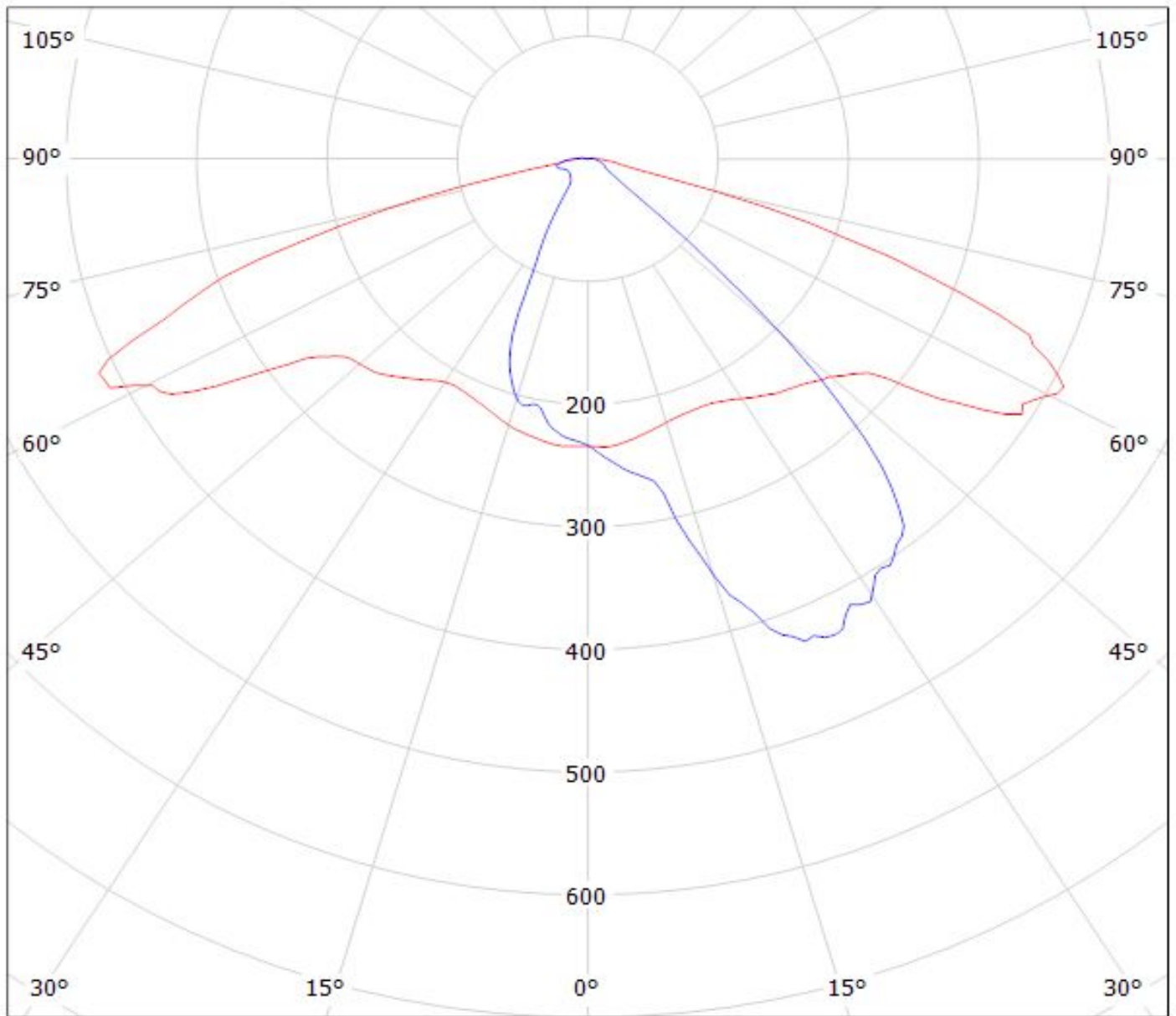

cd/klm

η = 96%

— C0 - C180

— C90 - C270

Luminaire: Ledil Oy C12410_STRADA-SQ-A-T (Luxeon M) Efficiency=93%
Lamps: 1 x Luxeon M 362lm @ 250mA

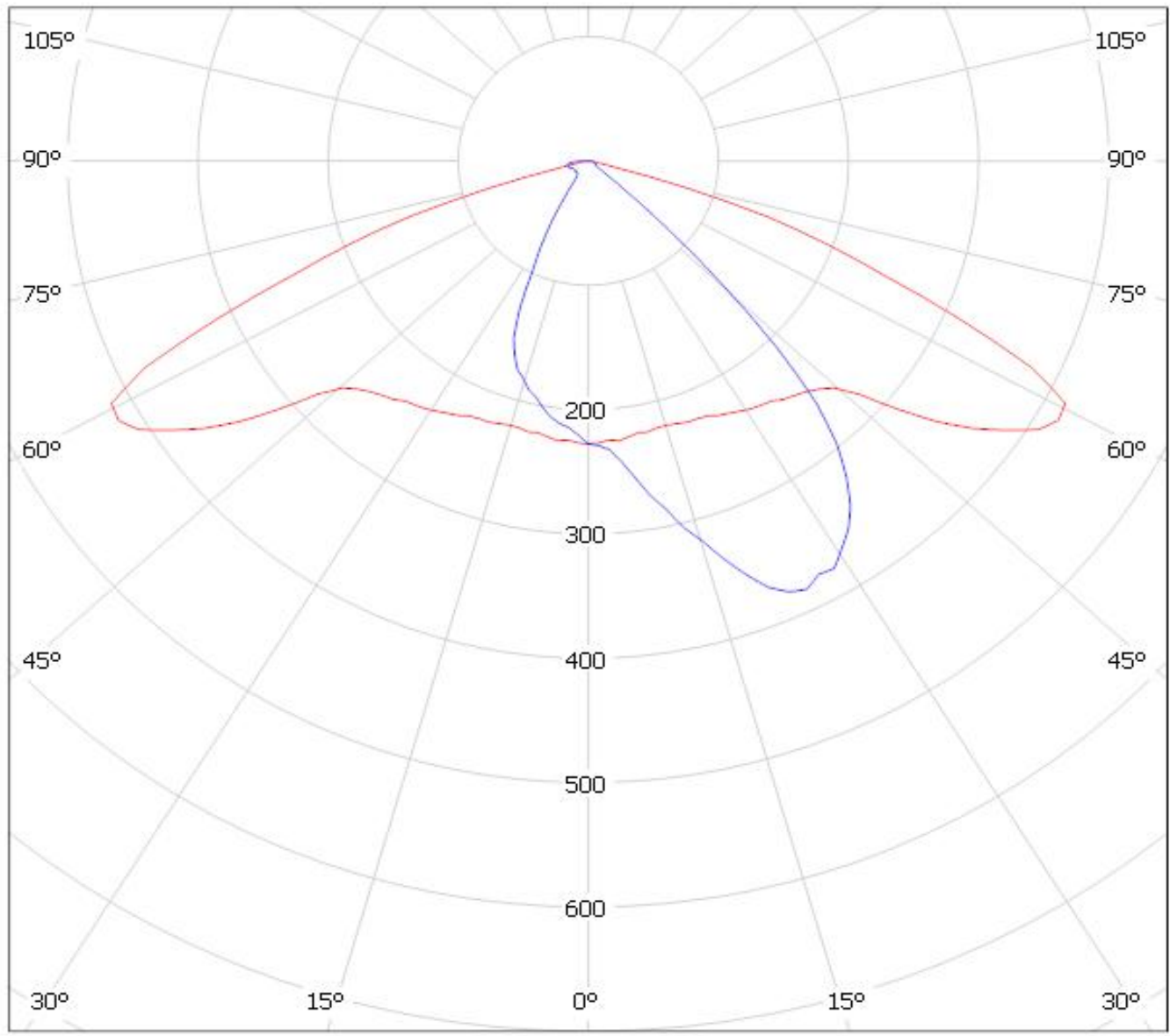

cd/klm
— C0 - C180 — C90 - C270

$\eta = 91\%$

Luminaire: LEDiL Oy C12410_STRADA-SQ-A-T_(Luxeon_MZ) Eff: 93%
Lamps: 1 x LUXEON-MZ_263.325lm@250mA_P=2.7414W_I=249.9mA

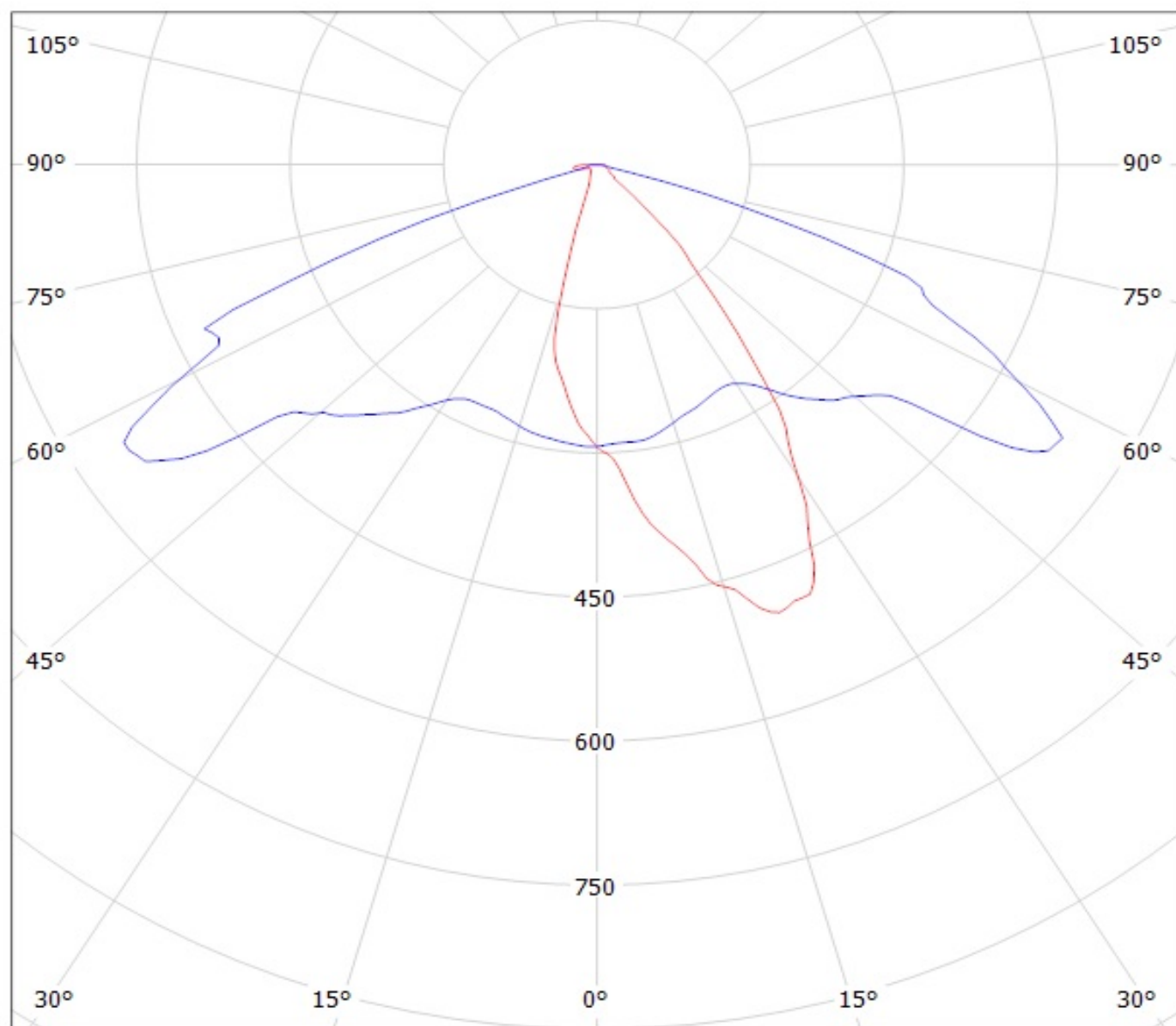

cd/klm

— C0 - C180 — C90 - C270

Luminaire: LEDiL Oy C12410_STRADA-SQ-A-T_(NFMx48xAR)

Lamps: 1 x Nichia_NFMx48xAR_(NFMW488AR)_574.333lm@100mA_P=4.0048W_I=0.100A

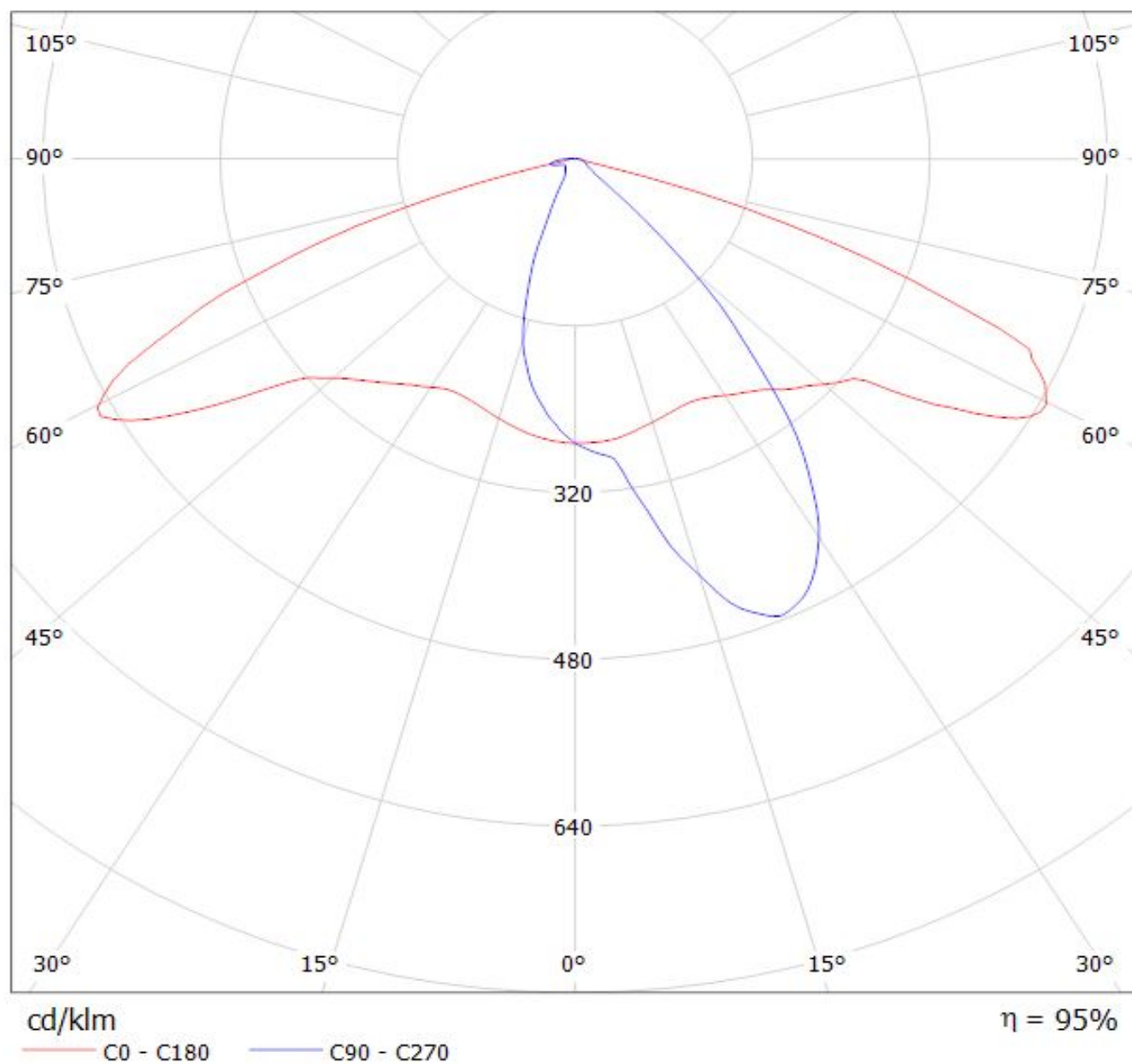

Luminaire: LEDIL OY C12410_STRADA-SQ-A-T_(Osram Square PC) Eff. 96%
Lamps: 1 x Osram Square PC (86.7lm@250mA)

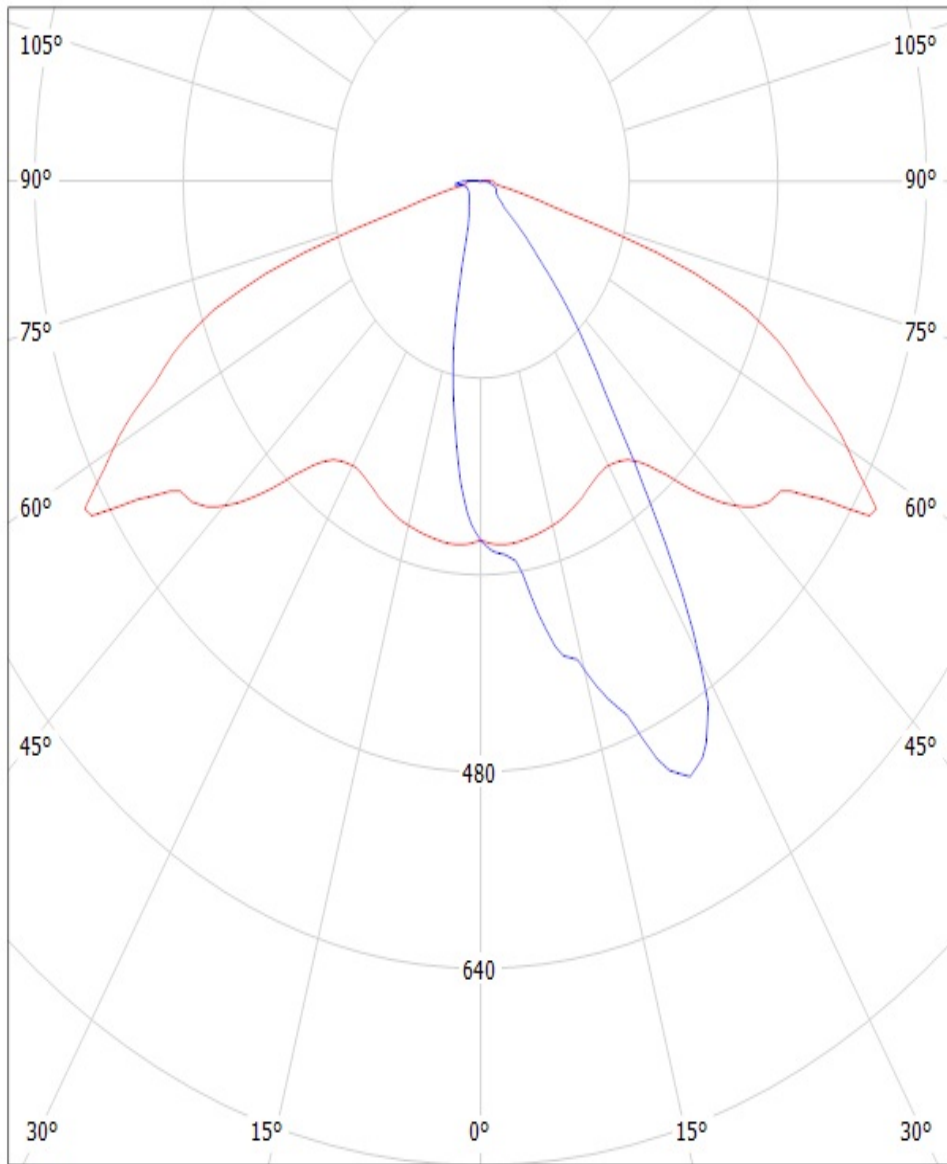

cd/klm

— C0 - C180 — C90 - C270

NOTE: The typical divergence will be changed by different color, chip size and chip position tolerance. The typical total divergence is the full angle measured where the luminous intensity is half of the peak value.