

## DETAILS

<b>Product Number</b>	CA10932_FLARE-B
<b>Family</b>	Flare
<b>Type</b>	Assembly
<b>Color</b>	clear
<b>Diameter</b>	29 x 22,8 mm
<b>Height</b>	12,84 mm
<b>Style</b>	rectang
<b>Optic Material</b>	PMMA
<b>Holder Material</b>	
<b>Fastening</b>	screw, tape
<b>Status</b>	production ready
<b>ROHS Compliant</b>	Yes
<b>Date Updated</b>	20/05/2016



## OPTICAL PROPERTIES

LED	Viewing Angle	Light Beam	Efficiency	cd/lm	Connector
XP-E	102+10 deg	REC-class	93 %	1.750	-
XP-G	118+15 deg	REC-class	93 %	1.000	-
XB-D	10+108 deg	REC-class	93 %	1.520	-
XP-E2	11+101 deg	REC-class	94 %	2.300	-
LUXEON Rebel	101+14 deg	REC-class	93 %	1.700	-
LUXEON Rebel ES	12+104 deg	REC-class	94 %	1.370	-
LUXEON T	13+105 deg	REC-class	93 %	1.500	-
LUXEON H50-2	sim: 13+90	REC-class	sim: 95 %	sim: 2.100	-
LUXEON TX	14+114 deg	REC-class	93 %	1.600	-
NCSxx19A	9+88 deg	REC-class	94 %	2.040	-
NCSxx19B	11+103 deg	REC-class	94 %	1.850	-
NVSxx19B/NVSxx19C	14+110 deg	REC-class	96 %	1.600	-
Oslon SSL 80	83+11 deg	REC-class	93 %	2.200	-
Oslon SSL 150	9+117 deg	REC-class	93 %	1.600	-
Oslon Square EC	12+104 deg	REC-class	-	-	-
Z5	12+96 deg	REC-class	-	-	-
Double Dome (GM2BB)	104+10 deg	REC-class	-	-	-

Relative intensity of CA10932\_FLARE-B\_(XP-E)

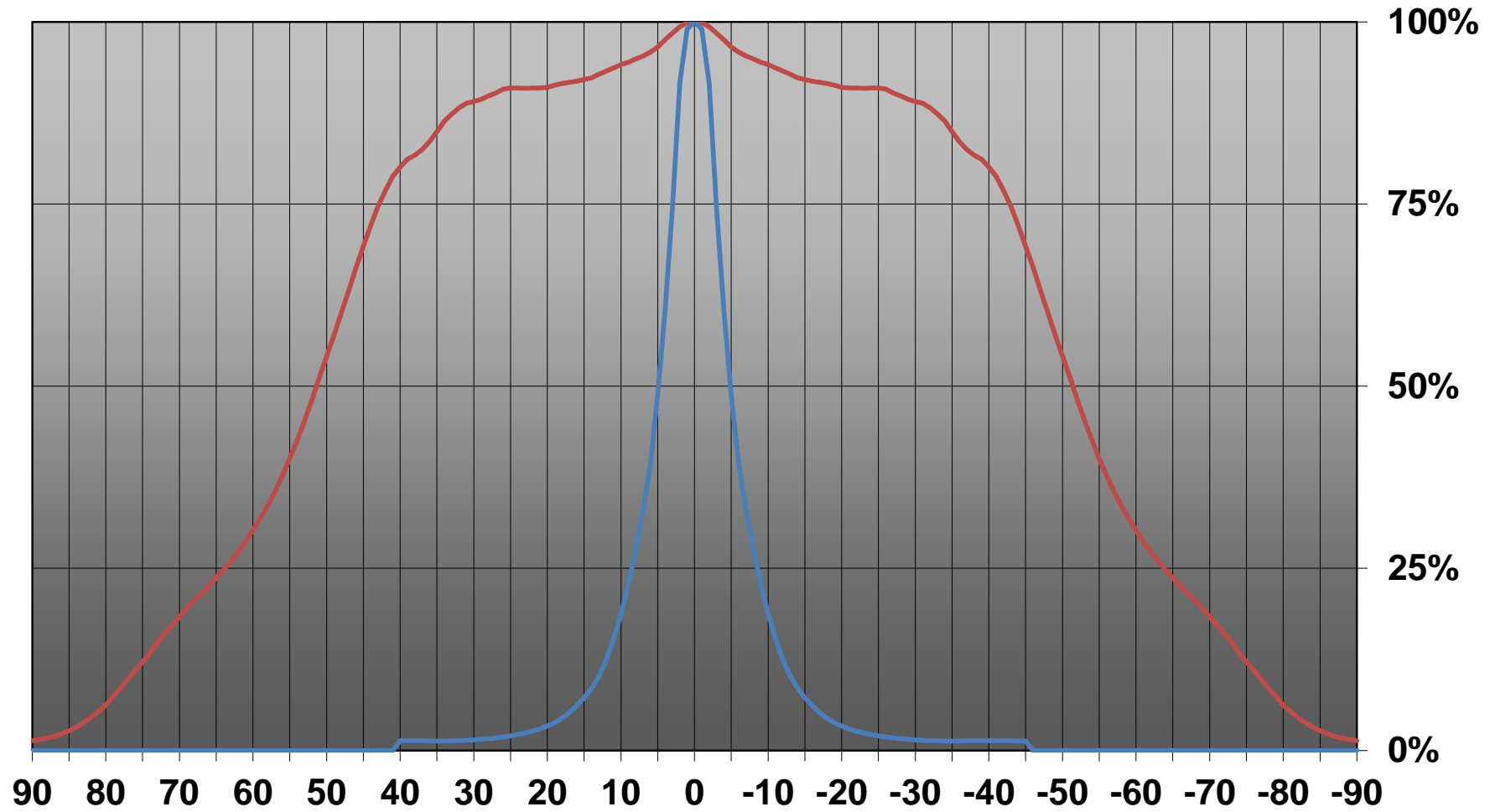

# Relative intensity of CA10932\_FLARE-B\_(NCSxx19A)

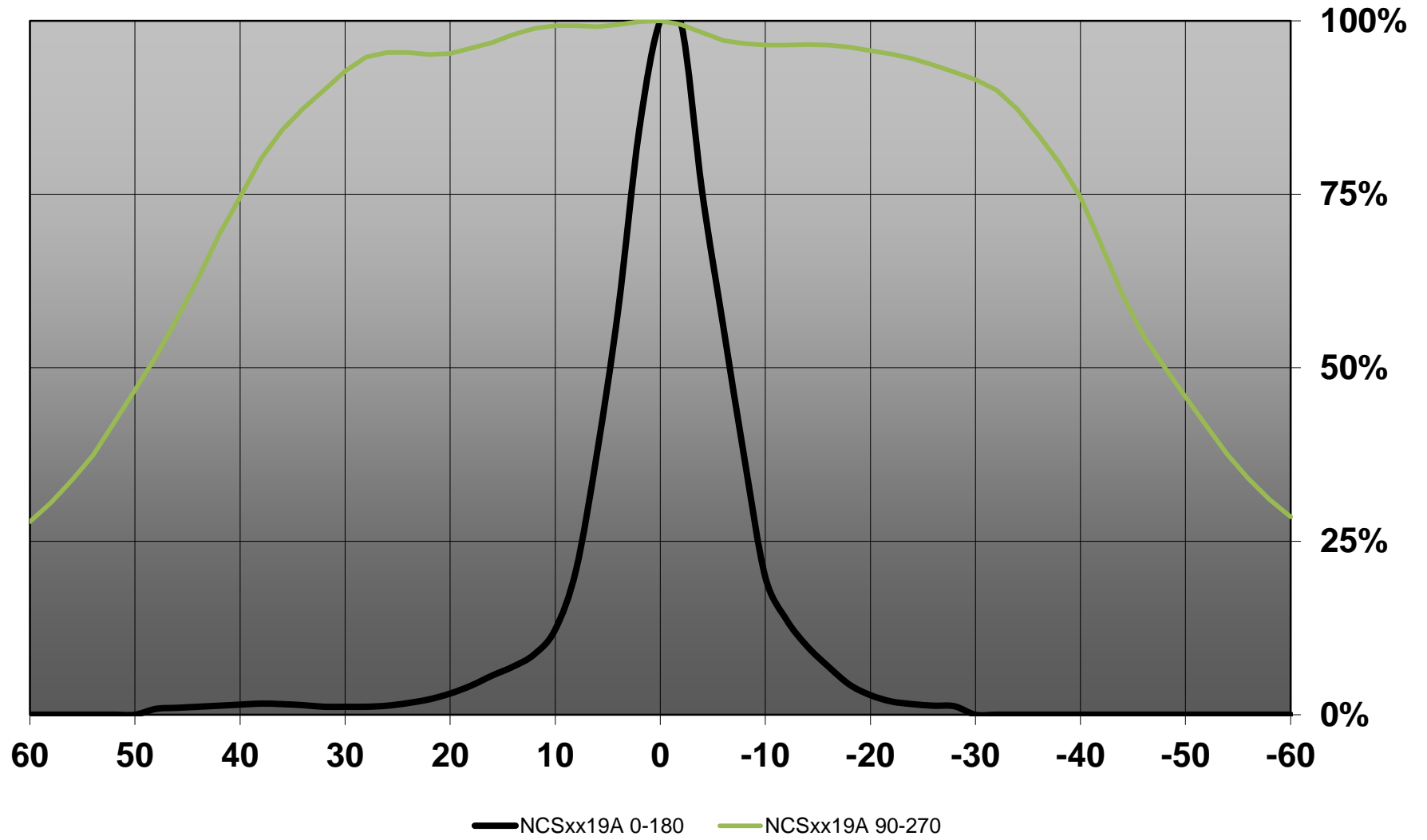

# Relative intensity of CA10932\_FLARE-B\_(NCSxx19B)

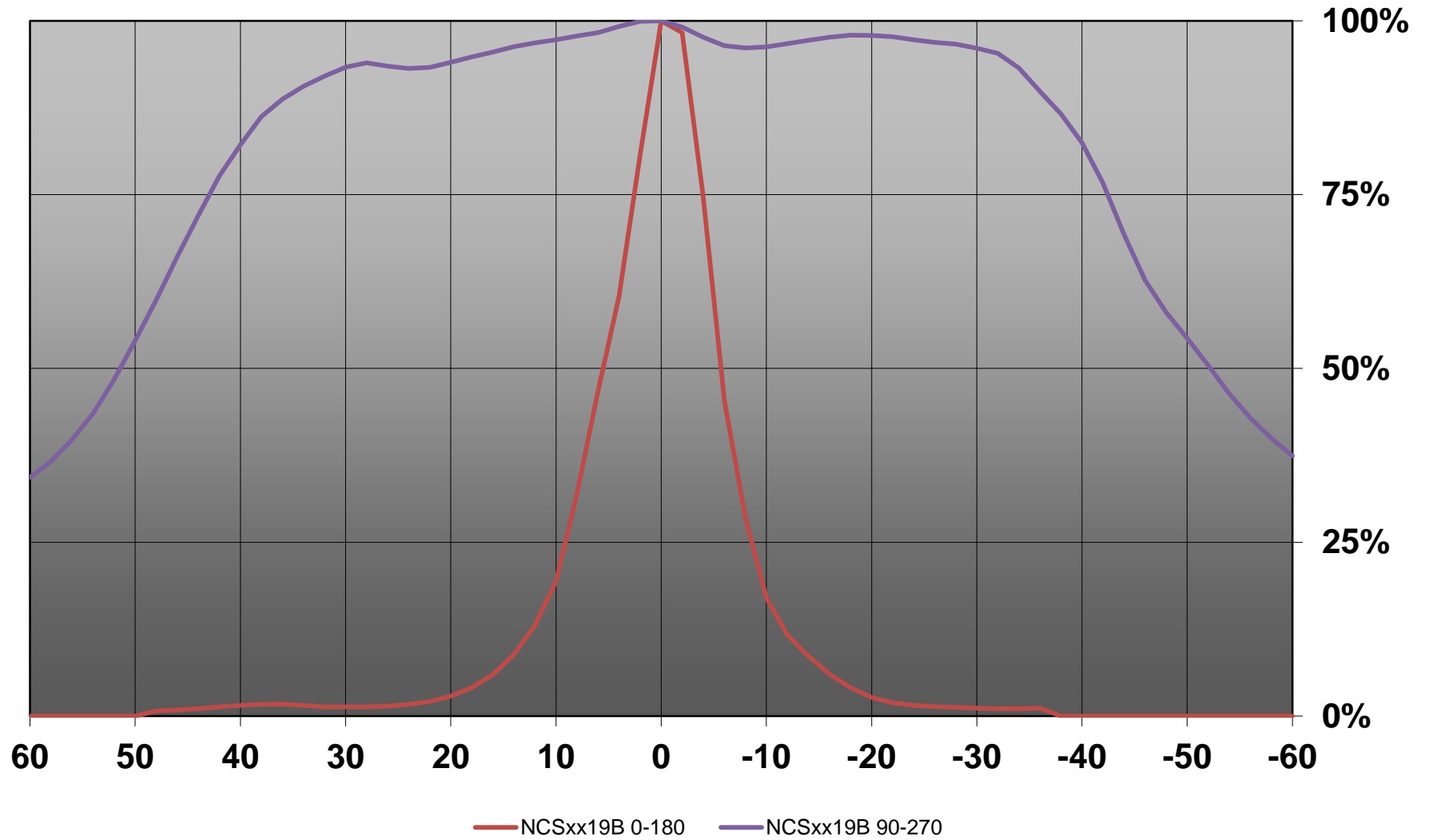

Relative intensity of CA10932\_FLARE-B (OSL150)

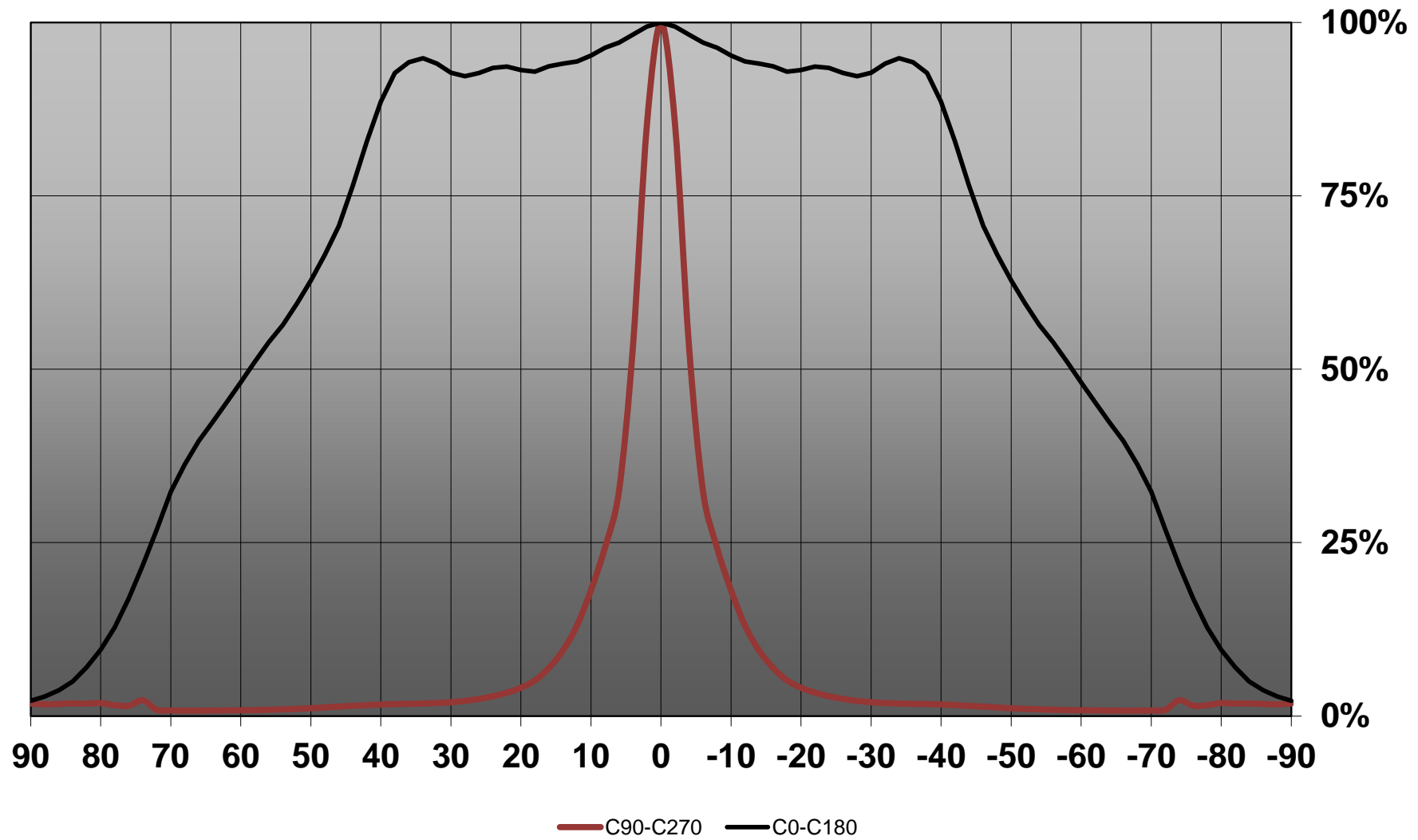

Relative intensity of CA10932\_FLARE-B (Oslon Square EC)

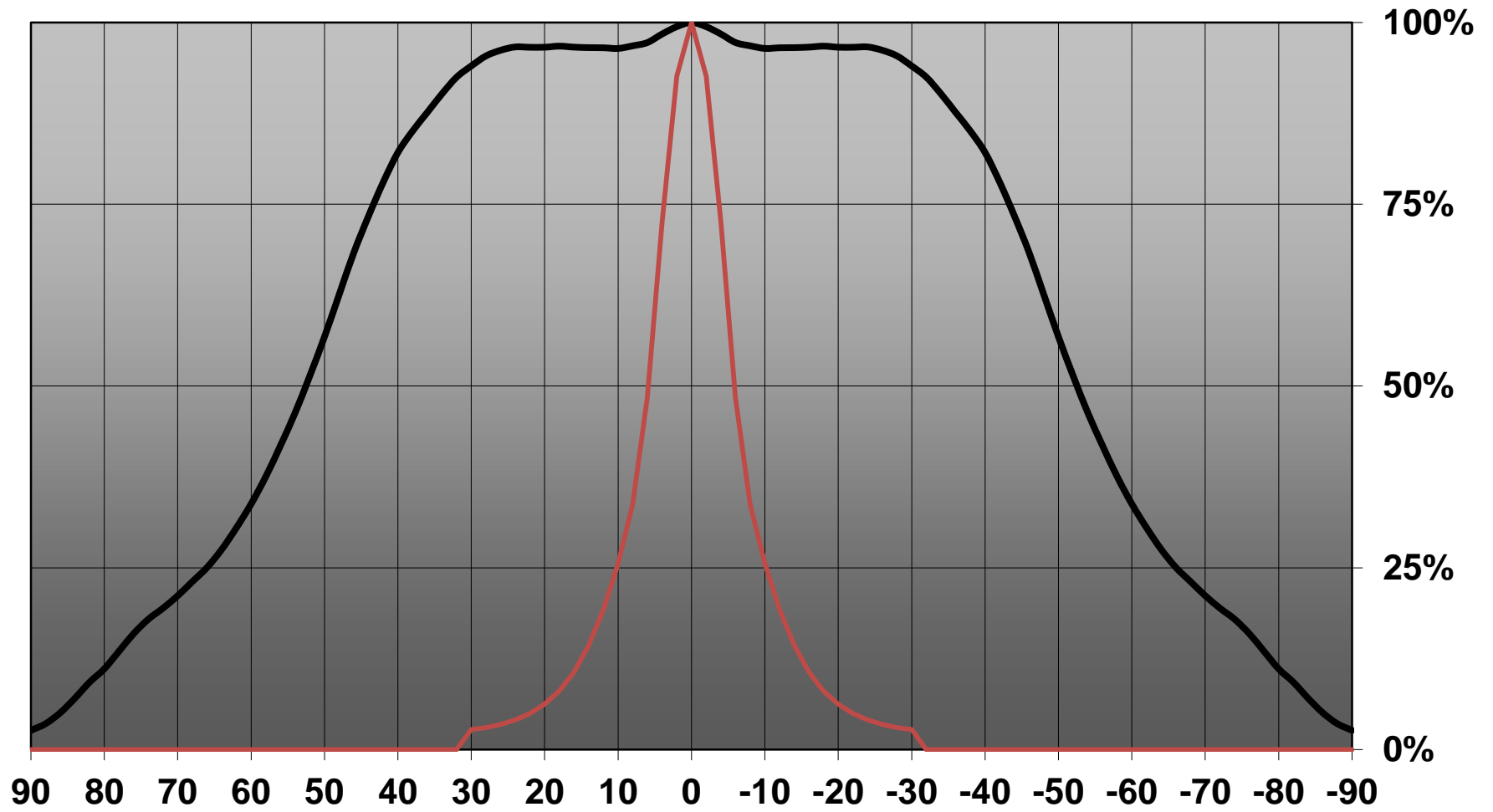

D

C

B

A

4

4

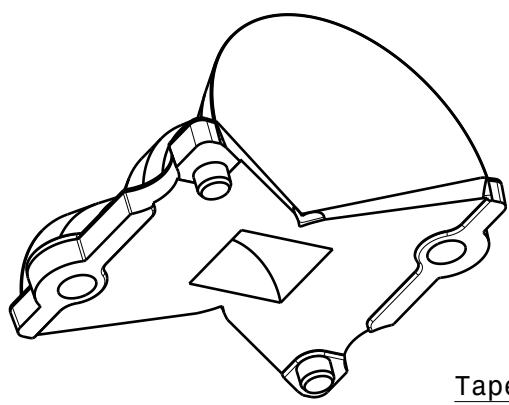

Isometric view  
2:1

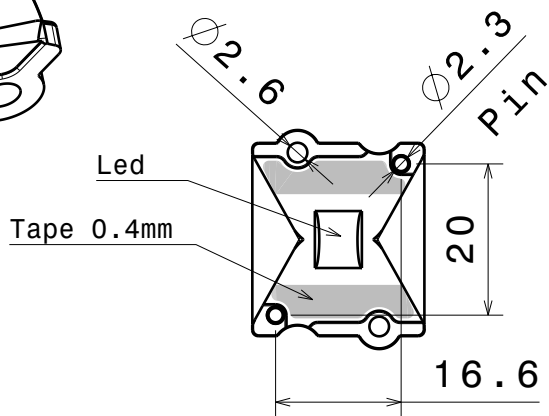

Bottom view

3

3

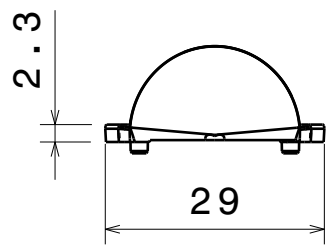

Right view

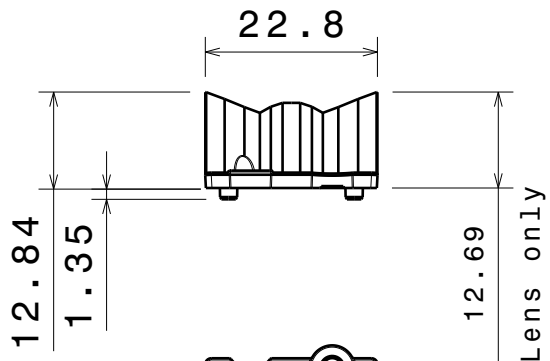

Front view

Part no.s:  
CA10932\_Flare-B

Part no. without tape fastening:  
C10946\_Flare-B

MATERIALS  
Lens: PMMA  
Tape: PU Foam

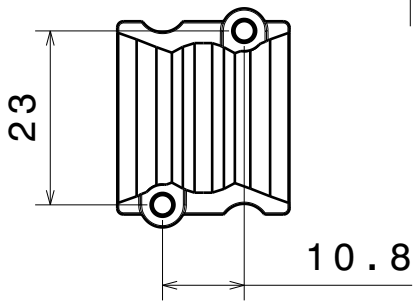

Top view

2

2

Tolerances if not otherwise shown  
According to DIN ISO 2768-1  
Linear measures:  
Up to 30mm class M, otherwise class C.  
According to DIN ISO 2768-2  
Form and position: class L

<b>LEDiL</b>	Ledil Oy Salorankatu 10 FIN 24240 SALO Finland		
	<b>DRAWING TITLE</b>		

THIRD ANGLE PROJECTION:

**FLARE-B series**

This drawing is the property of LEDiL Oy. It may not be reproduced, copied or communicated without a written agreement with LEDiL Oy.

<b>SIZE</b>	<b>PART NUMBER</b>	
A4		-

<b>SCALE</b> 1:1	<b>WEIGHT</b> -	<b>SHEET</b> 1/1
------------------	-----------------	------------------

1

1

D

A

**Ledil Oy CA10932\_Flare-B-XP-tape CA10932\_Flare-B-XP-tape / LDC (Linear)**

Luminaire: Ledil Oy CA10932\_Flare-B-XP-tape CA10932\_Flare-B-XP-tape  
Lamps: 1 x Cree XP-E (White)

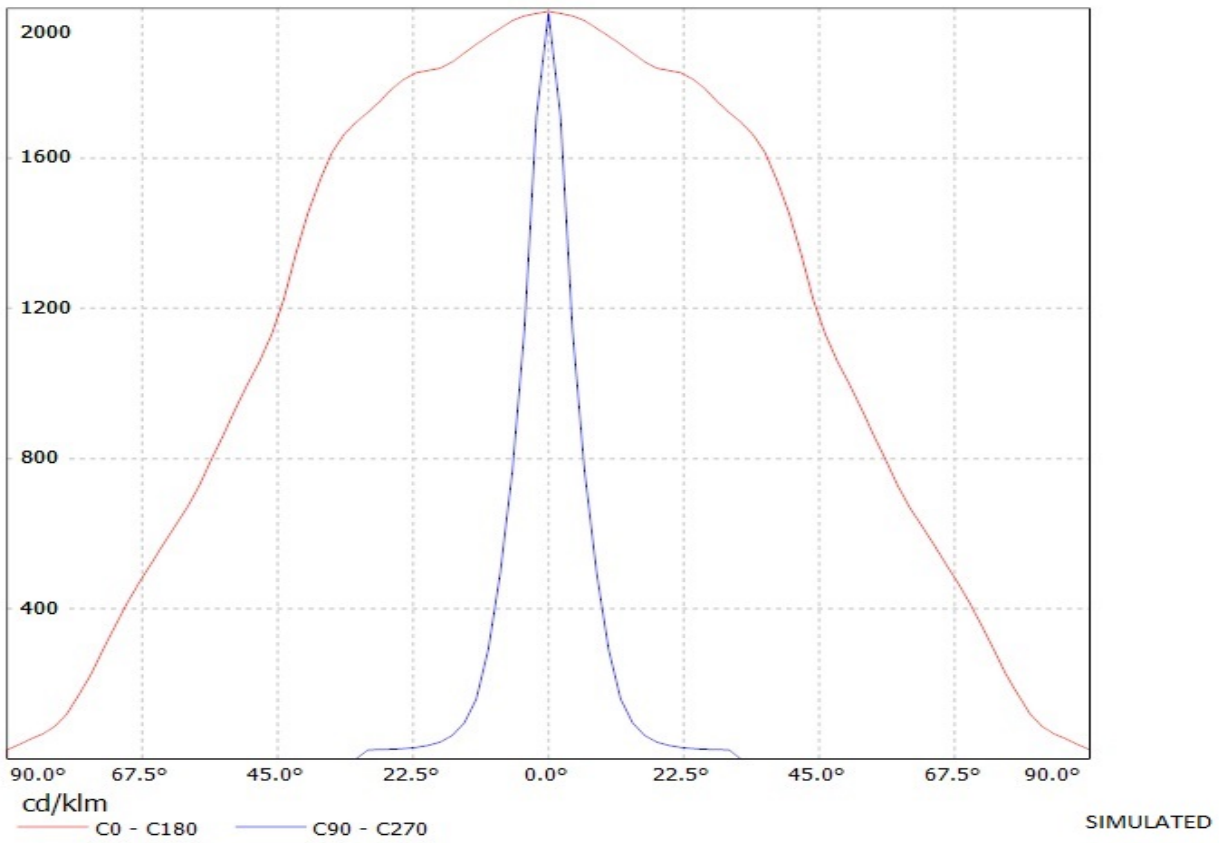



# Ledil Oy CA10932\_Flare-B-XP-G-tape CA10932\_Flare-B-XP-G-tape / LDC (Linear)

Luminaire: Ledil Oy CA10932\_Flare-B-XP-G-tape CA10932\_Flare-B-XP-G-tape  
Lamps: 1 x Cree XP-G (White)

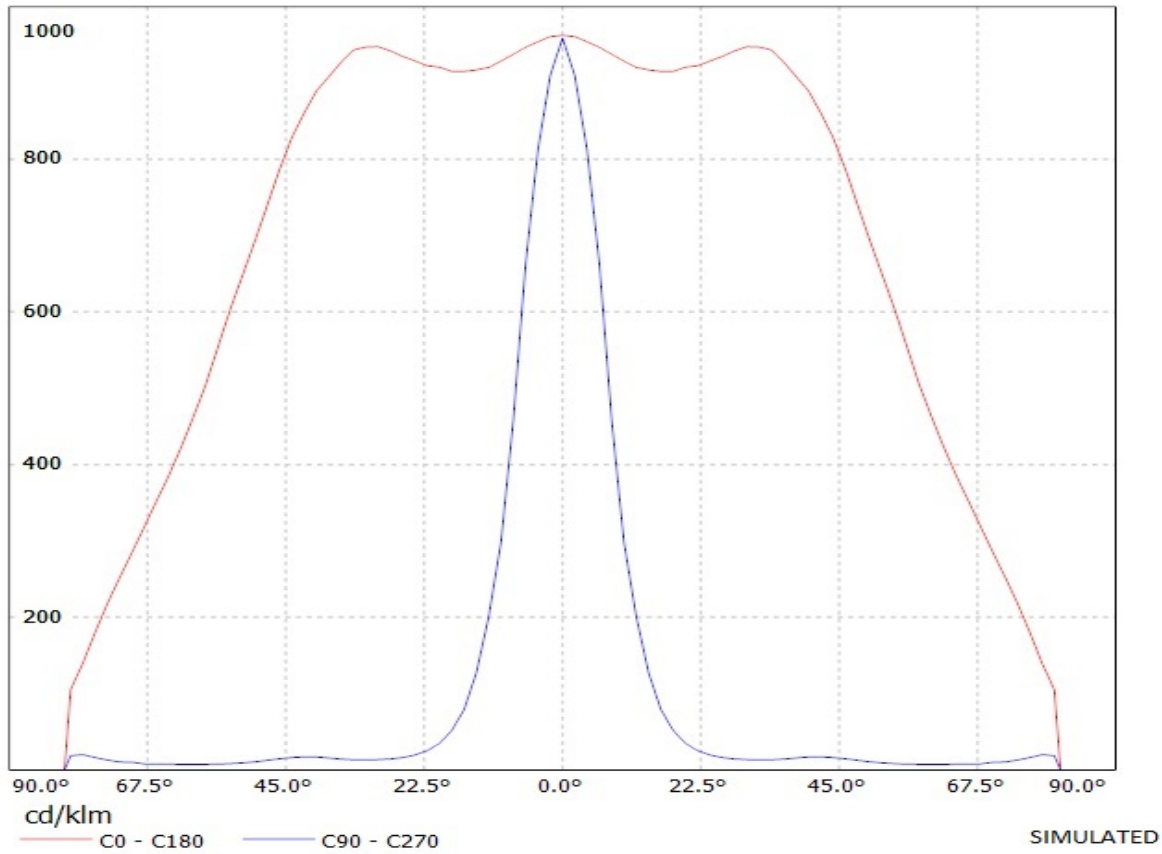

Luminaire: LEDIL OY CA10932\_FLARE-B (XB-D) Efficiency=93%  
Lamps: 1 x Cree XB-D white (97lm @ 250mA)

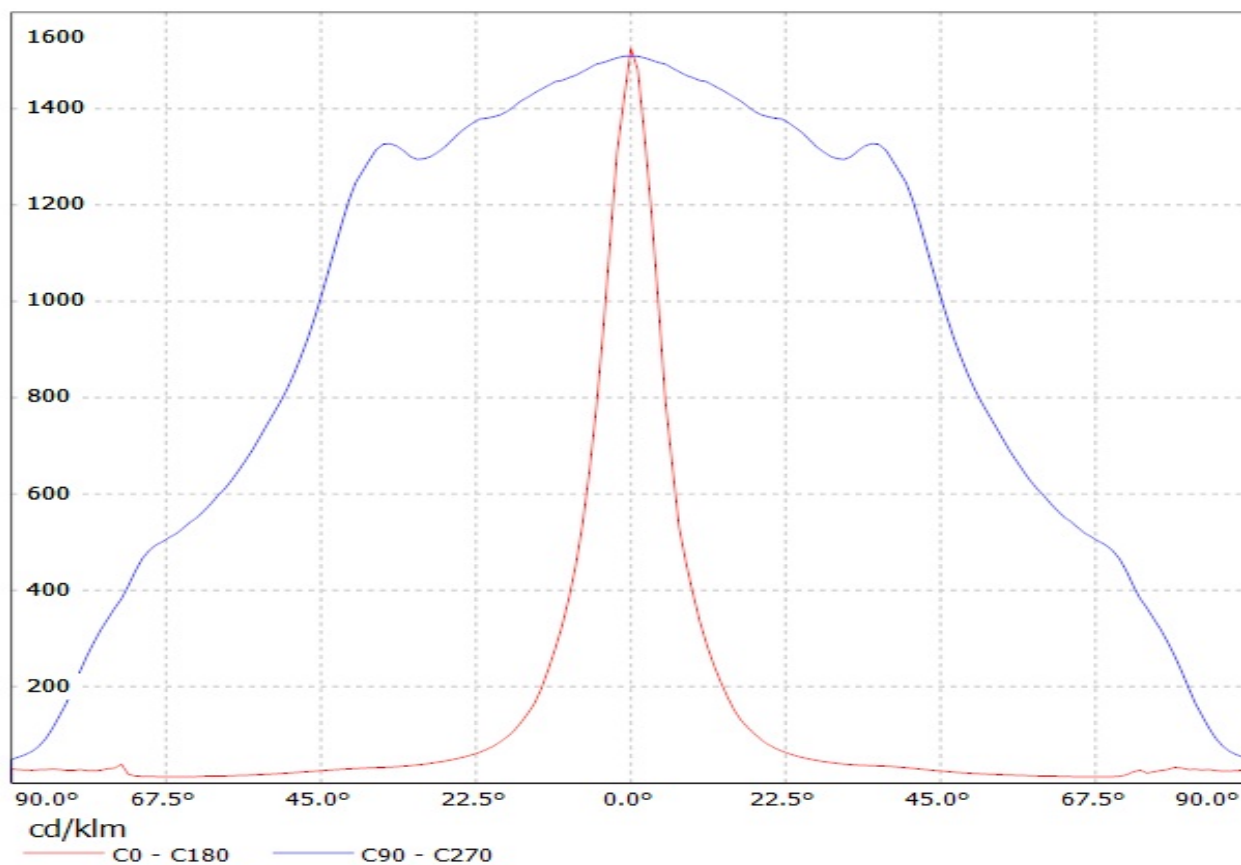

Luminaire: Ledil Oy CA10932\_FLARE-B\_(XP-E2) Efficiency=94%  
Lamps: 1 x Cree XP-E2 (92lm @ 250mA) CCT=5500K P=0.8W I=250mA

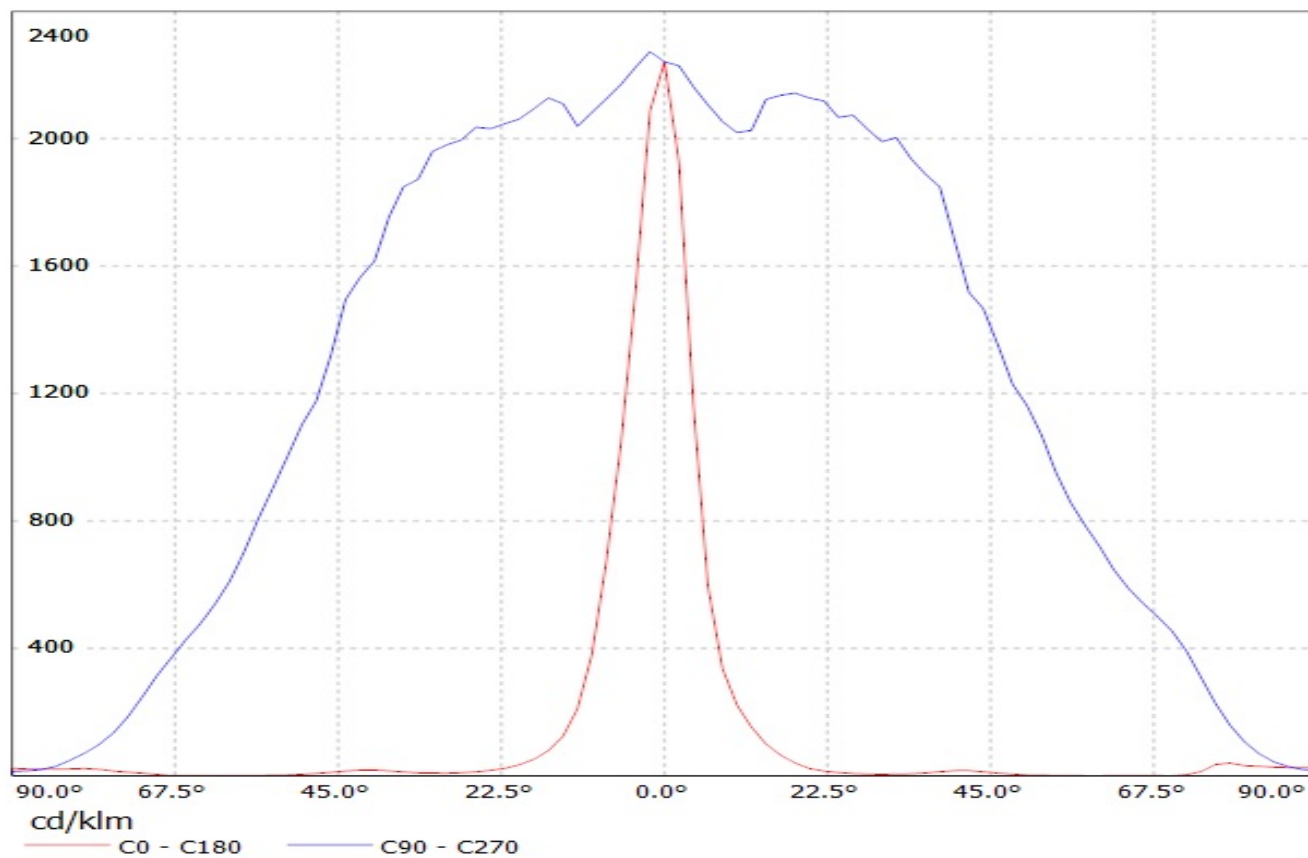

# Ledil Oy CA10932\_Flare-B-RE-tape CA10932\_Flare-B-RE-tape / LDC (Linear)

Luminaire: Ledil Oy CA10932\_Flare-B-RE-tape CA10932\_Flare-B-RE-tape  
Lamps: 1 x Luxeon Rebel (white/neut)

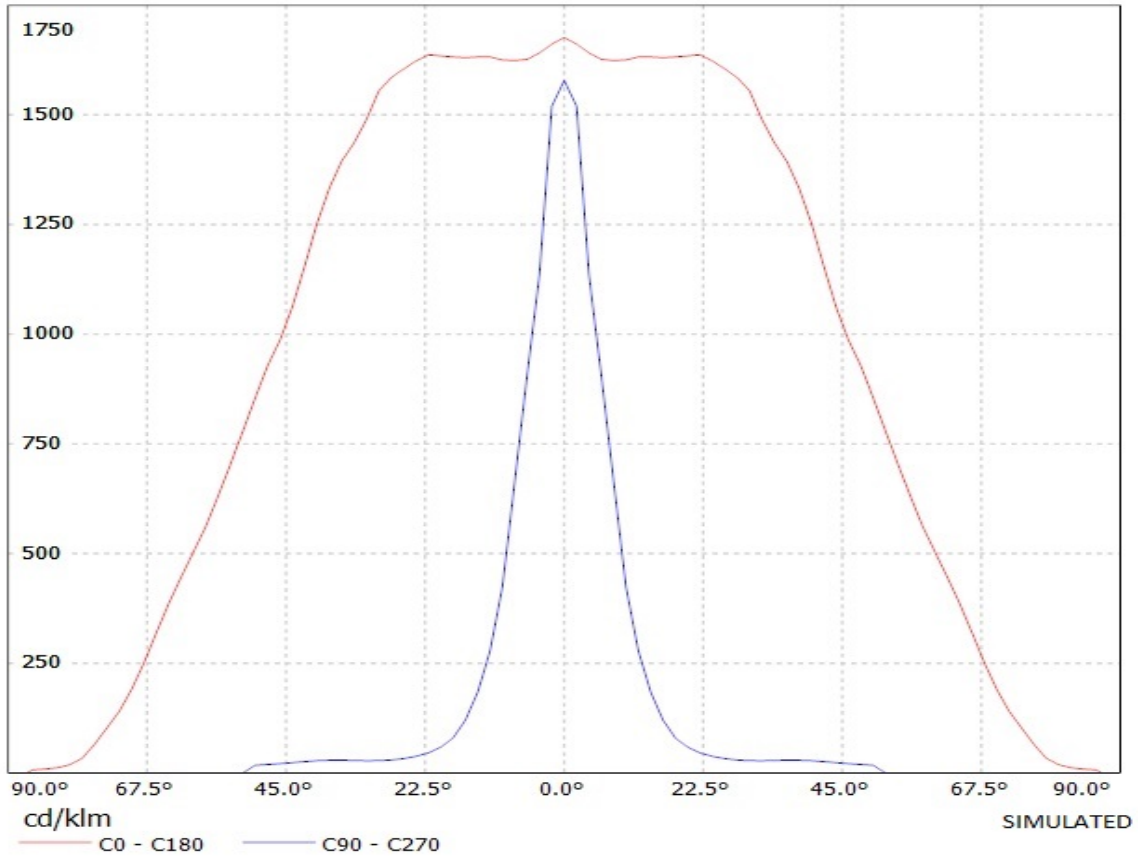

Ledil Oy C10922\_GT4-OSL-M C10922\_GT4-OSL-M SSL80 333lm @ 250mA LOR=87% / LDC  
(Linear)

Luminaire: Ledil Oy C10922\_GT4-OSL-M C10922\_GT4-OSL-M SSL80 333lm @ 250mA LOR=87%  
Lamps: 1 x Osram Oslon SSL80

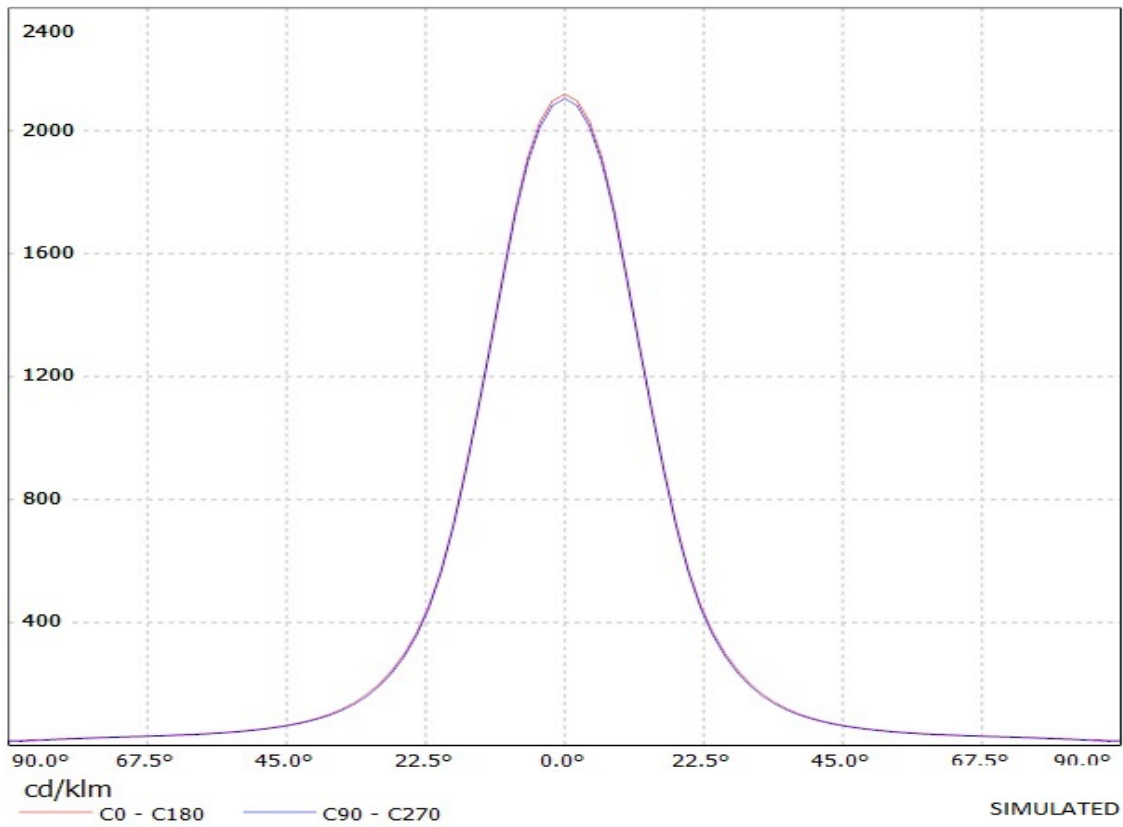

# LEDiL Oy CA10932\_FLARE-B\_(LUXEON\_T)\_2 Eff.92.7% / LDC (Linear)

Luminaire: LEDiL Oy CA10932\_FLARE-B\_(LUXEON\_T)\_2 Eff.92.7%  
Lamps: 1 x LUXEON T (74lm@250mA)

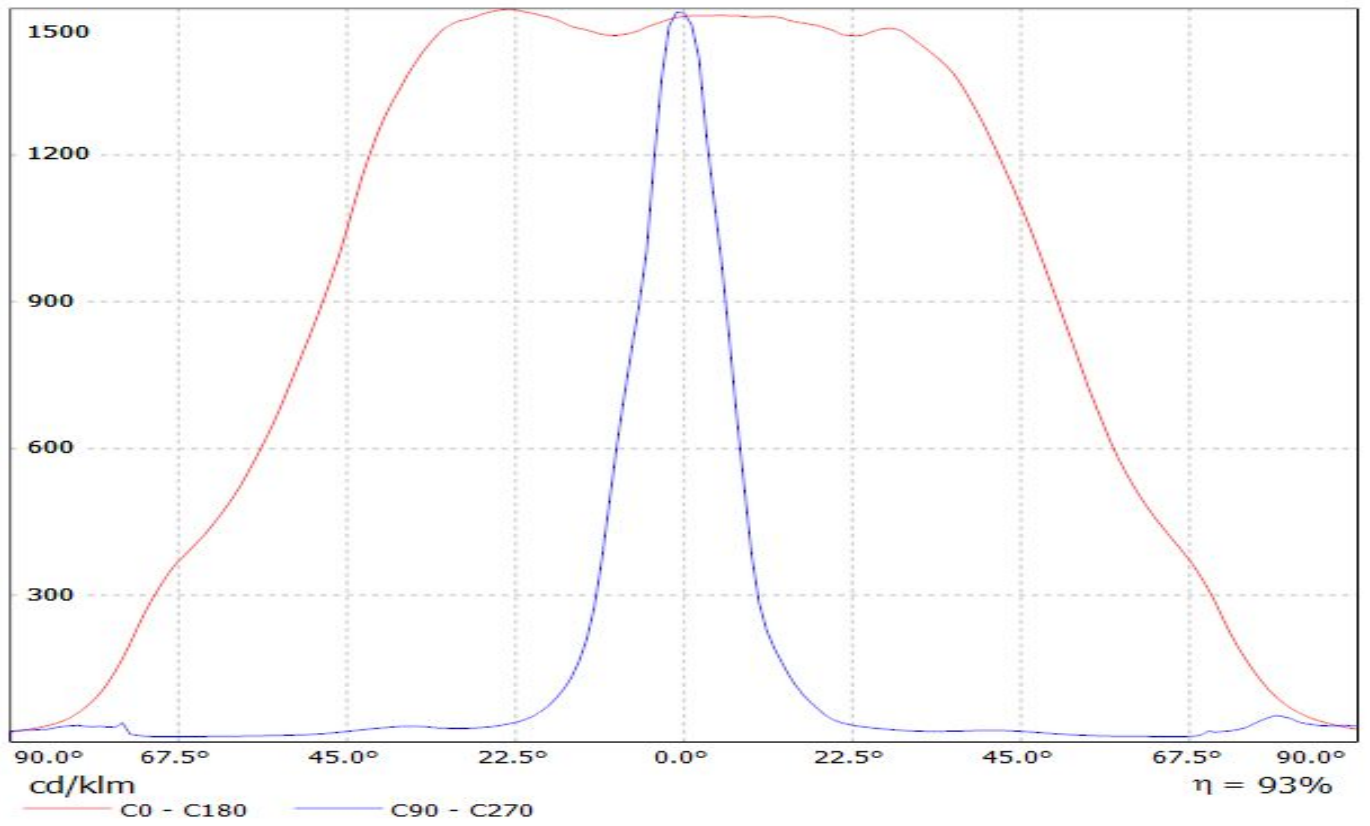

Luminaire: LEDil Oy CA10932\_FLARE-B\_(Luxeon\_TX)  
Lamps: 1 x Luxeon TX (96lm @ 250mA)  $\bar{P}=0.7W$   $I=250mA$

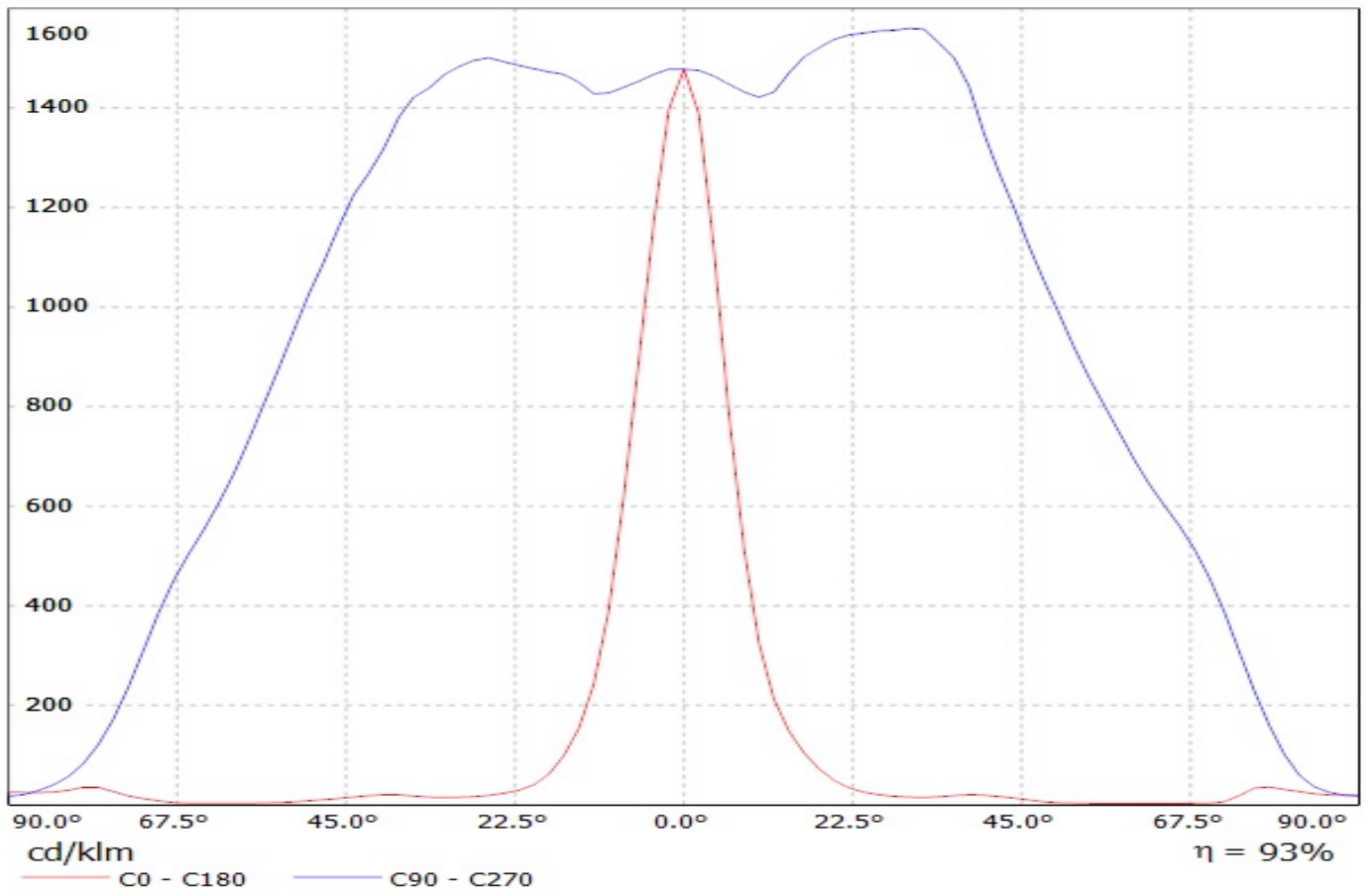

Luminaire: LEDiL Oy CA10932\_FLARE-B\_(NVSL219CE)  
Lamps: 1 x Nichia\_NVSL219CE\_101.227lm@250mA\_P=0.713404W\_I=0.25A

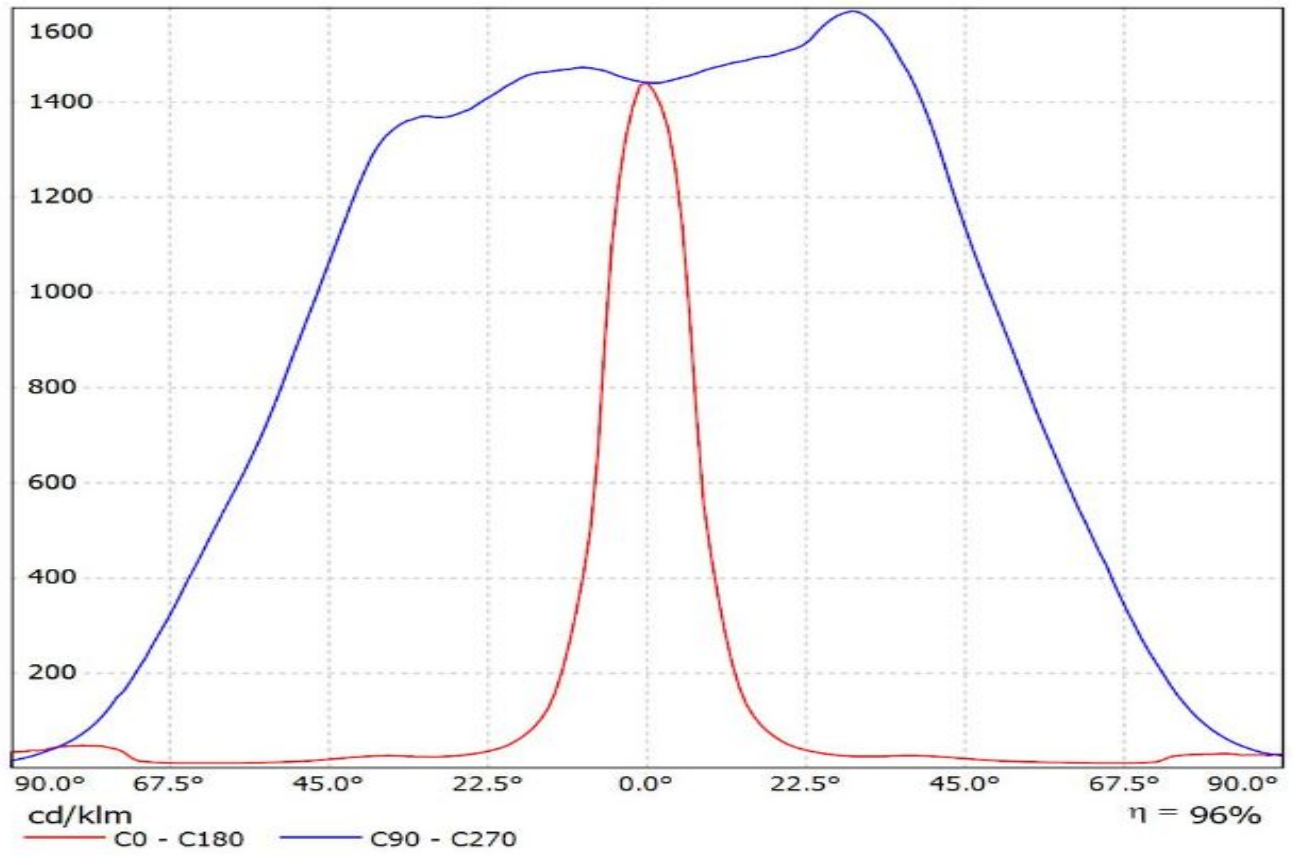



Luminaire: LEDiL Oy FLARE-B (SSL150)

Lamps: 1 x Osram\_Oslon\_SSL150\_(LCW CRUP.EC-KTLP-607Q-1)\_84lm@250mA\_P=0.745802W\_I=249.9mA

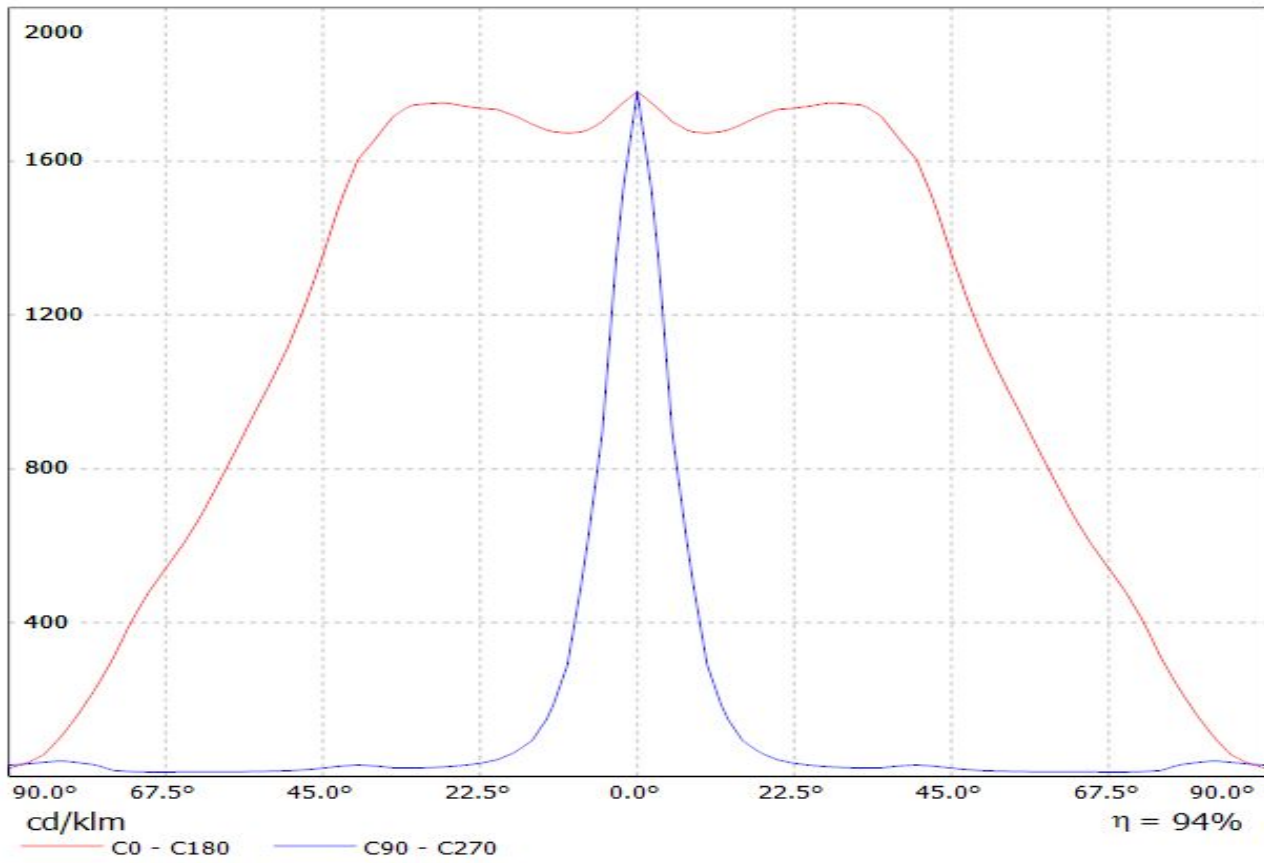

# Ledil Oy CA10932\_Flare-B-XP-tape CA10932\_Flare-B-XP-tape / LDC (Polar)

Luminaire: Ledil Oy CA10932\_Flare-B-XP-tape CA10932\_Flare-B-XP-tape

Lamps: 1 x Cree XP-E (White)

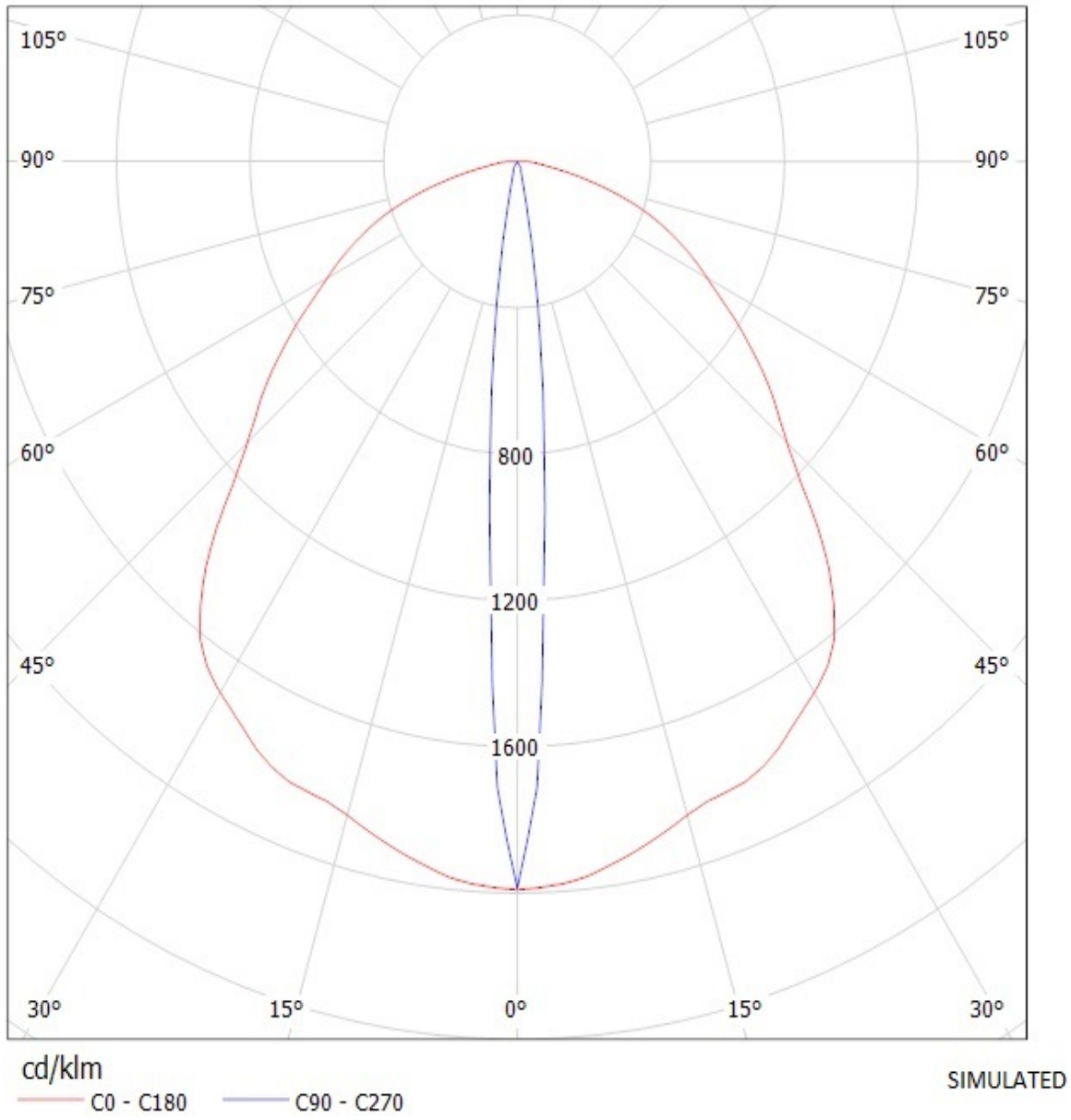

# Ledil Oy CA10932\_Flare-B-XP-G-tape CA10932\_Flare-B-XP-G-tape / LDC (Polar)

Luminaire: Ledil Oy CA10932\_Flare-B-XP-G-tape CA10932\_Flare-B-XP-G-tape  
Lamps: 1 x Cree XP-G (White)

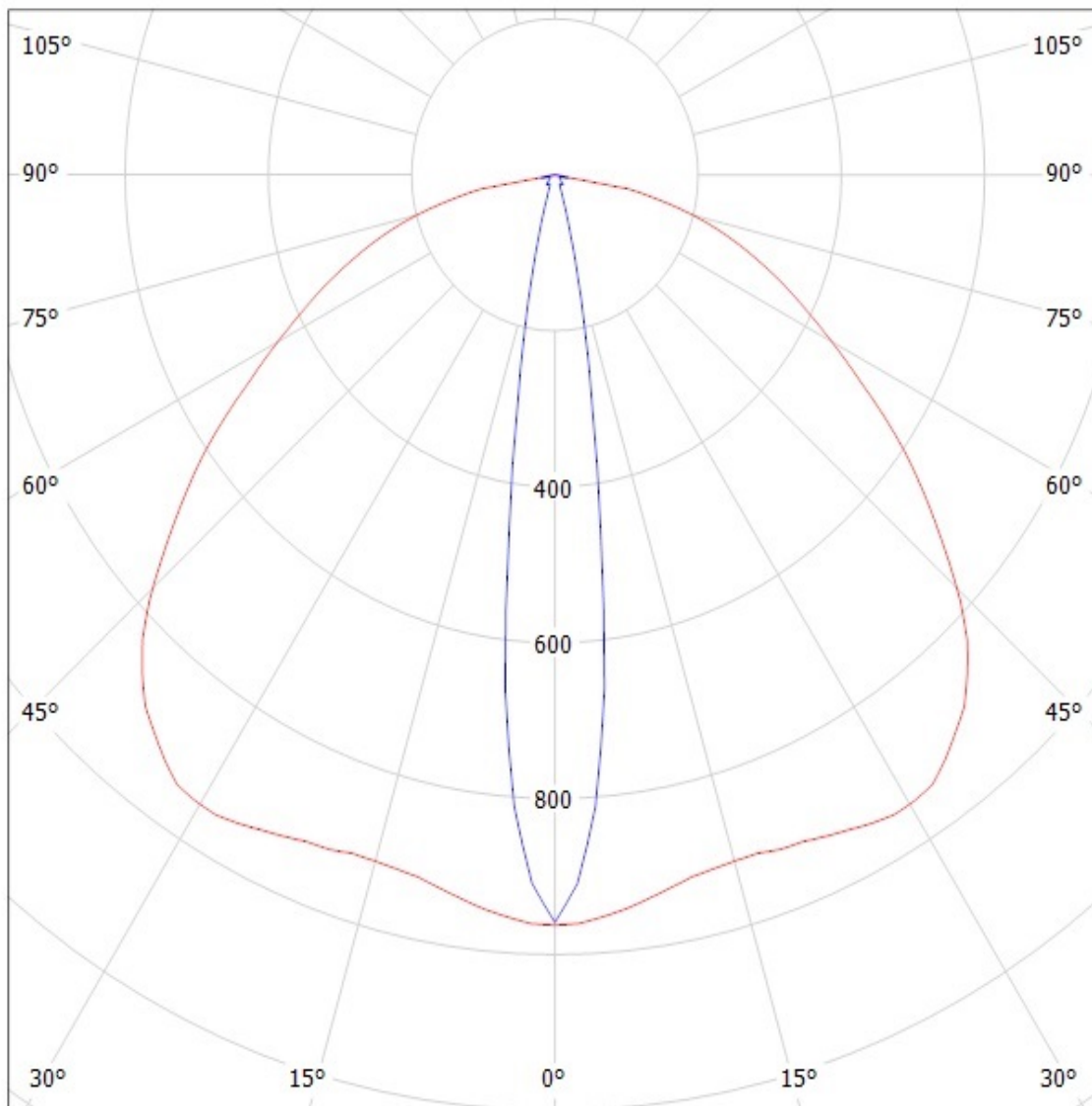

cd/klm

— C0 - C180 — C90 - C270

SIMULATED

Luminaire: LEDIL OY CA10932\_FLARE-B (XB-D) Efficiency=93%  
Lamps: 1 x Cree XB-D white (97lm @ 250mA)

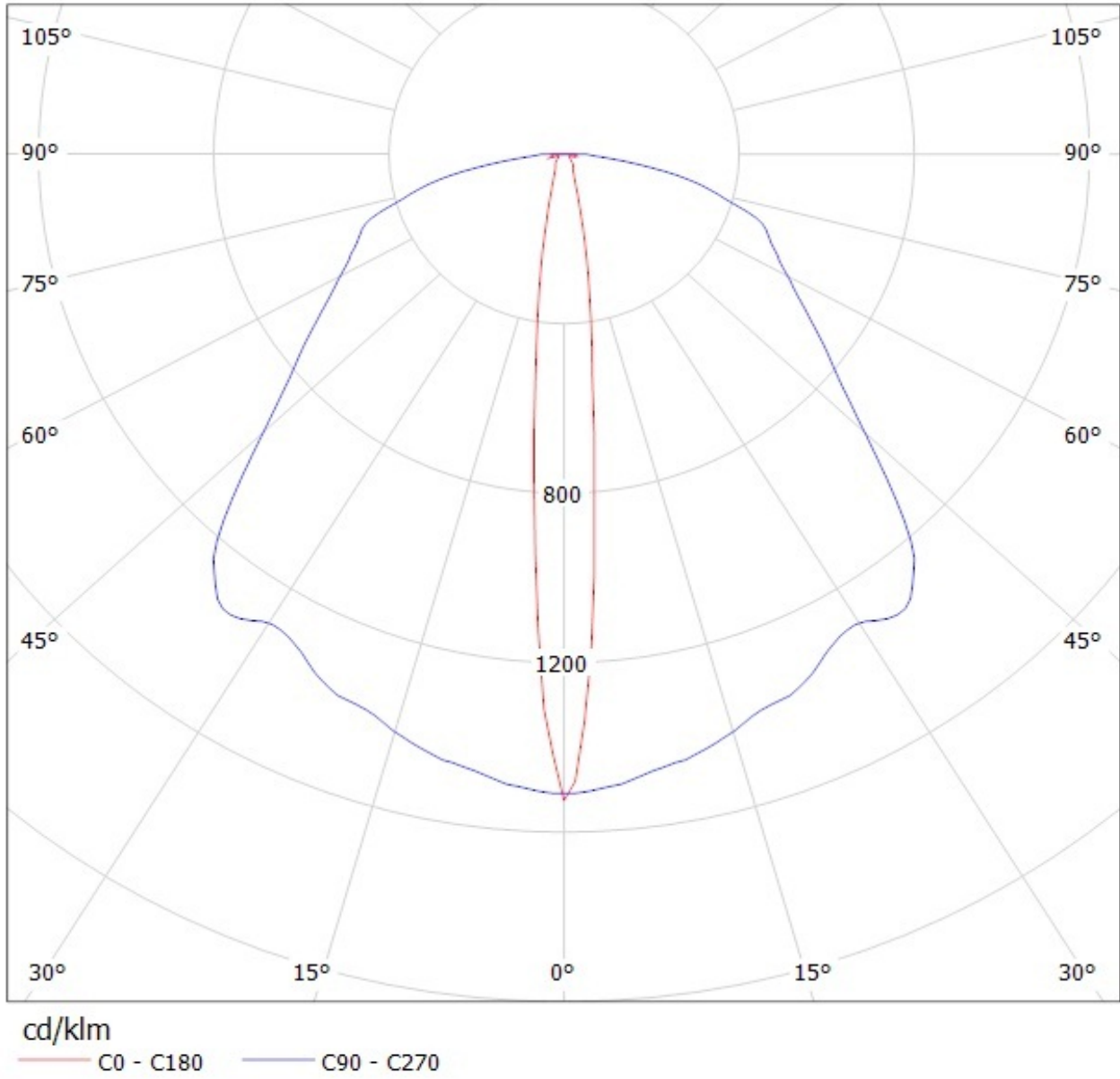

Luminaire: Ledil Oy CA10932\_FLARE-B\_(XP-E2) Efficiency=94%  
Lamps: 1 x Cree XP-E2 (92lm @ 250mA) CCT=5500K P=0.8W I=250mA

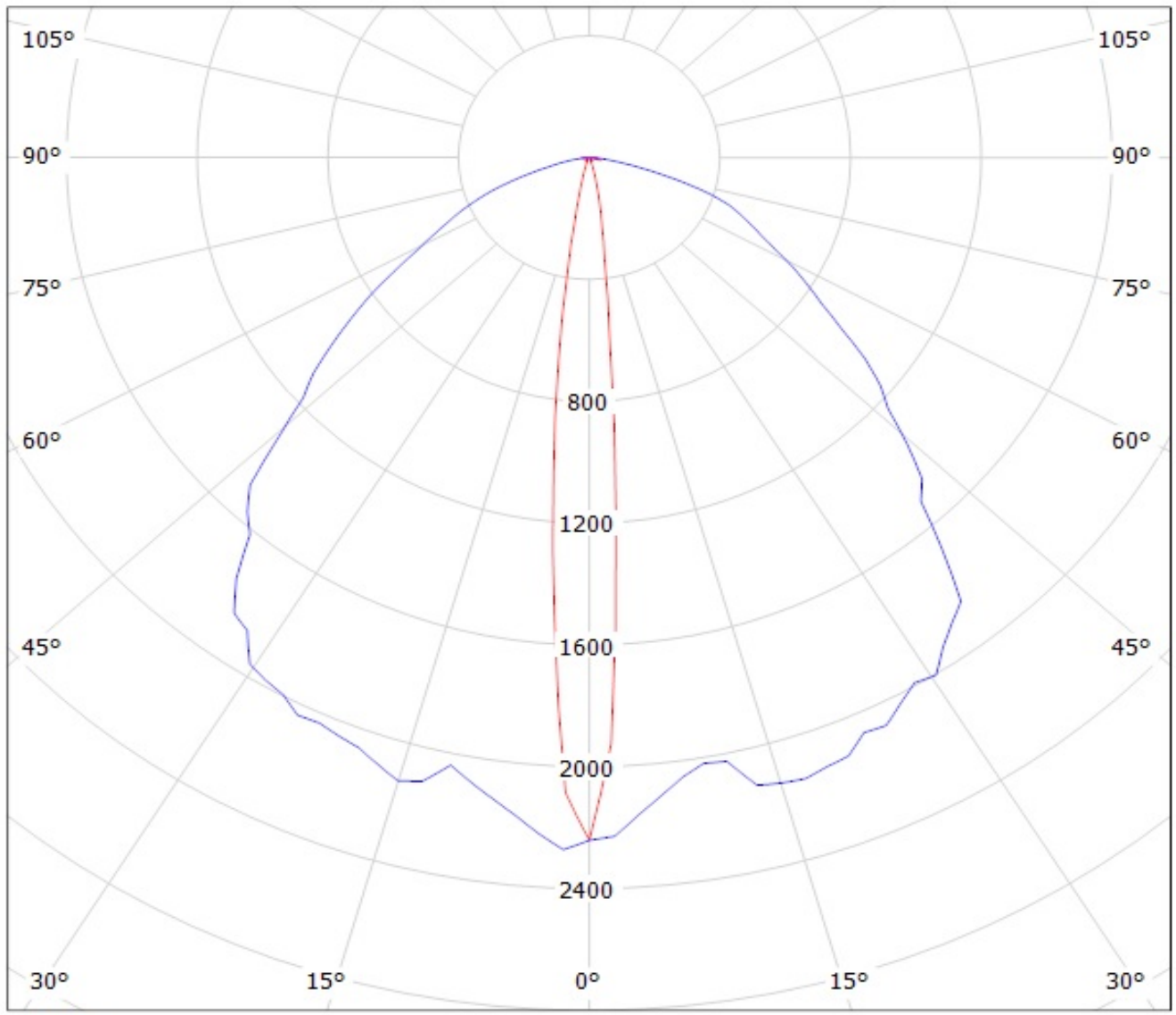

cd/klm  
— C0 - C180 — C90 - C270

# Ledil Oy CA10932\_Flare-B-RE-tape CA10932\_Flare-B-RE-tape / LDC (Polar)

Luminaire: Ledil Oy CA10932\_Flare-B-RE-tape CA10932\_Flare-B-RE-tape  
Lamps: 1 x Luxeon Rebel (white/neut)

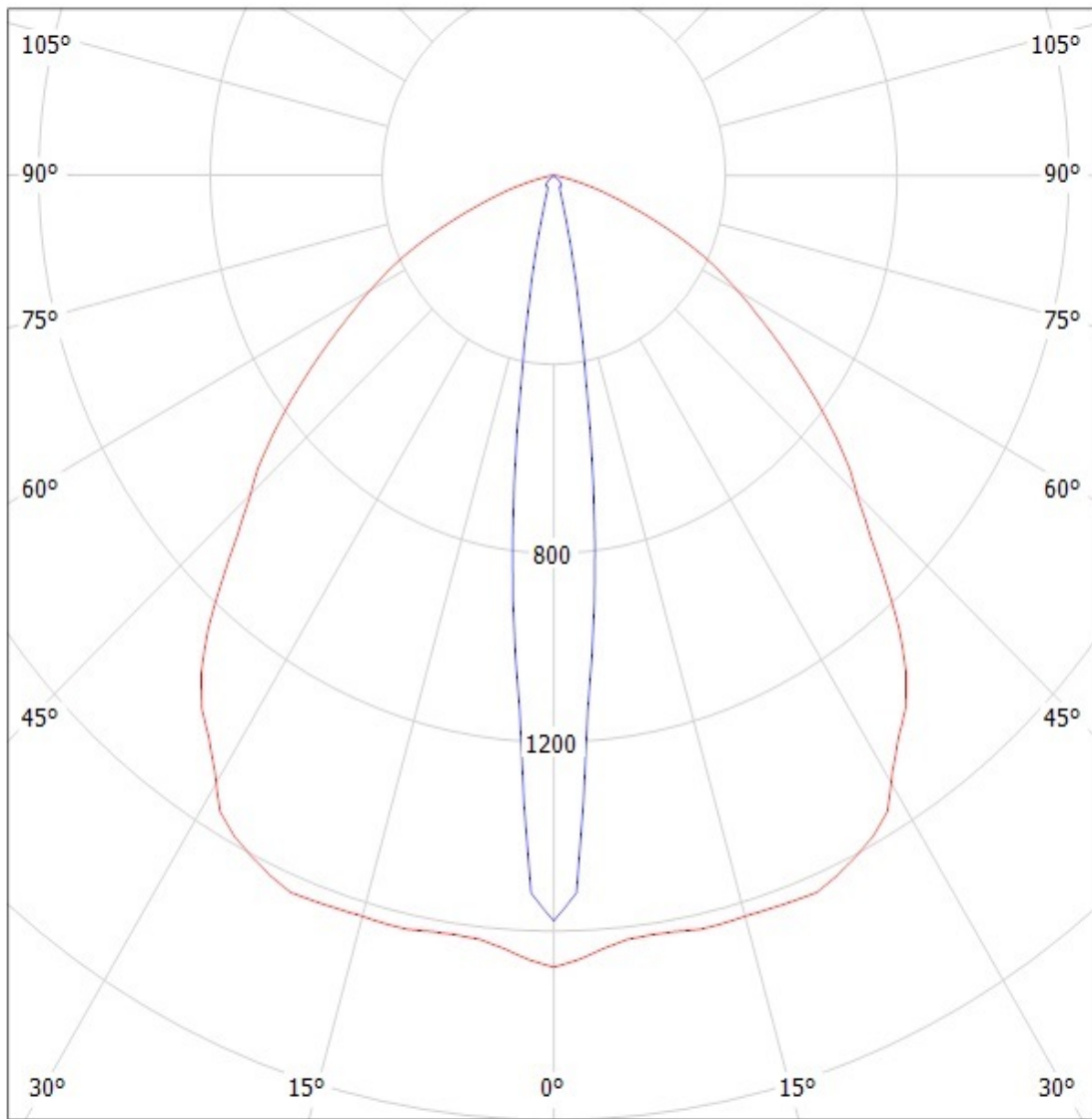

cd/klm

— C0 - C180 — C90 - C270

SIMULATED

Ledil Oy C10922\_GT4-OSL-M C10922\_GT4-OSL-M SSL80 333lm @ 250mA LOR=87% / LDC  
(Polar)

Luminaire: Ledil Oy C10922\_GT4-OSL-M C10922\_GT4-OSL-M SSL80 333lm @ 250mA LOR=87%  
Lamps: 1 x Osram Oslon SSL80

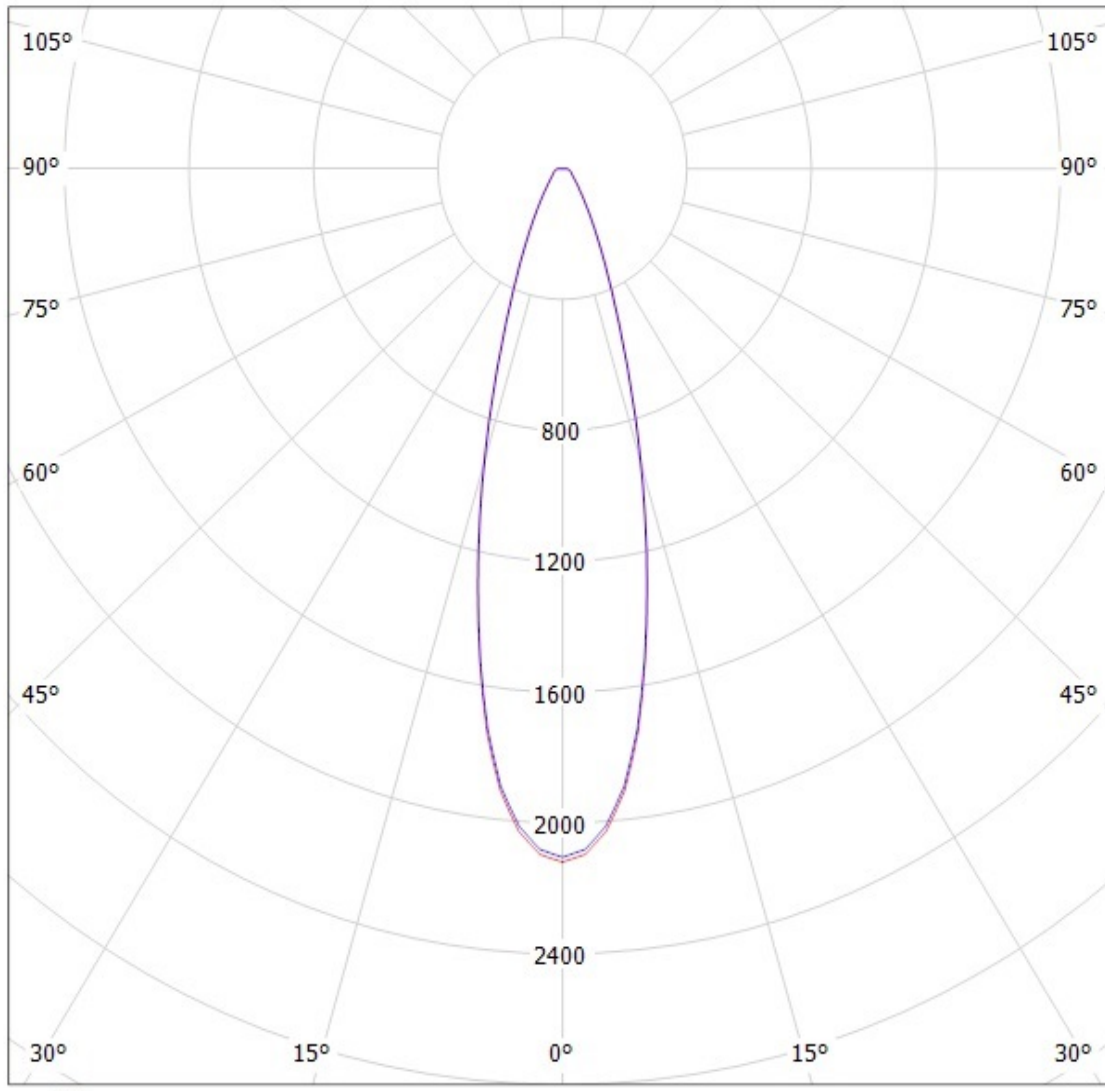

cd/klm

— C0 - C180 — C90 - C270

SIMULATED



# LEDiL Oy CA10932\_FLARE-B\_(LUXEON\_T)\_2 Eff.92.7% / LDC (Polar)

Luminaire: LEDiL Oy CA10932\_FLARE-B\_(LUXEON\_T)\_2 Eff.92.7%

Lamps: 1 x LUXEON T (74lm@250mA)

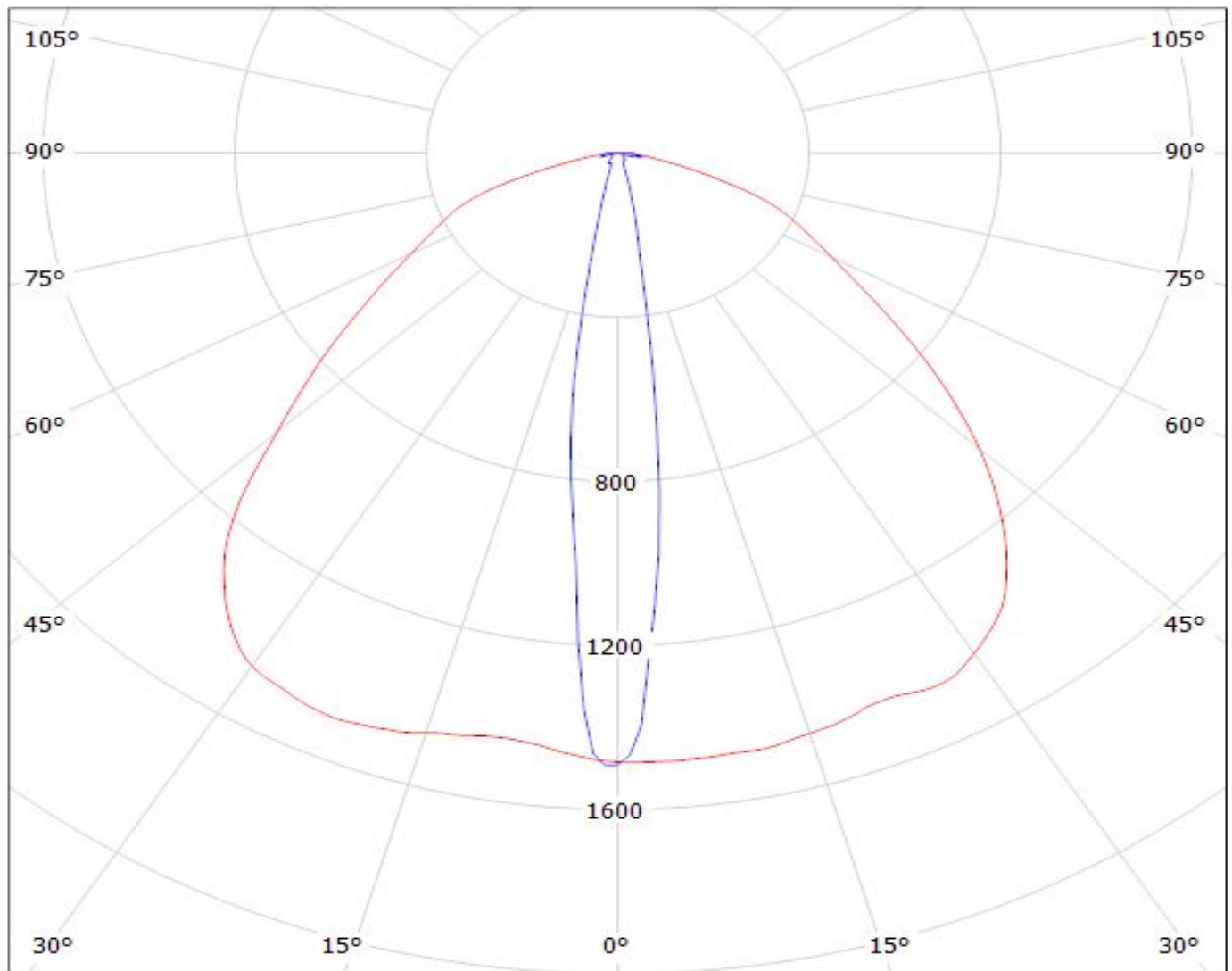

cd/klm

— C0 - C180

— C90 - C270

$\eta = 93\%$



Luminaire: LEDil Oy CA10932\_FLARE-B\_(Luxeon\_TX)  
Lamps: 1 x Luxeon TX (96lm @ 250mA) P=0.7W I=250mA

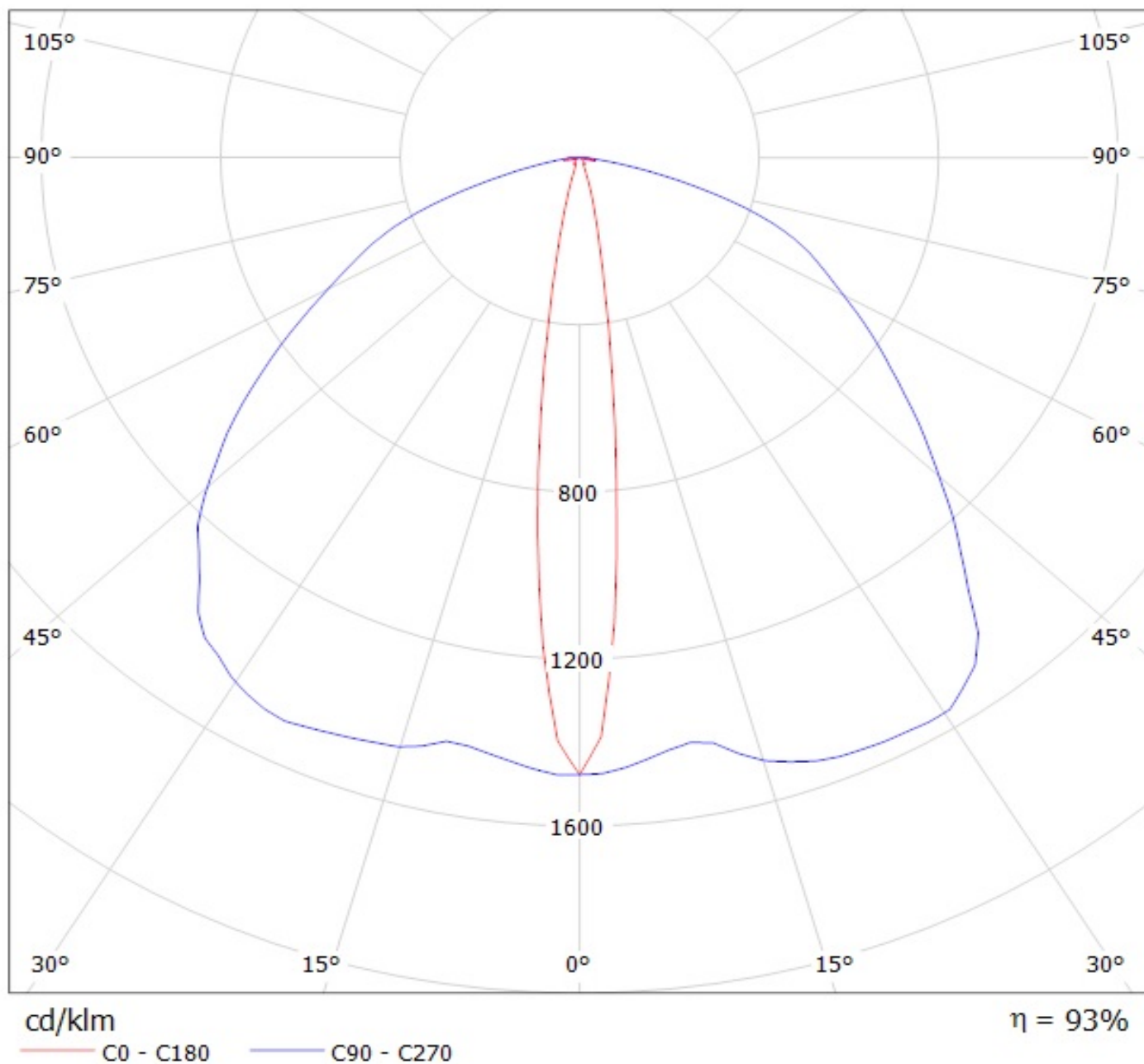

Luminaire: LEDiL Oy CA10932\_FLARE-B\_(NVSL219CE)

Lamps: 1 x Nichia\_NVSL219CE\_101.227lm@250mA\_P=0.713404W\_I=0.25A

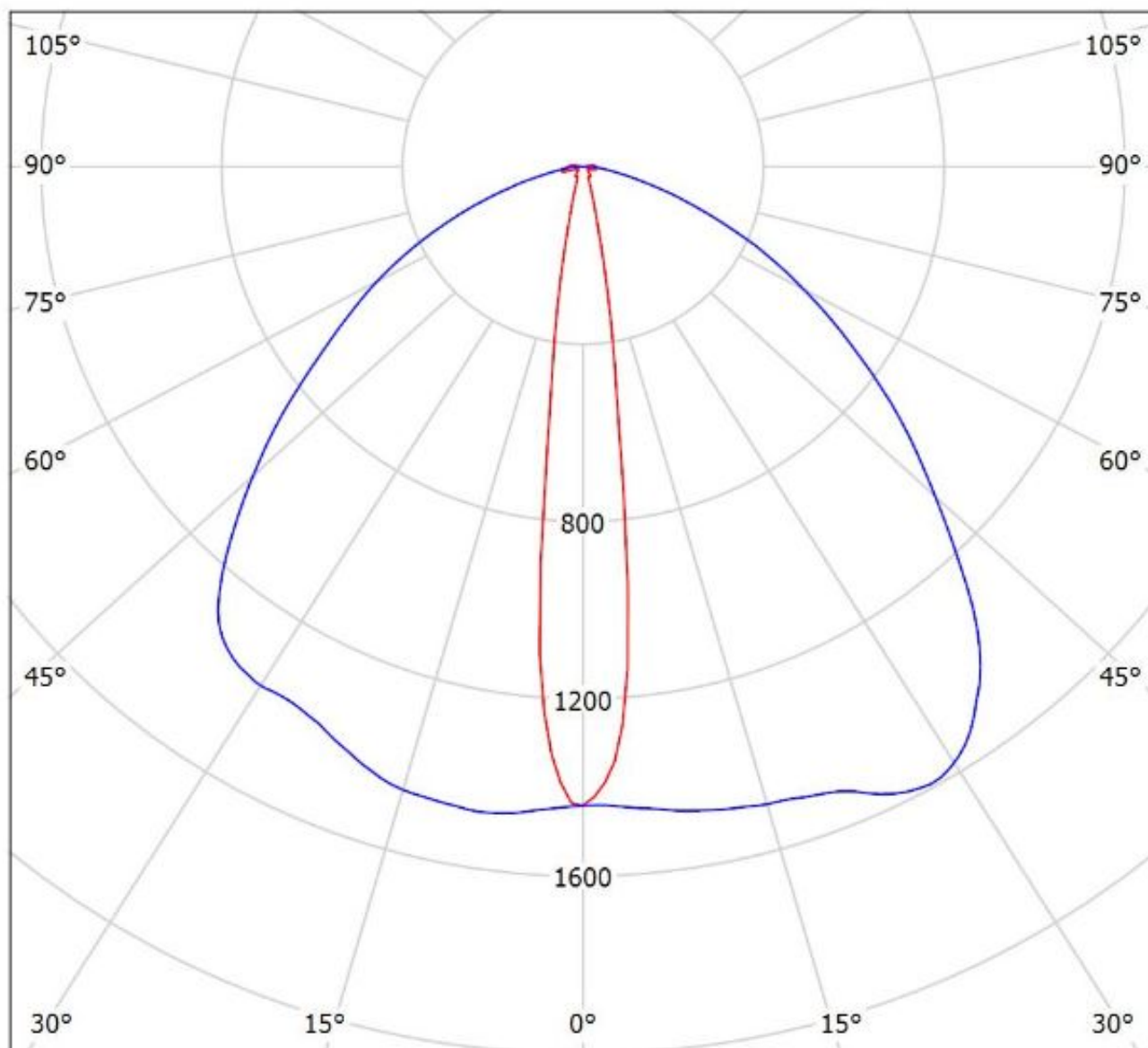

cd/klm

— C0 - C180 — C90 - C270

$\eta = 96\%$

Luminaire: LEDiL Oy FLARE-B\_(SSL150)

Lamps: 1 x Osram\_Oslon\_SSL150\_(LCW CRUP.EC-KTLP-607Q-1)\_84lm@250mA\_P=0.745802W\_I=249.9mA

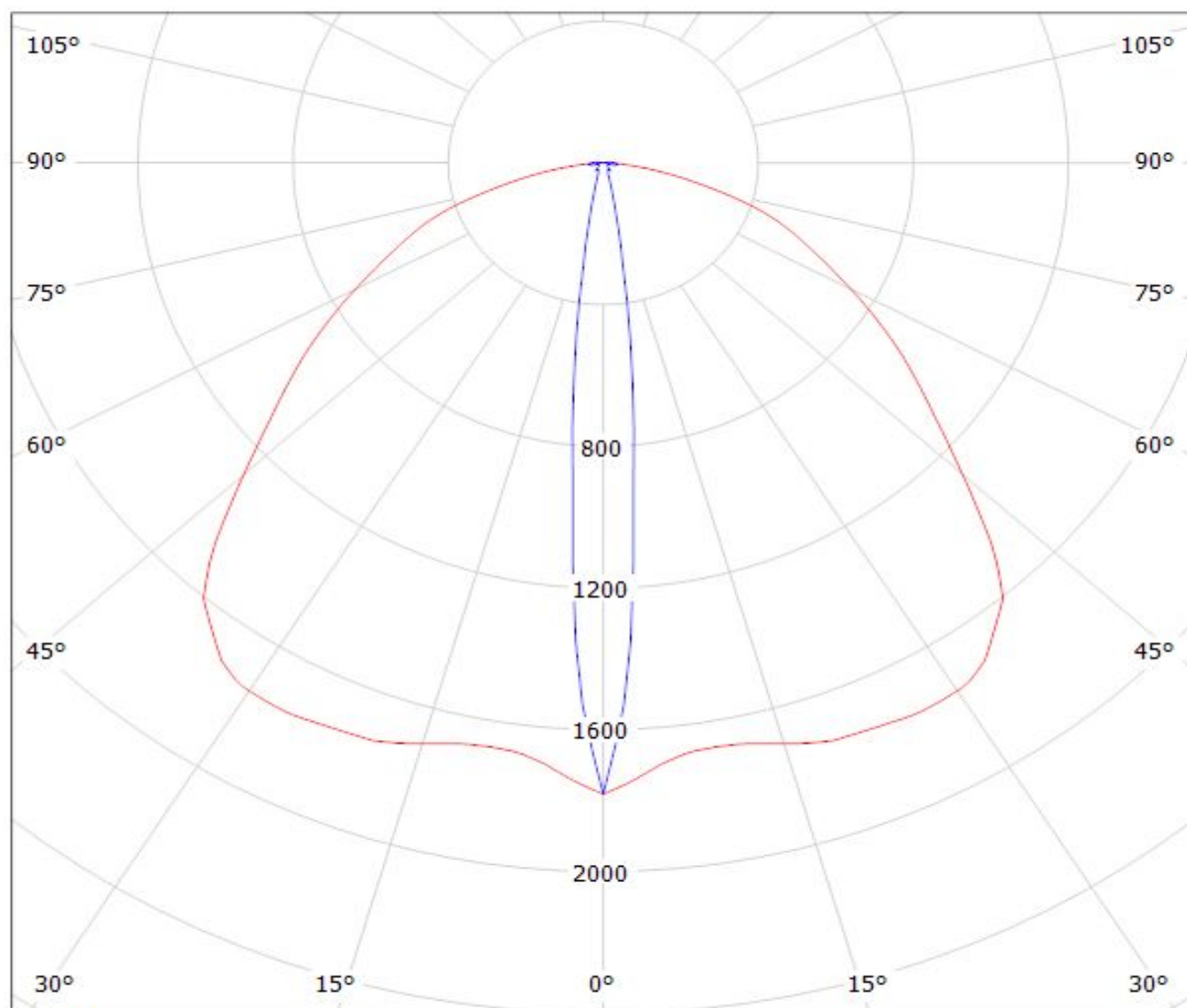

cd/klm

— C0 - C180

— C90 - C270

$\eta = 94\%$

**NOTE: The typical divergence will be changed by different color, chip size and chip position tolerance. The typical total divergence is the full angle measured where the luminous intensity is half of the peak value.**