

**Product number C13604\_STRADA-2X2-FN**

|                 |                          |                     |                        |
|-----------------|--------------------------|---------------------|------------------------|
| Family          | Strada-Module            | FWHM                | (simulated) Asymmetric |
| Type            | Lens array               | Efficiency          | 91 %                   |
| LED             | XT-E                     | cd/lm               | 1.400                  |
| Color           | Clear                    | Gerber File         | Available              |
| Diameter        | 50 + 50 mm               | Forward throw optic |                        |
| Height          | 10 mm                    |                     |                        |
| Style           | Square                   |                     |                        |
| Optic Material  | PMMA                     |                     |                        |
| Holder Material | -                        |                     |                        |
| Fastening       | ["glue", "pin", "screw"] |                     |                        |
| Status          | Production ready         |                     |                        |

**Product number C14164\_STRADA-2X2-ME-WIDE1**

|                 |                          |   |                        |
|-----------------|--------------------------|---|------------------------|
| Family          | Strada-Module            | FWHM  | (simulated) Asymmetric |
| Type            | Lens array               | Efficiency  | (simulated) 84 %       |
| LED             | XT-E                     | cd/lm   | -                      |
| Color           | Clear                    | Gerber File                                       | Available              |
| Diameter        | 50x50 mm                 | Optical measurement done with a flat cover glass. |                        |
| Height          | 8.3 mm                   |   |                        |
| Style           | Square                   |   |                        |
| Optic Material  | PMMA                     |   |                        |
| Holder Material | -                        |   |                        |
| Fastening       | ["glue", "screw", "pin"] |   |                        |
| Status          | Production ready         |   |                        |

**Product number C15014\_STRADA-2X2-T4-B**

|                 |                  |             |                        |
|-----------------|------------------|-------------|------------------------|
| Family          | Strada-Module    | FWHM        | (simulated) Asymmetric |
| Type            | Lens             | Efficiency  | -                      |
| LED             | XT-E             | cd/lm       | -                      |
| Color           | Clear            | Gerber File | Available              |
| Diameter        | 50x50 mm         |             |                        |
| Height          | 9.02 mm          |             |                        |
| Style           | Square           |             |                        |
| Optic Material  | PMMA             |             |                        |
| Holder Material | -                |             |                        |
| Fastening       | ["screw", "pin"] |             |                        |
| Status          | Production ready |             |                        |

**Product number FN15180\_STRADA-2X2S-T3**

|                 |               |  |                        |
|-----------------|---------------|--|------------------------|
| Family          | Strada-Module | FWHM   | (simulated) Asymmetric |
| Type            | Pack          | Efficiency   | (simulated) 90 %       |
| LED             | XT-E          | cd/lm  | -                      |
| Color           | Clear         | Gerber File  | Available              |
| Diameter        | 50+50 mm      | lesna type 3 medium light distribution in typical setup. |                        |
| Height          | 7.23 mm       |  |                        |
| Style           | Rectang       | M3 screw with ~7mm washer recommended.                   |                        |
| Optic Material  | Silicone      |  |                        |
| Holder Material | -             |  |                        |
| Fastening       | ["screw"]     |  |                        |
| Status          | Promotion     |  |                        |



**Product number C12360\_STRADA-2X2-DNW**

|                 |                          |   |                    |
|-----------------|--------------------------|---|--------------------|
| Family          | Strada-Module            | FWHM  | Asymmetric degrees |
| Type            | Lens array               | Efficiency  | 93 %               |
| LED             | XT-E                     | cd/lm   | 0.290              |
| Color           | Clear                    | Gerber File   | Available          |
| Diameter        | 50x50 mm                 | <a href="http://oemwebshop.philips.com/fortimo-fastflex-led-board-2x8-740-da-g3.html">http://oemwebshop.philips.com/fortimo-fastflex-led-board-2x8-740-da-g3.html</a> |                    |
| Height          | 11.27 mm                 |   |                    |
| Style           | Square                   |   |                    |
| Optic Material  | PMMA                     |   |                    |
| Holder Material | -                        |   |                    |
| Fastening       | ["screw", "glue", "pin"] |   |                    |
| Status          | Production ready         |   |                    |

**Product number C12362\_STRADA-2X2-DWC**

|                 |                          |   |                    |
|-----------------|--------------------------|---|--------------------|
| Family          | Strada-Module            | FWHM  | Asymmetric degrees |
| Type            | Lens array               | Efficiency  | 93 %               |
| LED             | XT-E                     | cd/lm   | 0.490              |
| Color           | Clear                    | Gerber File   | Available          |
| Diameter        | 50x50 mm                 | <a href="http://oemwebshop.philips.com/fortimo-fastflex-led-board-2x8-740-da-g3.html">http://oemwebshop.philips.com/fortimo-fastflex-led-board-2x8-740-da-g3.html</a> |                    |
| Height          | 6 mm                     |   |                    |
| Style           | Square                   |   |                    |
| Optic Material  | PMMA                     |   |                    |
| Holder Material | -                        |   |                    |
| Fastening       | ["glue", "pin", "screw"] |   |                    |
| Status          | Production ready         |   |                    |

**Product number C12419\_STRADA-2X2-A-T**

|                 |                          |   |                    |
|-----------------|--------------------------|---|--------------------|
| Family          | Strada-Module            | FWHM  | Asymmetric degrees |
| Type            | Lens array               | Efficiency  | 93 %               |
| LED             | XT-E                     | cd/lm   | 0.470              |
| Color           | Clear                    | Gerber File   | Available          |
| Diameter        | 50x50 mm                 | <a href="http://oemwebshop.philips.com/fortimo-fastflex-led-board-2x8-740-da-g3.html">http://oemwebshop.philips.com/fortimo-fastflex-led-board-2x8-740-da-g3.html</a> |                    |
| Height          | 7.3 mm                   |   |                    |
| Style           | Rectang                  |   |                    |
| Optic Material  | PMMA                     |   |                    |
| Holder Material | -                        |   |                    |
| Fastening       | ["glue", "screw", "pin"] |   |                    |
| Status          | Production ready         |   |                    |

**Product number C13299\_STRADA-2X2-ME**

|                 |                          |  |                    |
|-----------------|--------------------------|--|--------------------|
| Family          | Strada-Module            | FWHM   | Asymmetric degrees |
| Type            | Lens array               | Efficiency   | 94 %               |
| LED             | XT-E                     | cd/lm  | 1.000              |
| Color           | Clear                    | Gerber File  | Available          |
| Diameter        | 50 + 50 mm               | Designed for European ME road lighting classes.        |                    |
| Height          | 7.1 mm                   | Optimized for luminaires using transparent flat cover. |                    |
| Style           | Square                   |  |                    |
| Optic Material  | PMMA                     |  |                    |
| Holder Material | -                        |  |                    |
| Fastening       | ["glue", "pin", "screw"] |  |                    |
| Status          | Production ready         |  |                    |

**Product number C13300\_STRADA-2X2-T2**

|                 |                          |
|-----------------|--------------------------|
| Family          | Strada-Module            |
| Type            | Lens array               |
| LED             | XT-E                     |
| Color           | Clear                    |
| Diameter        | 50 + 50 mm               |
| Height          | 7.7 mm                   |
| Style           | Square                   |
| Optic Material  | PMMA                     |
| Holder Material | -                        |
| Fastening       | ["glue", "pin", "screw"] |
| Status          | Production ready         |

|             |                    |
|-------------|--------------------|
| FWHM        | Asymmetric degrees |
| Efficiency  | 93 %               |
| cd/lm       | -                  |
| Gerber File | Available          |

IESNA Type II Street light optic

Suitable for narrow roads and pedestrian pathways.

**Product number C13301\_STRADA-2X2-T3**

|                 |                          |
|-----------------|--------------------------|
| Family          | Strada-Module            |
| Type            | Lens array               |
| LED             | XT-E                     |
| Color           | Clear                    |
| Diameter        | 50 x 50 mm               |
| Height          | 7.1 mm                   |
| Style           | Square                   |
| Optic Material  | PMMA                     |
| Holder Material | -                        |
| Fastening       | ["pin", "screw", "glue"] |
| Status          | Production ready         |

|             |                    |
|-------------|--------------------|
| FWHM        | Asymmetric degrees |
| Efficiency  | 94 %               |
| cd/lm       | 0.730              |
| Gerber File | Available          |

IESNA Type III Street light optic

**Product number C13699\_STRADA-2X2-DN**

|                 |                  |
|-----------------|------------------|
| Family          | Strada-Module    |
| Type            | Lens array       |
| LED             | XT-E             |
| Color           | Clear            |
| Diameter        | 50 x 50 mm       |
| Height          | 8.05 mm          |
| Style           | Square           |
| Optic Material  | PMMA             |
| Holder Material | -                |
| Fastening       | ["pin", "screw"] |
| Status          | Production ready |

|             |                    |
|-------------|--------------------|
| FWHM        | asymmetric degrees |
| Efficiency  | 94 %               |
| cd/lm       | 0.670              |
| Gerber File | Available          |

**Product number C13805\_STRADA-2X2-T4**

|                 |                  |
|-----------------|------------------|
| Family          | Strada-Module    |
| Type            | Lens             |
| LED             | XT-E             |
| Color           | Clear            |
| Diameter        | 50x50 mm         |
| Height          | 7.7 mm           |
| Style           | Square           |
| Optic Material  | PMMA             |
| Holder Material | -                |
| Fastening       | ["pin", "screw"] |
| Status          | Production ready |

|             |                    |
|-------------|--------------------|
| FWHM        | Asymmetric degrees |
| Efficiency  | 94 %               |
| cd/lm       | 0.500              |
| Gerber File | Available          |

<http://oemwebshop.philips.com/fortimo-fastflex-led-board-2x8-740-da-g3.html>

**Product number C13858\_STRADA-2X2-XW**

|                 |                          |  |                    |
|-----------------|--------------------------|--|--------------------|
| Family          | Strada-Module            | FWHM   | Asymmetric degrees |
| Type            | Lens                     | Efficiency                                       | 93 %               |
| LED             | XT-E                     | cd/lm  | 0.850              |
| Color           | Clear                    | Gerber File                                      | Available          |
| Diameter        | 50x50 mm                 | Extra wide beam for wide area security lighting. |                    |
| Height          | 7.1 mm                   |  |                    |
| Style           | Rectang                  |  |                    |
| Optic Material  | PMMA                     |  |                    |
| Holder Material | -                        |  |                    |
| Fastening       | ["glue", "pin", "screw"] |  |                    |
| Status          | Production ready         |  |                    |

**Product number C14116\_STRADA-2X2-PX**

|                 |                  |  |                    |
|-----------------|------------------|--|--------------------|
| Family          | Strada-Module    | FWHM   | Asymmetric degrees |
| Type            | Lens             | Efficiency   | 94 %               |
| LED             | XT-E             | cd/lm  | 0.950              |
| Color           | Clear            | Gerber File  | Available          |
| Diameter        | 50x50 mm         | Double assymmetric beam designed for pedestrian crossings. |                    |
| Height          | 8 mm             |  |                    |
| Style           | Square           |  |                    |
| Optic Material  | PMMA             |  |                    |
| Holder Material | -                |  |                    |
| Fastening       | ["screw", "pin"] |  |                    |
| Status          | Production ready |  |                    |

**Product number C13499\_STRADA-2X2-CY**

|                 |                  |   |                 |
|-----------------|------------------|---|-----------------|
| Family          | Strada-Module    | FWHM  | 136+136 degrees |
| Type            | Lens array       | Efficiency  | 94 %            |
| LED             | XT-E             | cd/lm   | 0.300           |
| Color           | Clear            | Gerber File   | Available       |
| Diameter        | 50x50 mm         | <a href="http://oemwebshop.philips.com/fortimo-fastflex-led-board-2x8-740-da-g3.html">http://oemwebshop.philips.com/fortimo-fastflex-led-board-2x8-740-da-g3.html</a> |                 |
| Height          | 7.85 mm          |   |                 |
| Style           | Square           |   |                 |
| Optic Material  | PMMA             |   |                 |
| Holder Material | -                |   |                 |
| Fastening       | ["screw"]        |   |                 |
| Status          | Production ready |   |                 |

**Product number C14680\_STRADA-2X2-VSM**

|                 |                          |   |             |
|-----------------|--------------------------|---|-------------|
| Family          | Strada-Module            | FWHM  | 152 degrees |
| Type            | Lens                     | Efficiency                                    | 94 %        |
| LED             | XT-E                     | cd/lm   | 0.500       |
| Color           | Clear                    | Gerber File                                   | Available   |
| Diameter        | 50 x 50 mm               | Symmetrical wide square beam. (IESNA Type VS) |             |
| Height          | 6.14 mm                  |   |             |
| Style           | Square                   |   |             |
| Optic Material  | PMMA                     |   |             |
| Holder Material | -                        |   |             |
| Fastening       | ["screw", "glue", "pin"] |   |             |
| Status          | Production ready         |   |             |





## PRODUCT DATASHEET Strada-Module series

last update 21/4/2016

**NOTE: The typical divergence will be changed by different color, chip size and chip position tolerance. The typical total divergence is the full angle measured where the luminous intensity is half of the peak value.**



## PRODUCT DATASHEET Strada-Module series

last update 21/4/2016

### GENERAL INFORMATION

- Product series especially designed & optimized for XT-E series of LEDs.
- Special care taken to make light distribution as uniform as possible.
- Lens material optical grade PMMA with high UV and temperature resistance. Allows use of high current and temperature conditions.

Please find more information about used material from below:

[http://ledil.fi/sites/default/files/Documents/Technical/Material/PMMA%20N%20UL94\\_Yellow%20Card.pdf](http://ledil.fi/sites/default/files/Documents/Technical/Material/PMMA%20N%20UL94_Yellow%20Card.pdf)

<http://ledil.fi/sites/default/files/Documents/Technical/Material/PMMA%20N%20PLEXIGLAS-Datasheet.pdf>

D C B A

4

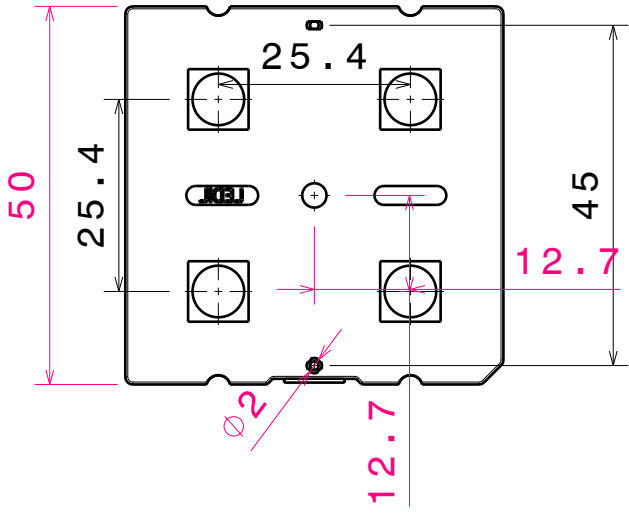

Bottom view

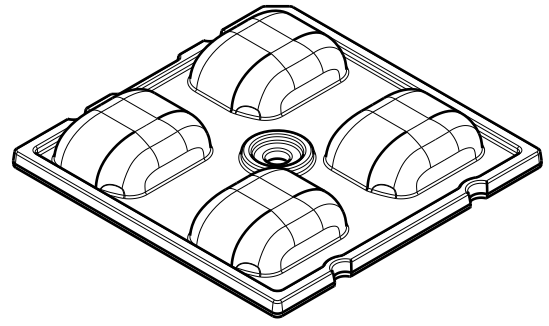

Isometric view

3

Beam Direction

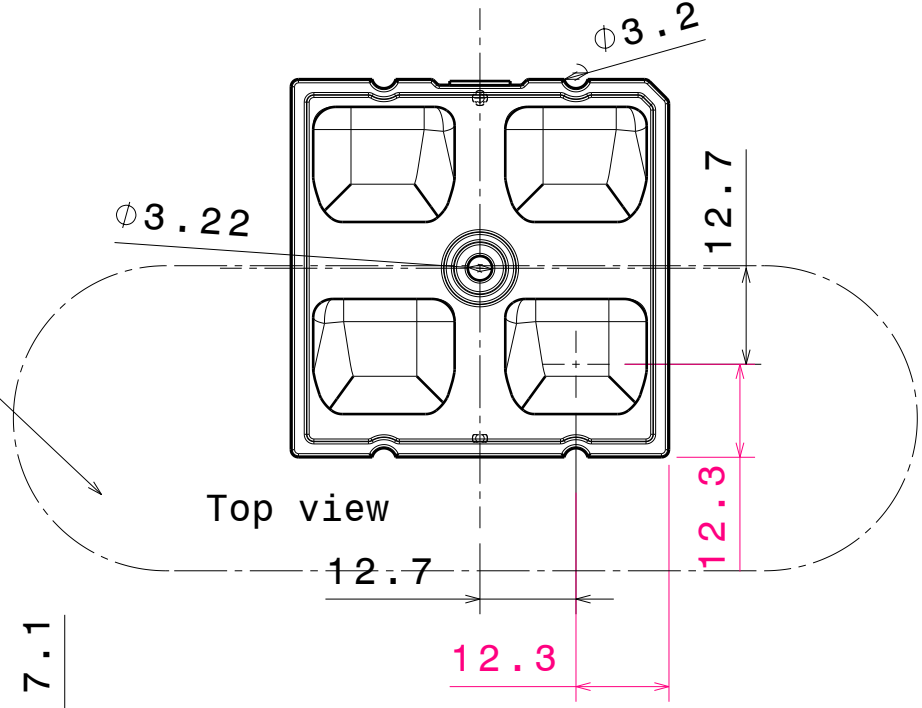

Top view

2

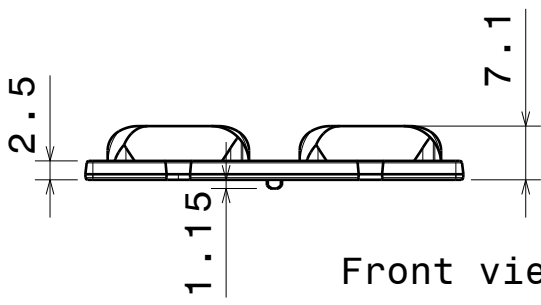

Front view

| INDEX | PART NO | DESCRIPTION   | MATERIAL | COLOUR      |
|-------|---------|---------------|----------|-------------|
| 1     | C13299  | STRADA-2X2-ME | PMMA 8N  | TRANSPARENT |

Tolerances if not otherwise shown  
According to DIN ISO 2768-1  
Linear measures:  
Up to 30mm class M, otherwise class C.  
According to DIN ISO 2768-2  
Form and position: class L

**LEDiL** LediL Oy  
Salorankatu 10  
FIN 24240 SALO  
Finland

THIRD ANGLE PROJECTION:

DRAWING TITLE  
**C13299\_STRADA-2X2-ME**

This drawing is the property of LEDiL Oy. It may not be reproduced, copied or communicated without a written agreement with LEDiL Oy."

| SIZE | PART NUMBER |
|------|-------------|
| A4   | C13299      |

| SCALE | 1:1 | WEIGHT | SHEET | 1/1 |
|-------|-----|--------|-------|-----|
|-------|-----|--------|-------|-----|

1

D A

Luminaire: Ledil Oy C13604\_STRADA-2X2-FN\_(XT-E)\_SIMULATED  
Lamps: 1 x Cree XT-E

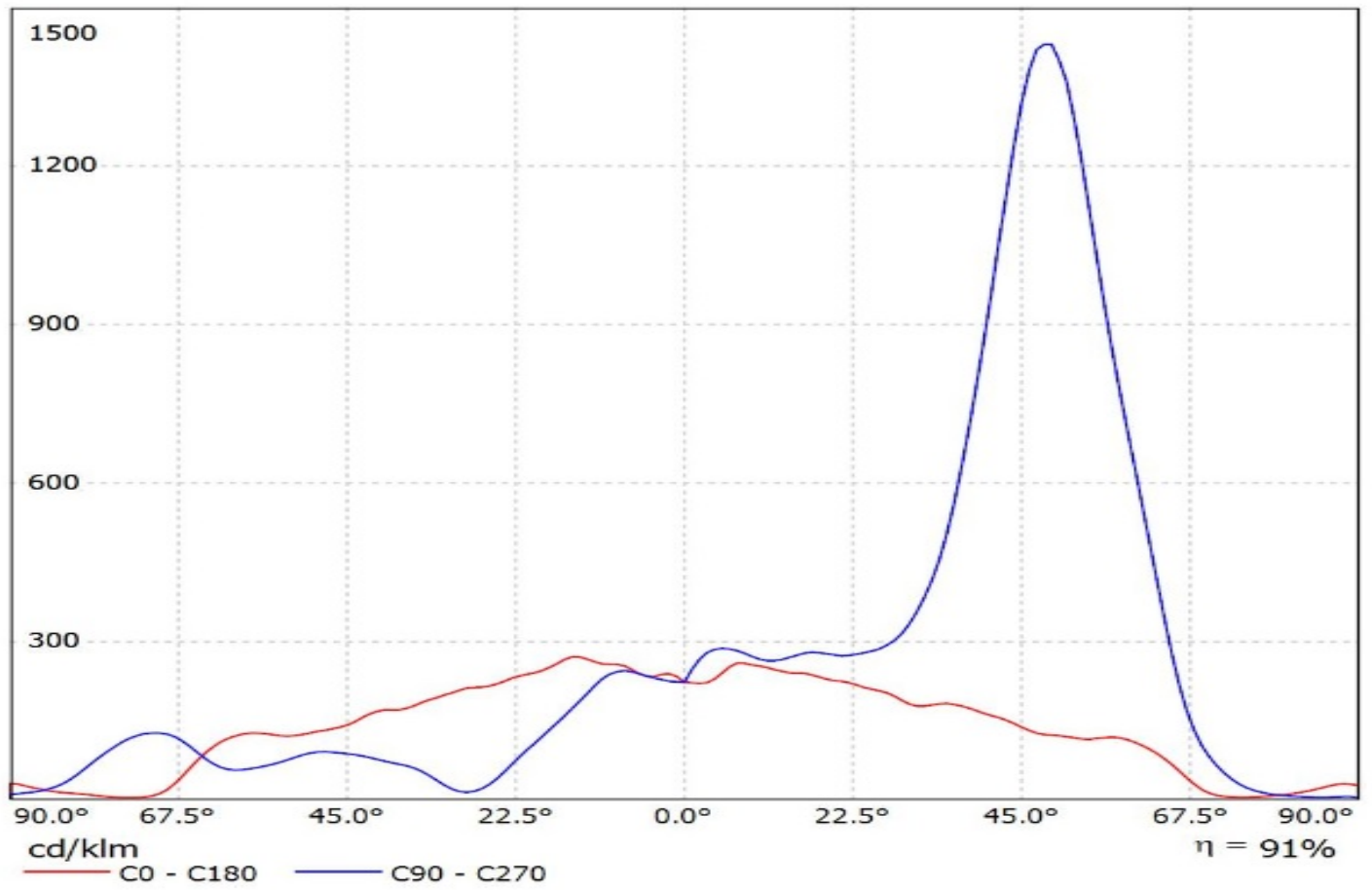



Luminaire: Ledil Oy C12360\_Strada-2x2-DNWW (XT-E) Efficiency=93%  
Lamps: 1 x Cree XT-E 250mA 409lm

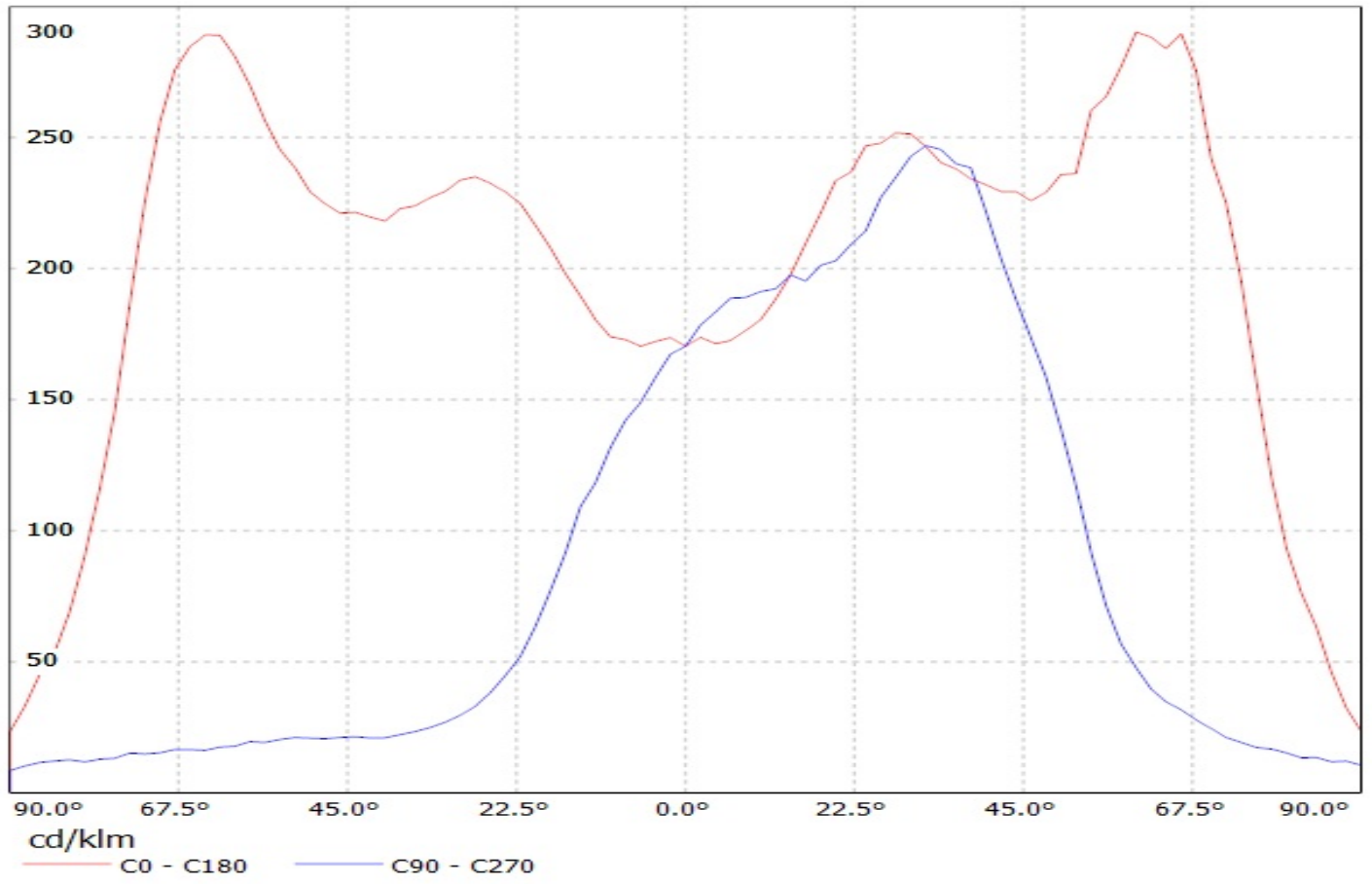

Luminaire: Ledil Oy C12362\_STRADA-2X2-DWC (Cree XT-E AWT 409lm @ 250mA)  
Lamps: 1 x Cree XT-E AWT 409lm @ 250mA

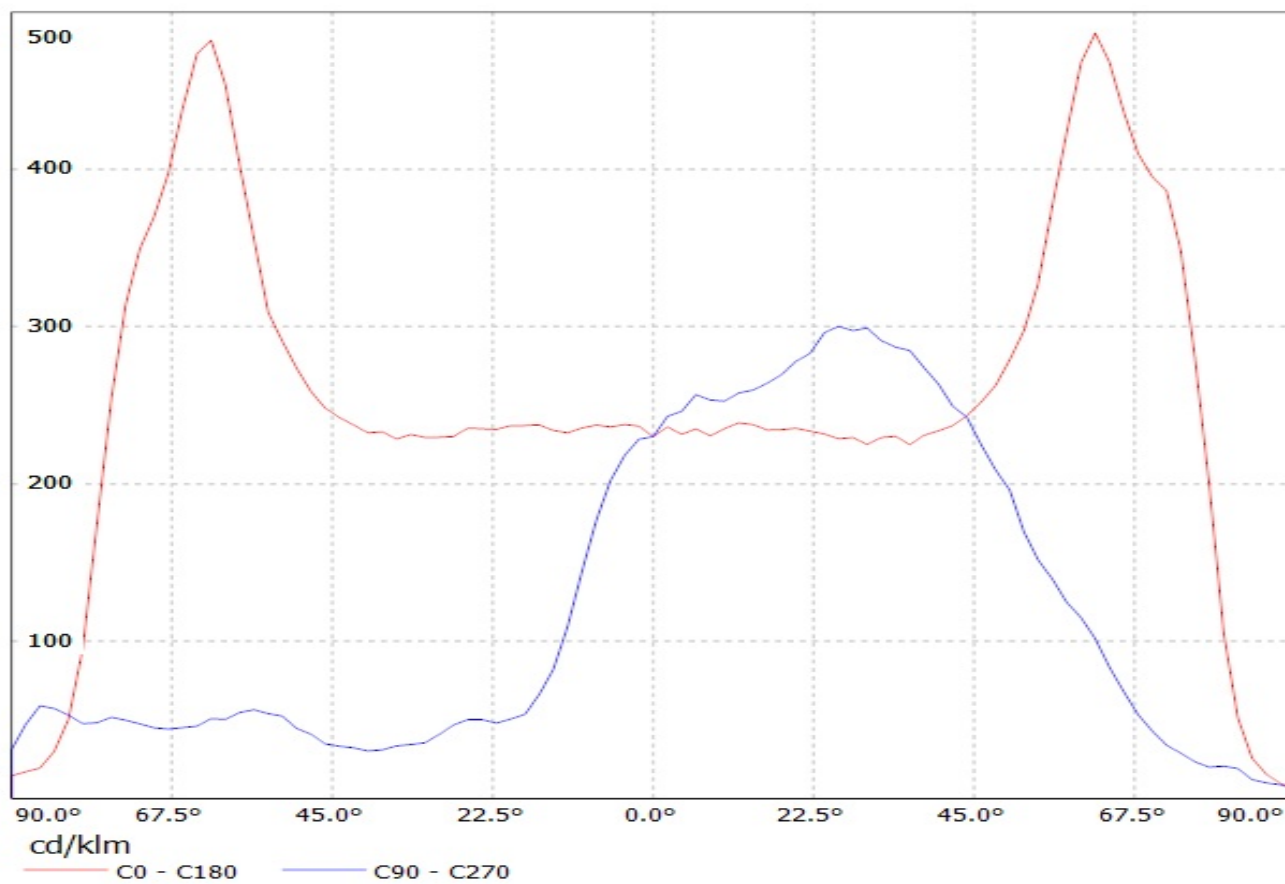

Luminaire: LEDiL Oy C13299\_STRADA-2X2-ME\_(XT-E)\_3 Eff.94.0%  
Lamps: 1 x CREE\_XT-E\_385.199lm@250mA\_CCT=5717K

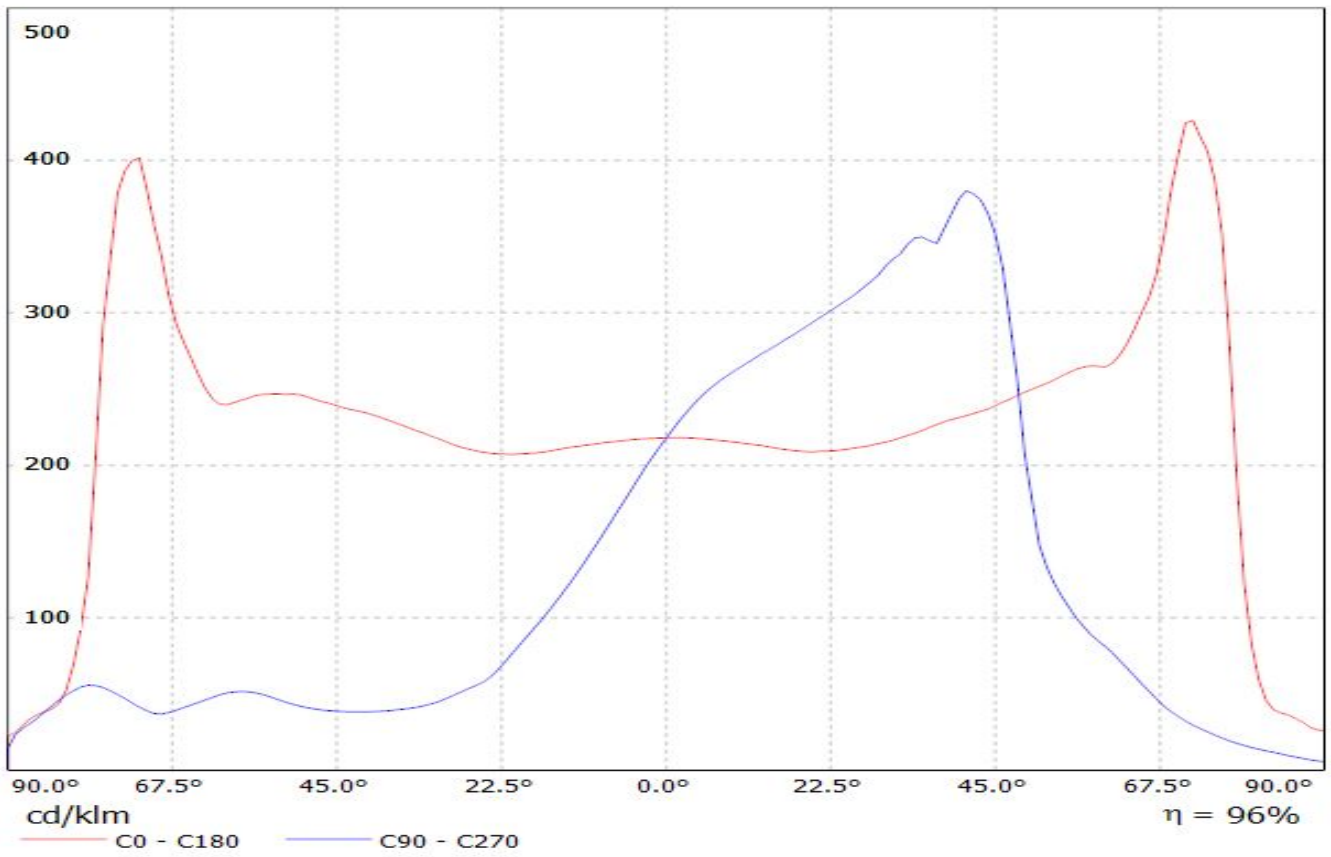

# LEDiL Oy C13301\_STRADA-2X2-T3\_(XT-E) 95.0% / LDC (Linear)

Luminaire: LEDiL Oy C13301\_STRADA-2X2-T3\_(XT-E) 95.0%  
Lamps: 1 x CREE\_XT-E (390lm@250mA)

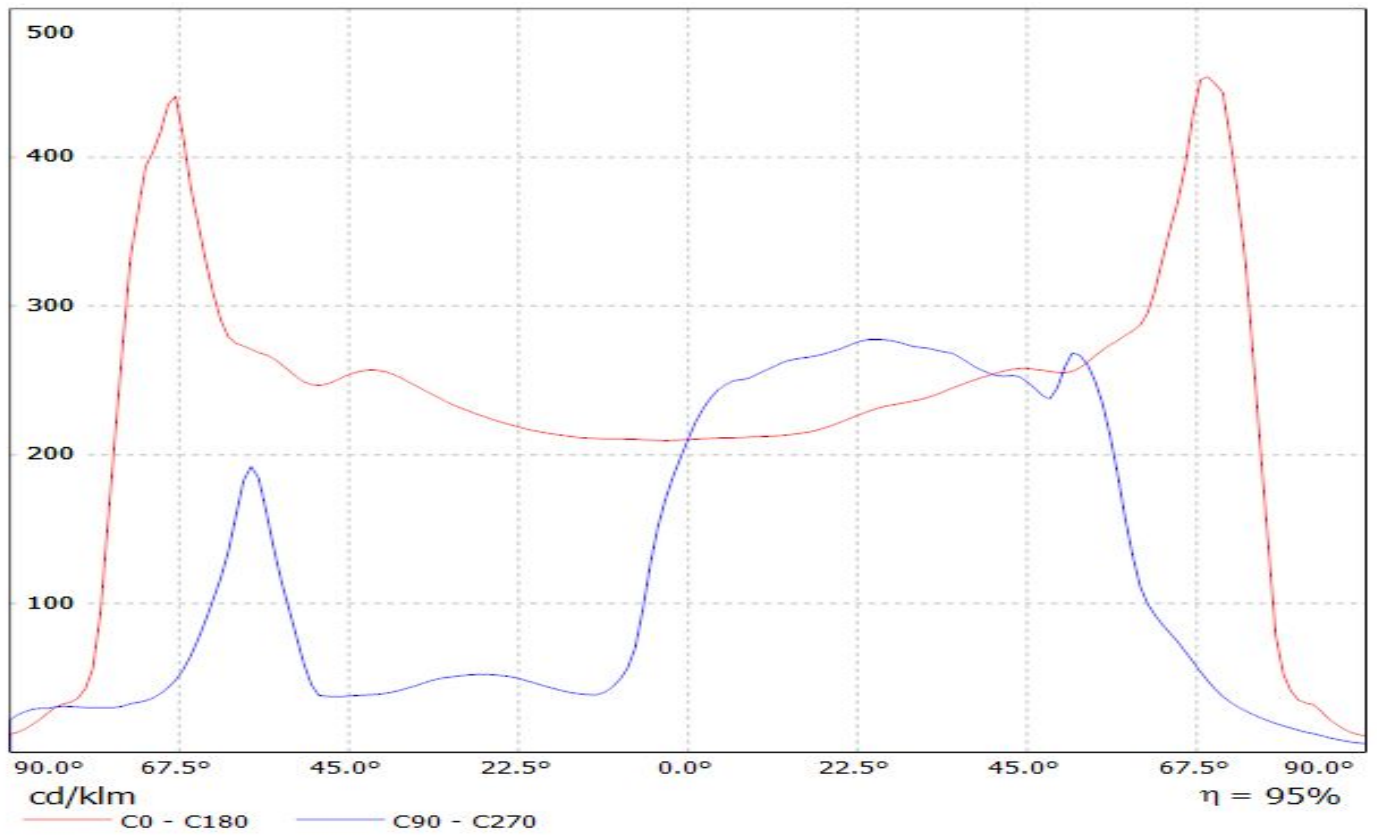

Luminaire: LEDiL Oy C13699\_STRADA-2x2-DN\_(XT-E) Eff. 94%  
Lamps: 1 x CREE\_XT-E\_2x2\_393lm@250mA

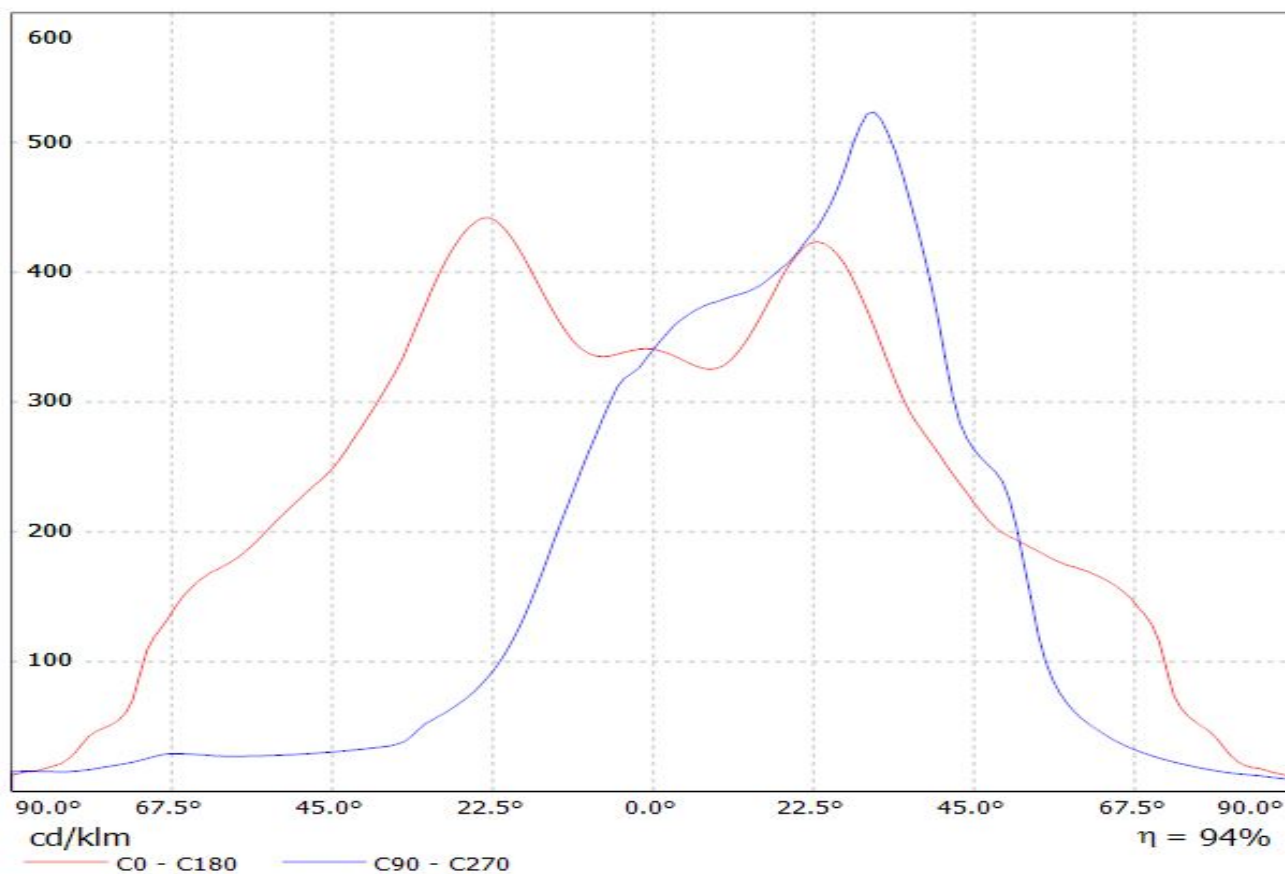

# LEDiL Oy C13805\_STRADA-2X2-T4\_(XT-E) Eff.94.0% / LDC (Linear)

Luminaire: LEDiL Oy C13805\_STRADA-2X2-T4\_(XT-E) Eff.94.0%

Lamps: 1 x CREE\_XT-E\_2x2\_381.369lm@250mA\_CCT=5717K\_P=2.9868W\_I=249.9mA

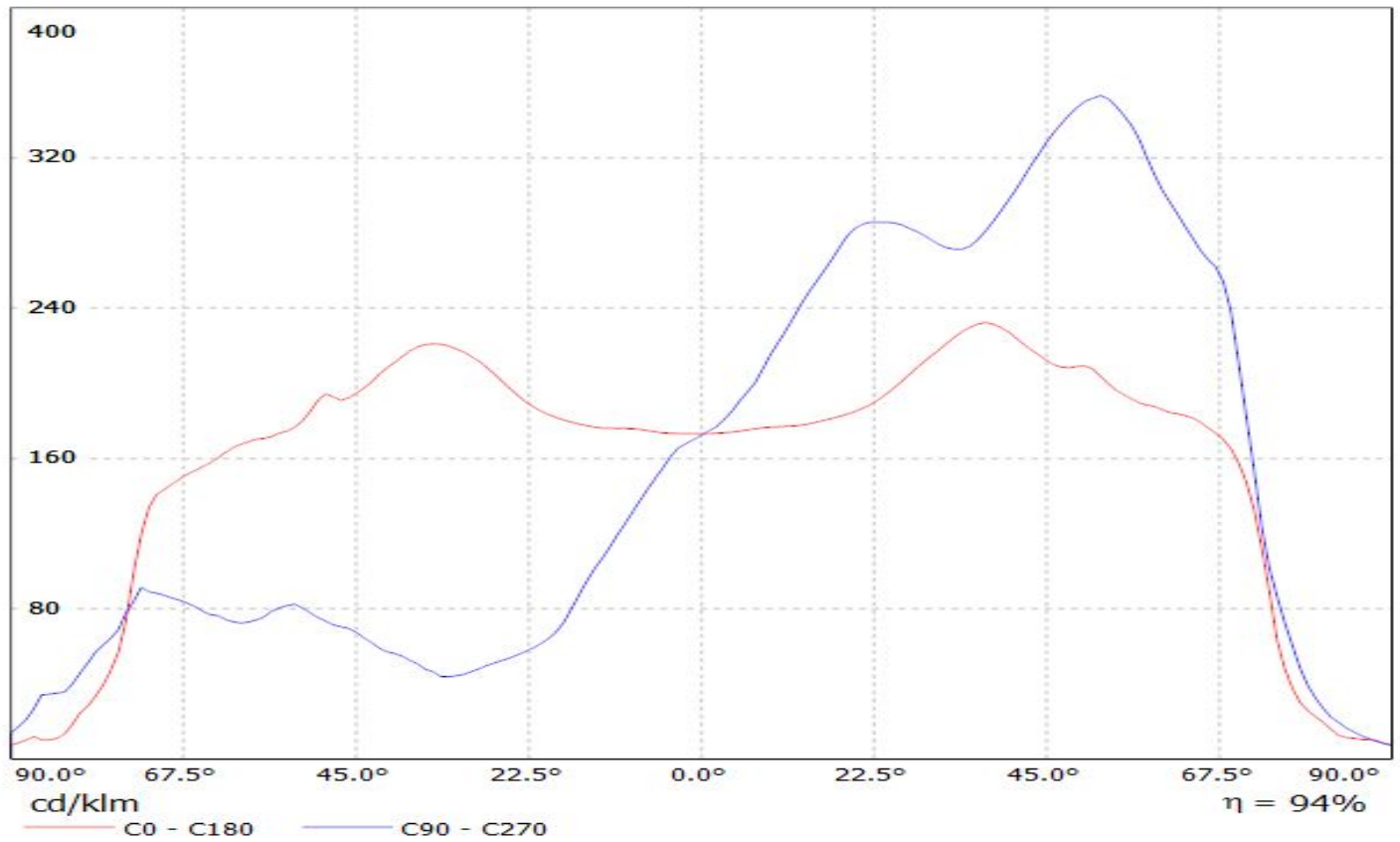



Luminaire: Ledil C13858\_STRADA\_2x2\_XW\_(XT-E)  
Lamps: 1 x XT-E\_429.235lm@250mA\_P=8W\_I=0.2499A

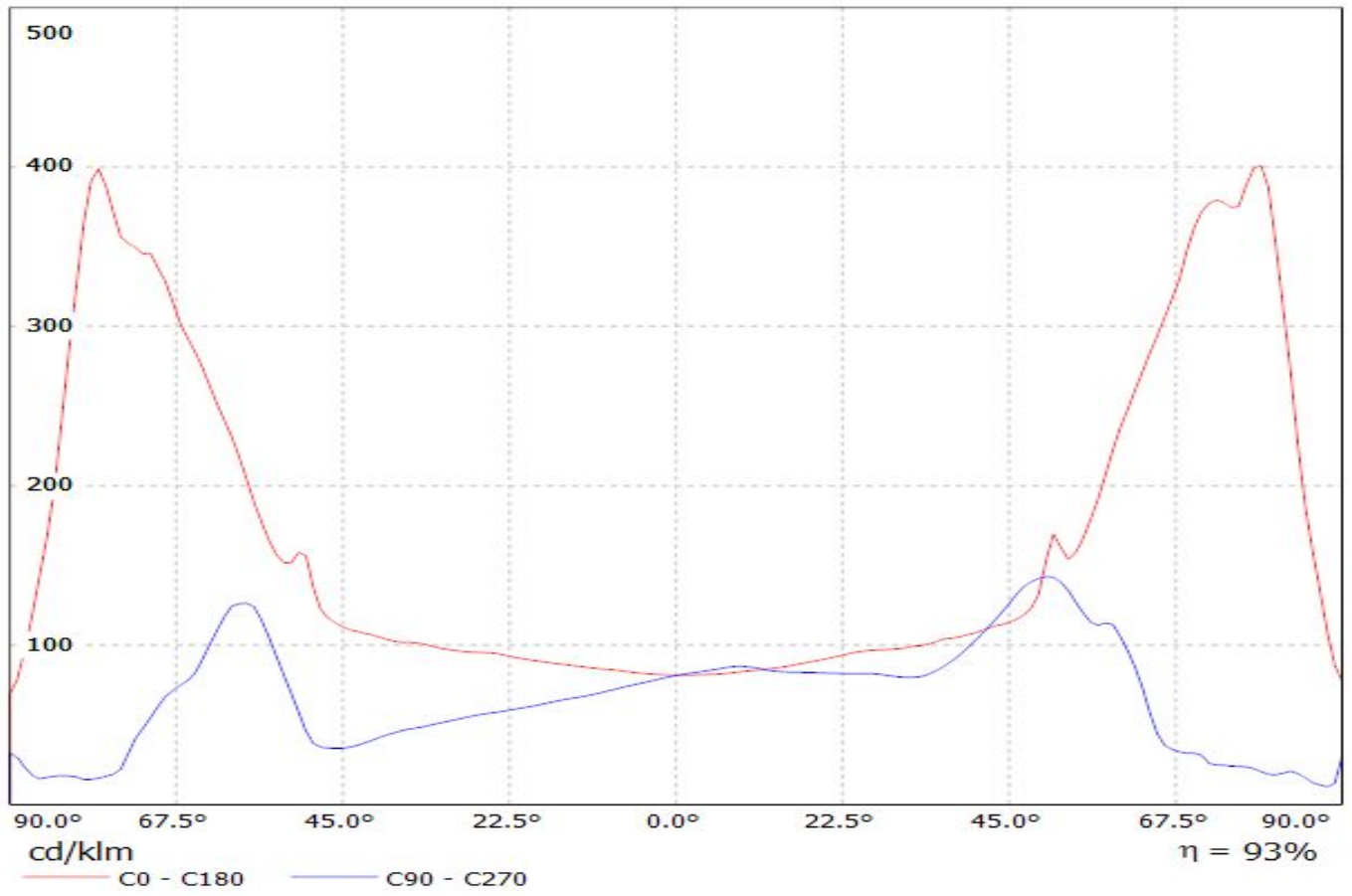

Luminaire: LEDiL Oy C14116\_STRADA-2X2-PX\_(XT-E)

Lamps: 1 x CREE\_XT-E\_2x2\_390.75lm@250mA\_CCT=5717K\_P=2.99855W\_I=249.9mA

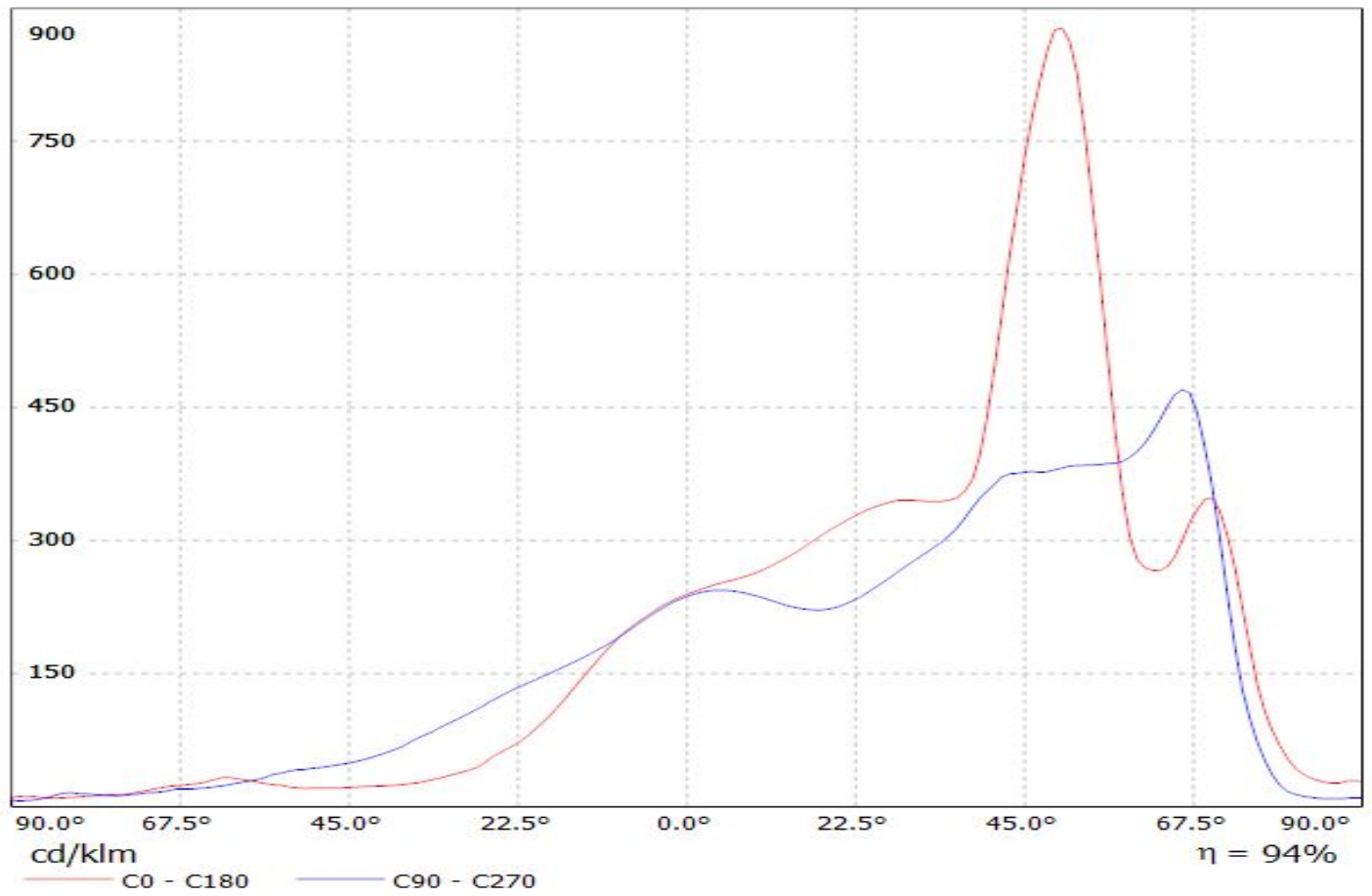

Luminaire: LEDiL Oy C13499\_STRADA-2X2-CY\_(XT-E) Eff.94%  
Lamps: 1 x CREE\_XT-E\_2x2\_393lm@250mA

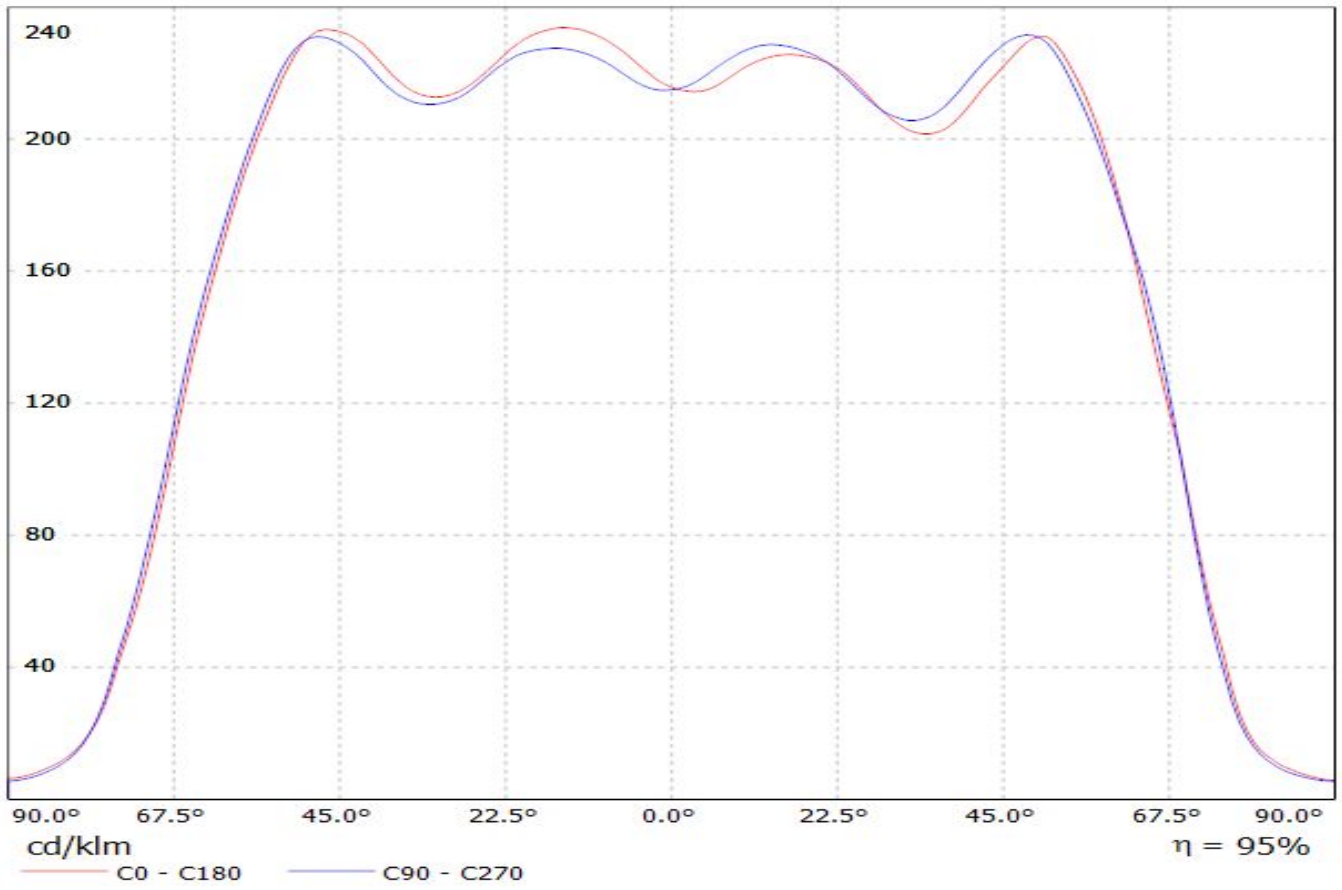

Luminaire: LEDiL Oy C14680\_STRADA-2X2-VSM\_(XT-E)  
Lamps: 1 x Cree\_XT-E\_(2x2)\_382.256lm@250mA\_P=2.98581W\_I=0.2499A

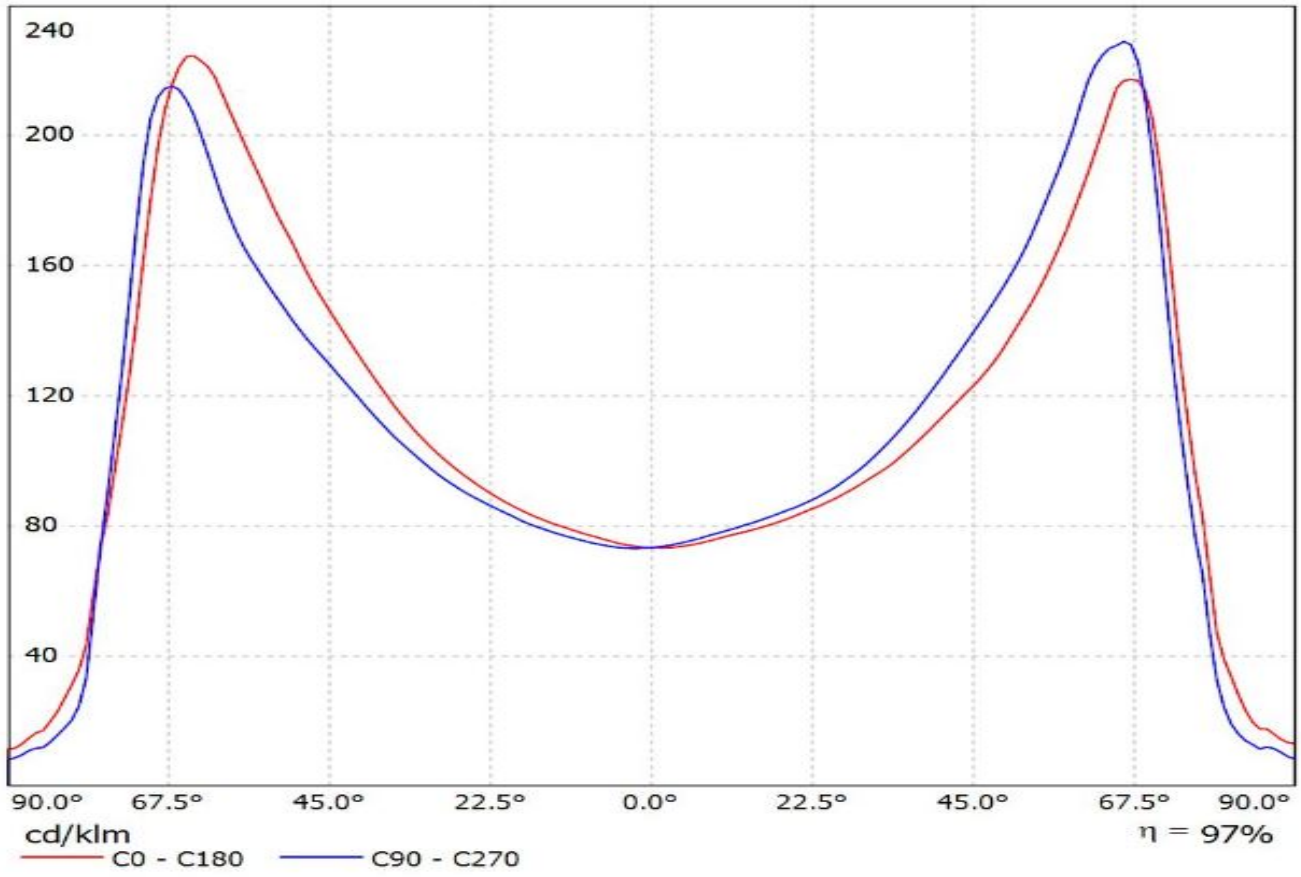

Luminaire: Ledil Oy C13604\_STRADA-2X2-FN\_(XT-E)\_SIMULATED  
Lamps: 1 x Cree XT-E

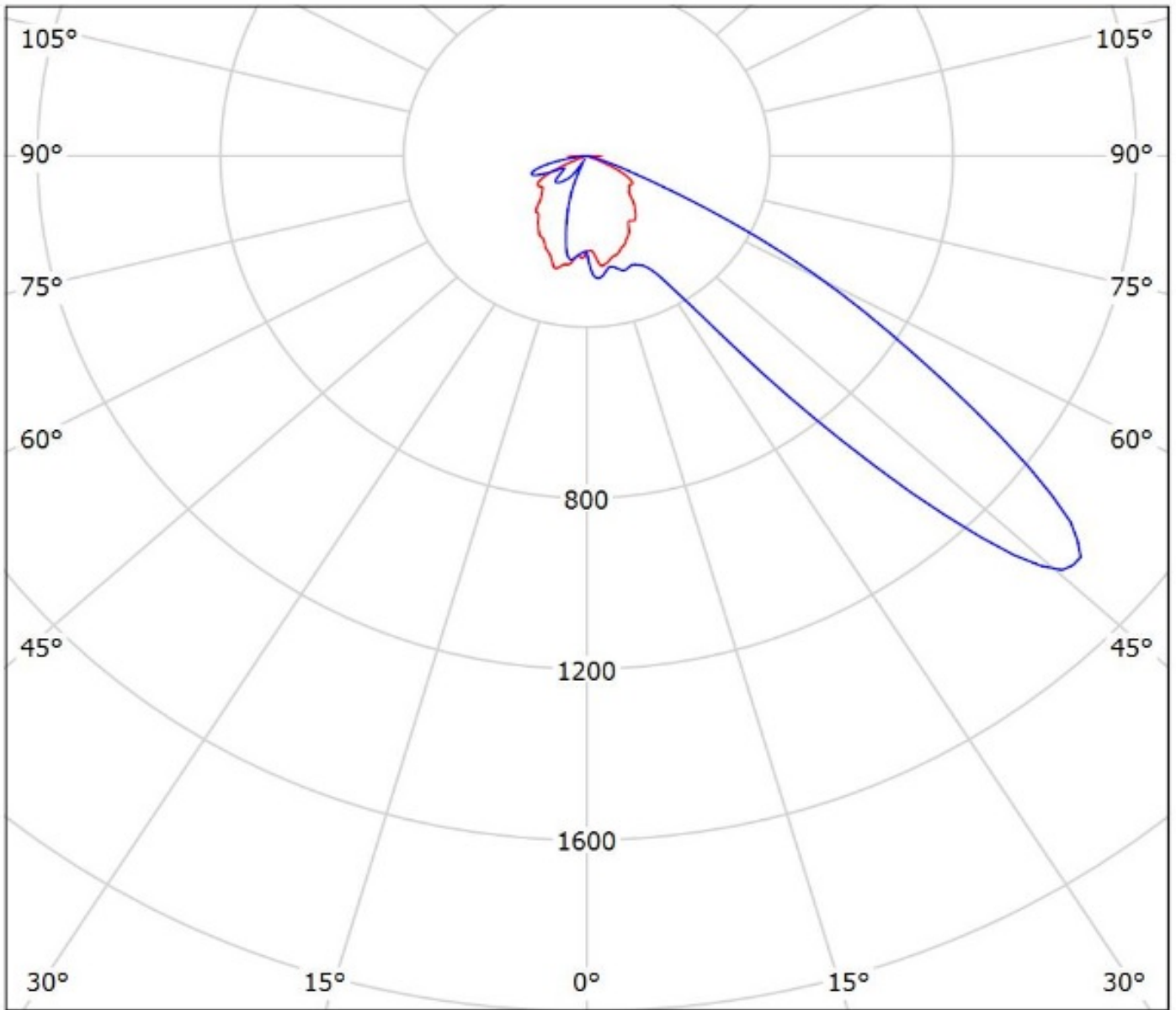

cd/klm

— C0 - C180 — C90 - C270

$\eta = 91\%$

Luminaire: Ledil Oy C15014\_STRADA-2X2-T4-B\_simulated\_XT-E  
Lamps: 1 x Cree XT-E

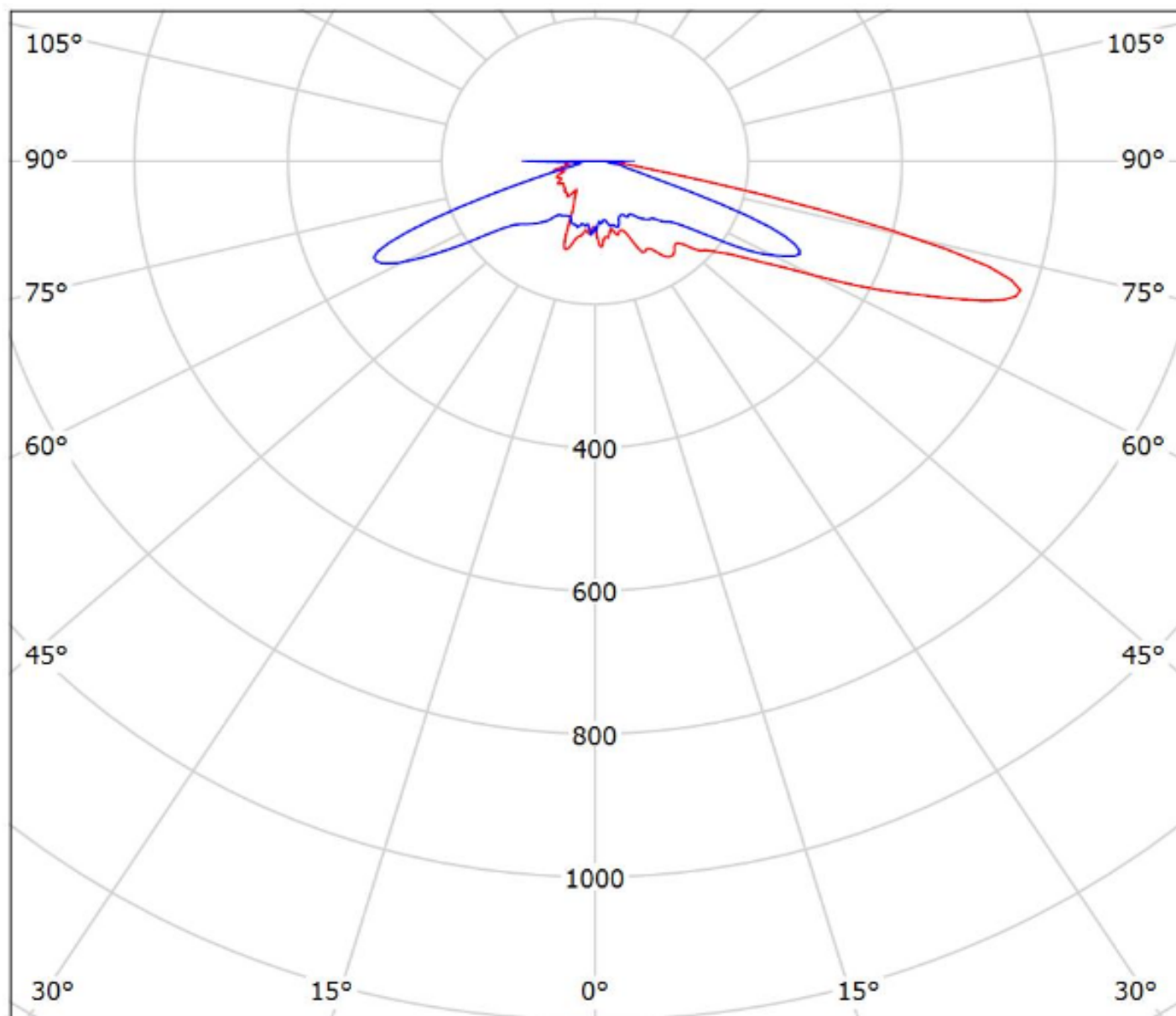

cd/klm

— C0 - C180 — C90 - C270

$\eta = 91\%$



Luminaire: Ledil Oy C12360\_Strada-2x2-DNW (XT-E) Efficiency=93%

Lamps: 1 x Cree XT-E 250mA 409lm

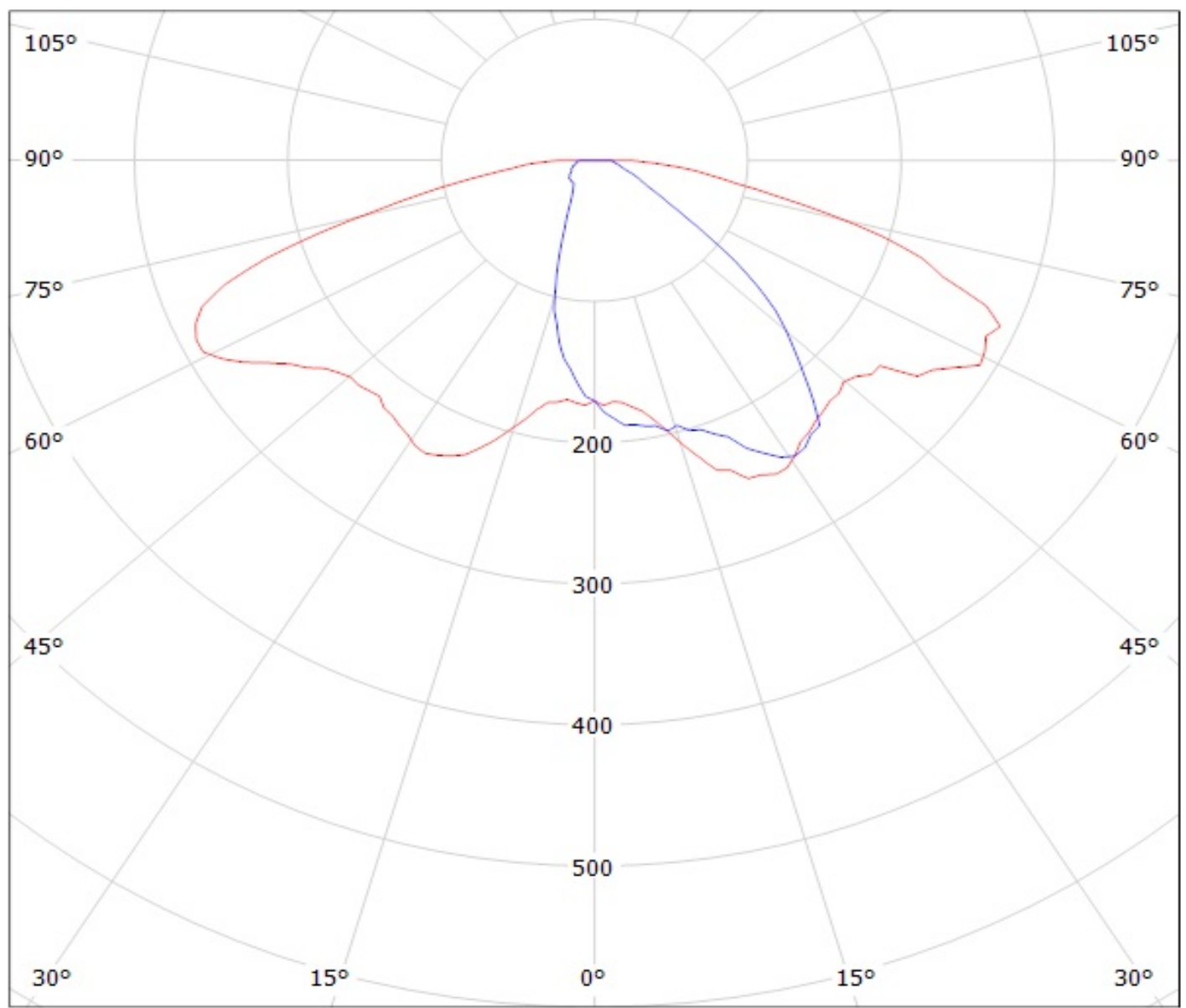

cd/klm

— C0 - C180    — C90 - C270

Luminaire: Ledil Oy C12362\_STRADA-2X2-DWC (Cree XT-E AWT 409lm @ 250mA)

Lamps: 1 x Cree XT-E AWT 409lm @ 250mA

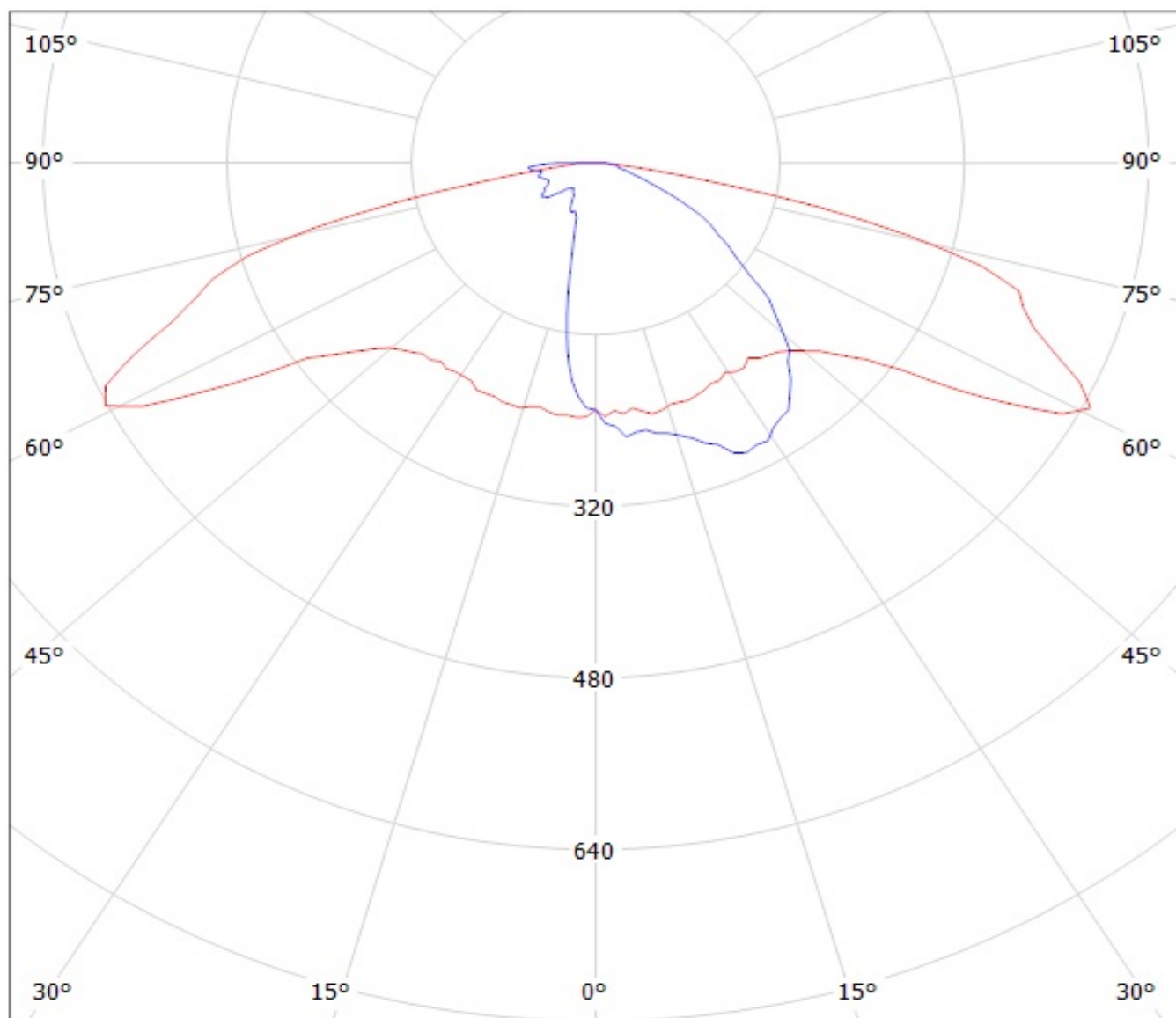

cd/klm

— C0 - C180

— C90 - C270

Luminaire: LEDiL Oy C13299\_STRADA-2X2-ME\_(XT-E)\_3 Eff.94.0%  
Lamps: 1 x CREE\_XT-E\_385.199lm@250mA\_CCT=5717K

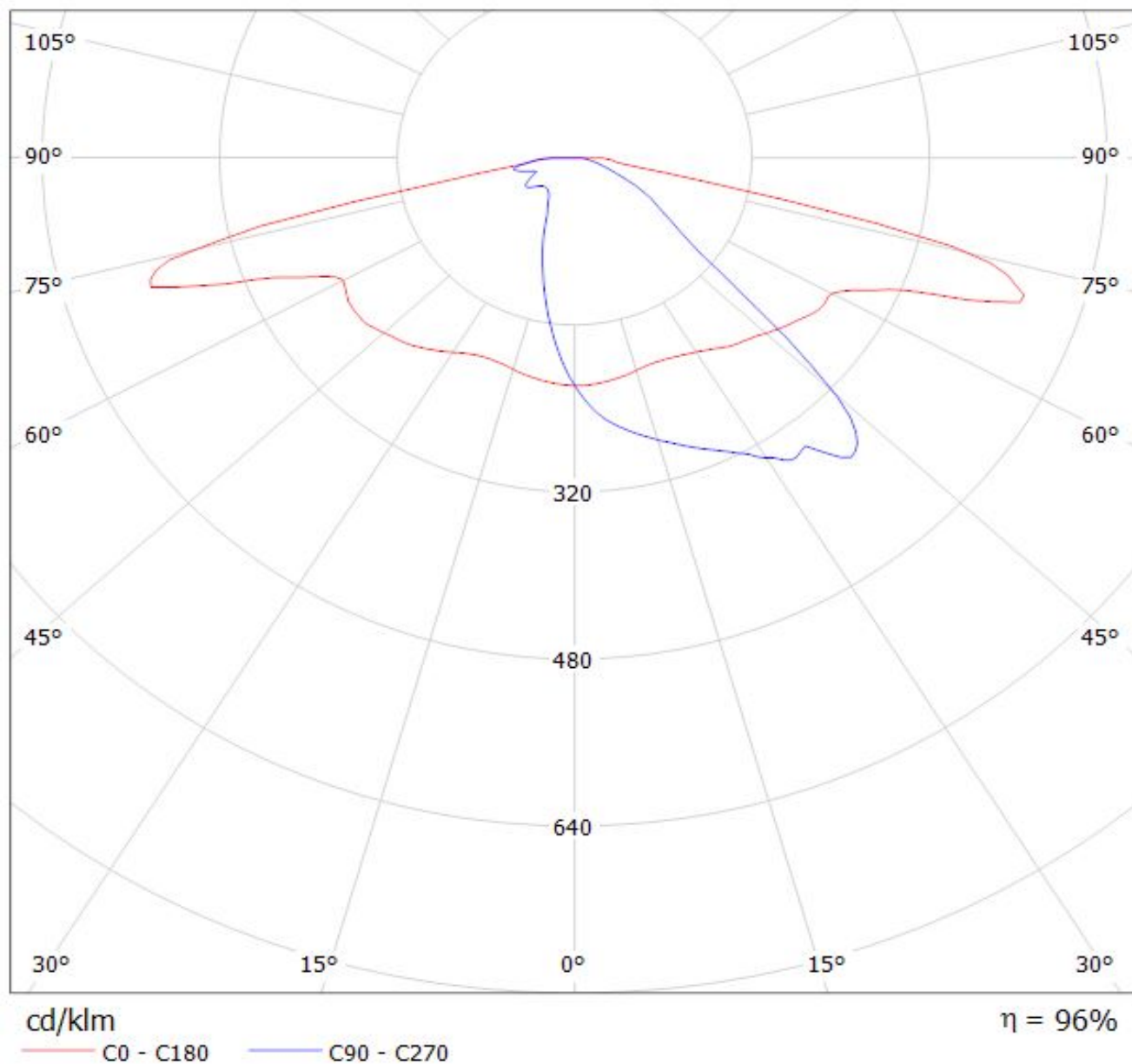

# LEDiL Oy C13301\_STRADA-2X2-T3\_(XT-E) 95.0% / LDC (Polar)

Luminaire: LEDiL Oy C13301\_STRADA-2X2-T3\_(XT-E) 95.0%

Lamps: 1 x CREE\_XT-E (390lm@250mA)

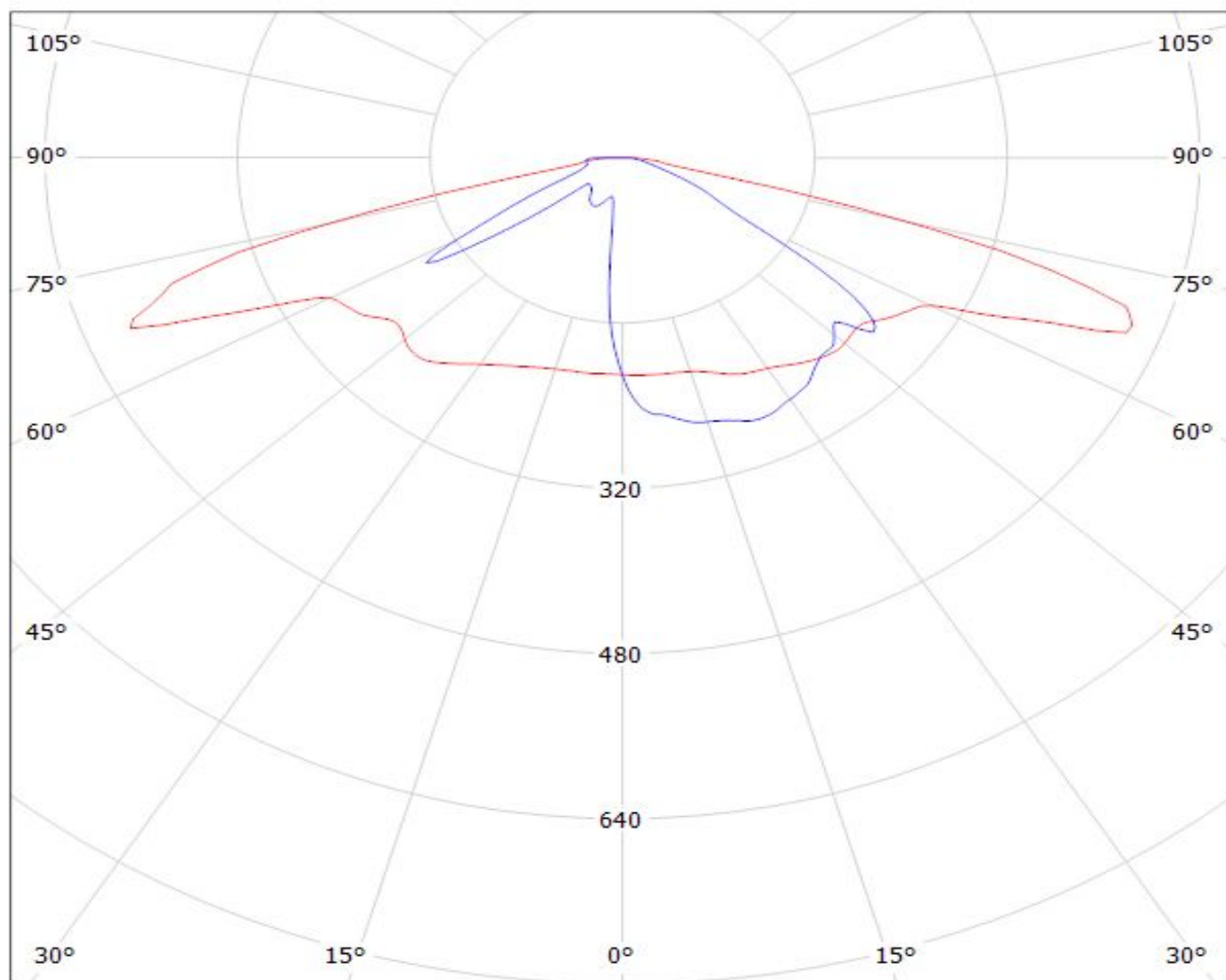

cd/klm

— C0 - C180

— C90 - C270

$\eta = 95\%$

Luminaire: LEDiL Oy C13699\_STRADA-2x2-DN\_(XT-E) Eff. 94%

Lamps: 1 x CREE\_XT-E\_2x2\_393lm@250mA

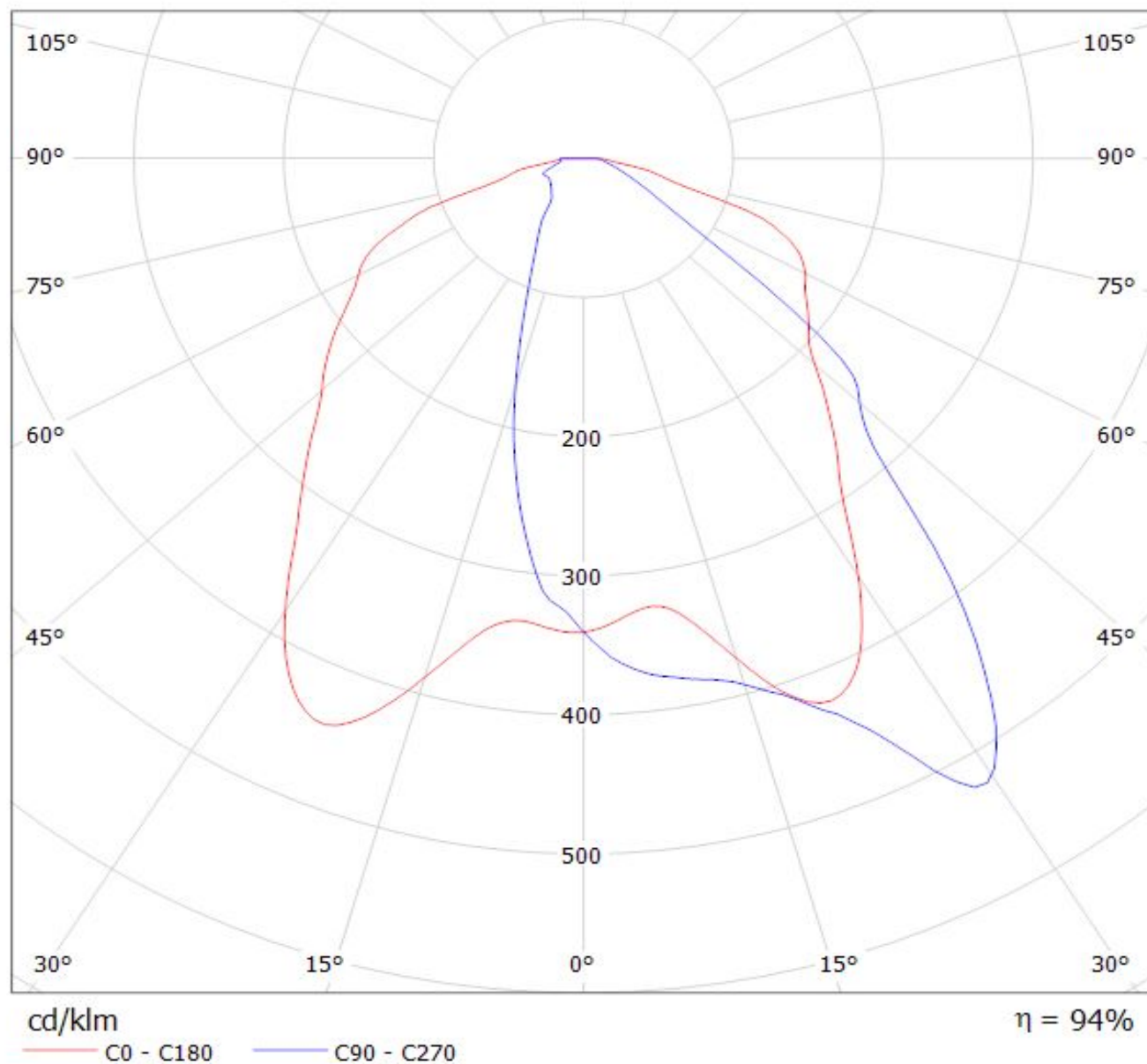

# LEDiL Oy C13805\_STRADA-2X2-T4\_(XT-E) Eff.94.0% / LDC (Polar)

Luminaire: LEDiL Oy C13805\_STRADA-2X2-T4\_(XT-E) Eff.94.0%

Lamps: 1 x CREE\_XT-E\_2x2\_381.369lm@250mA\_CCT=5717K\_P=2.9868W\_I=249.9mA

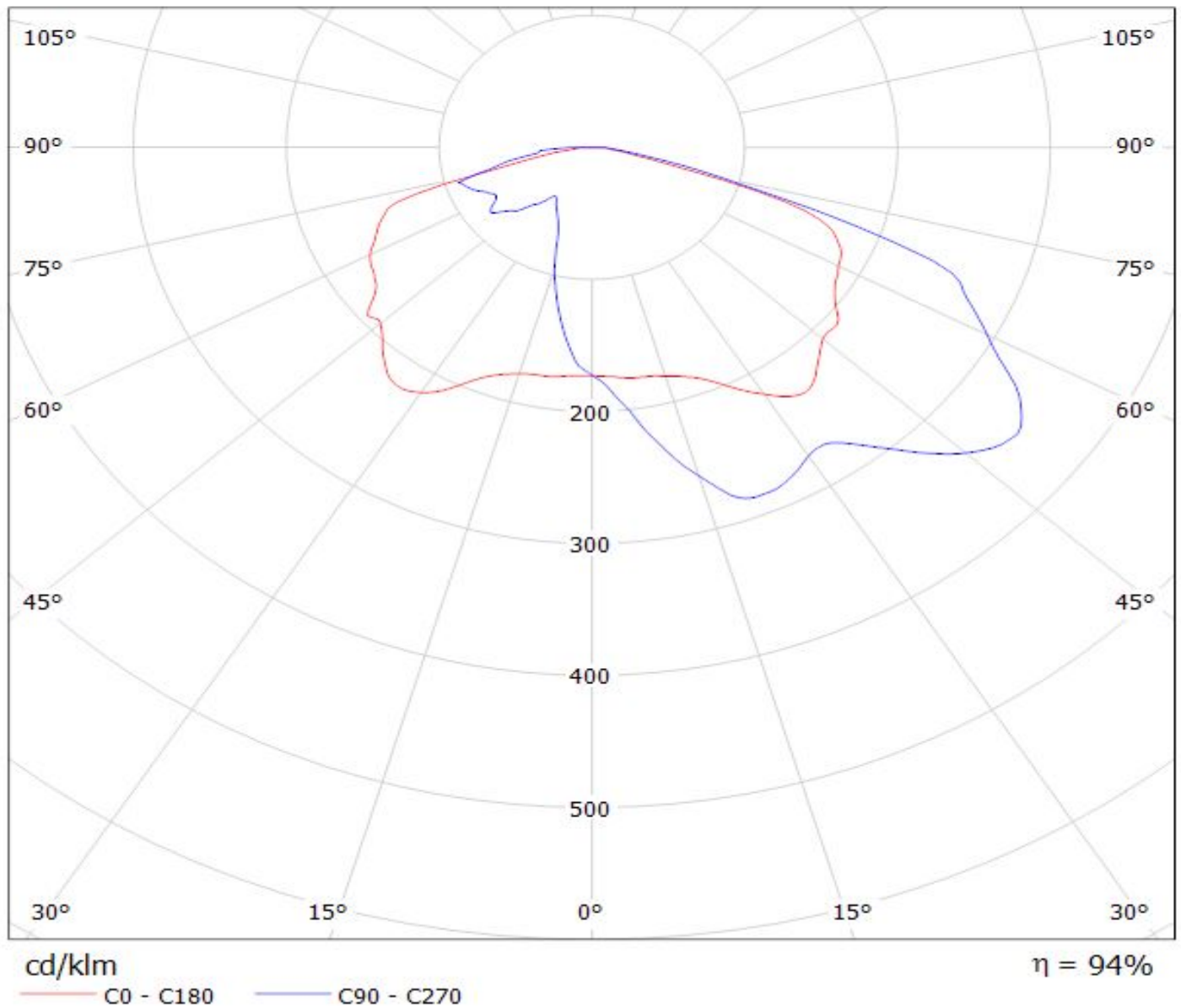



Luminaire: Ledil C13858\_STRADA\_2x2\_XW\_(XT-E)  
Lamps: 1 x XT-E\_429.235lm@250mA\_P=8W\_I=0.2499A

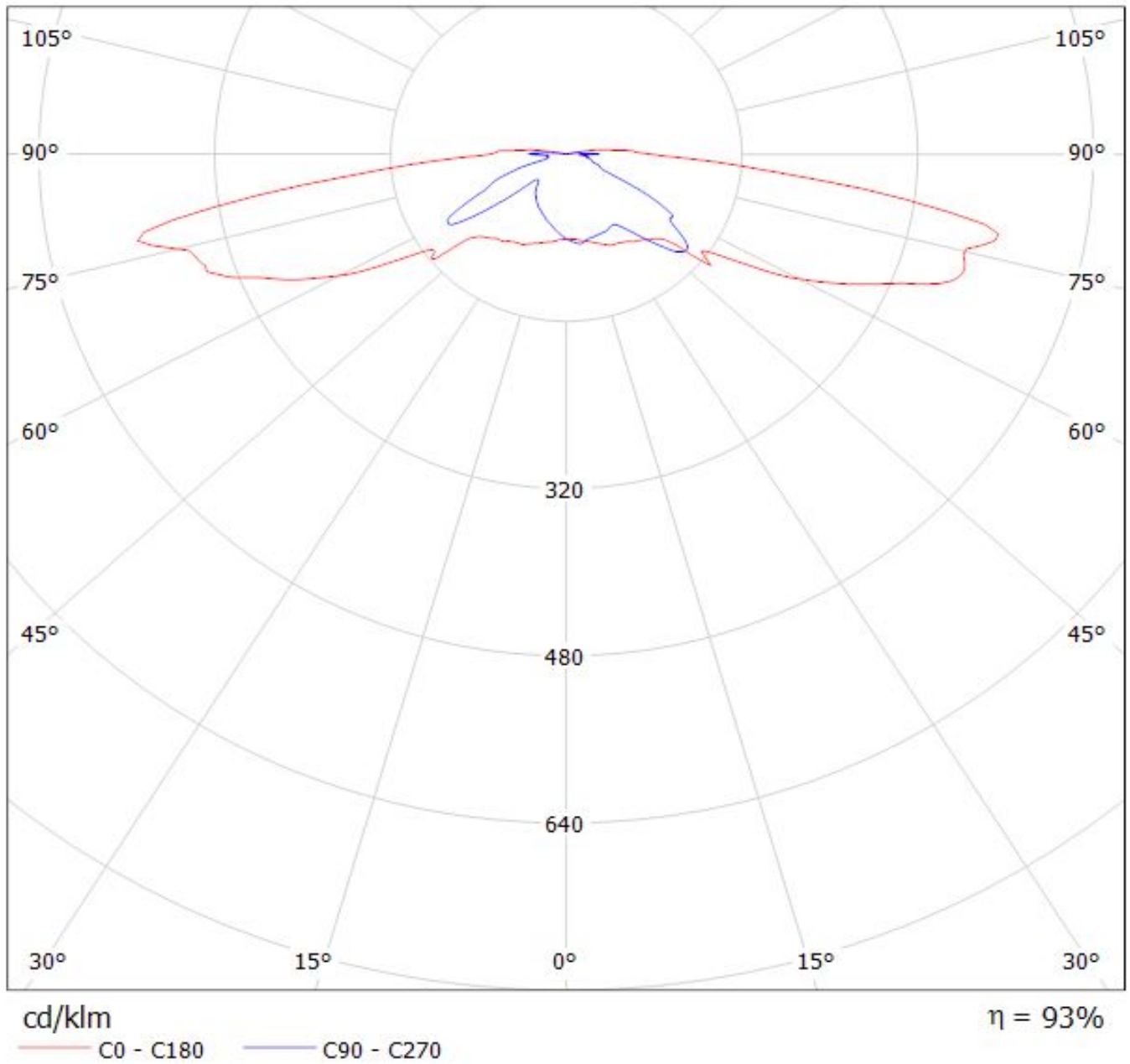

Luminaire: LEDiL Oy C14116\_STRADA-2X2-PX\_(XT-E)

Lamps: 1 x CREE\_XT-E\_2x2\_390.75lm@250mA\_CCT=5717K\_P=2.99855W\_I=249.9mA

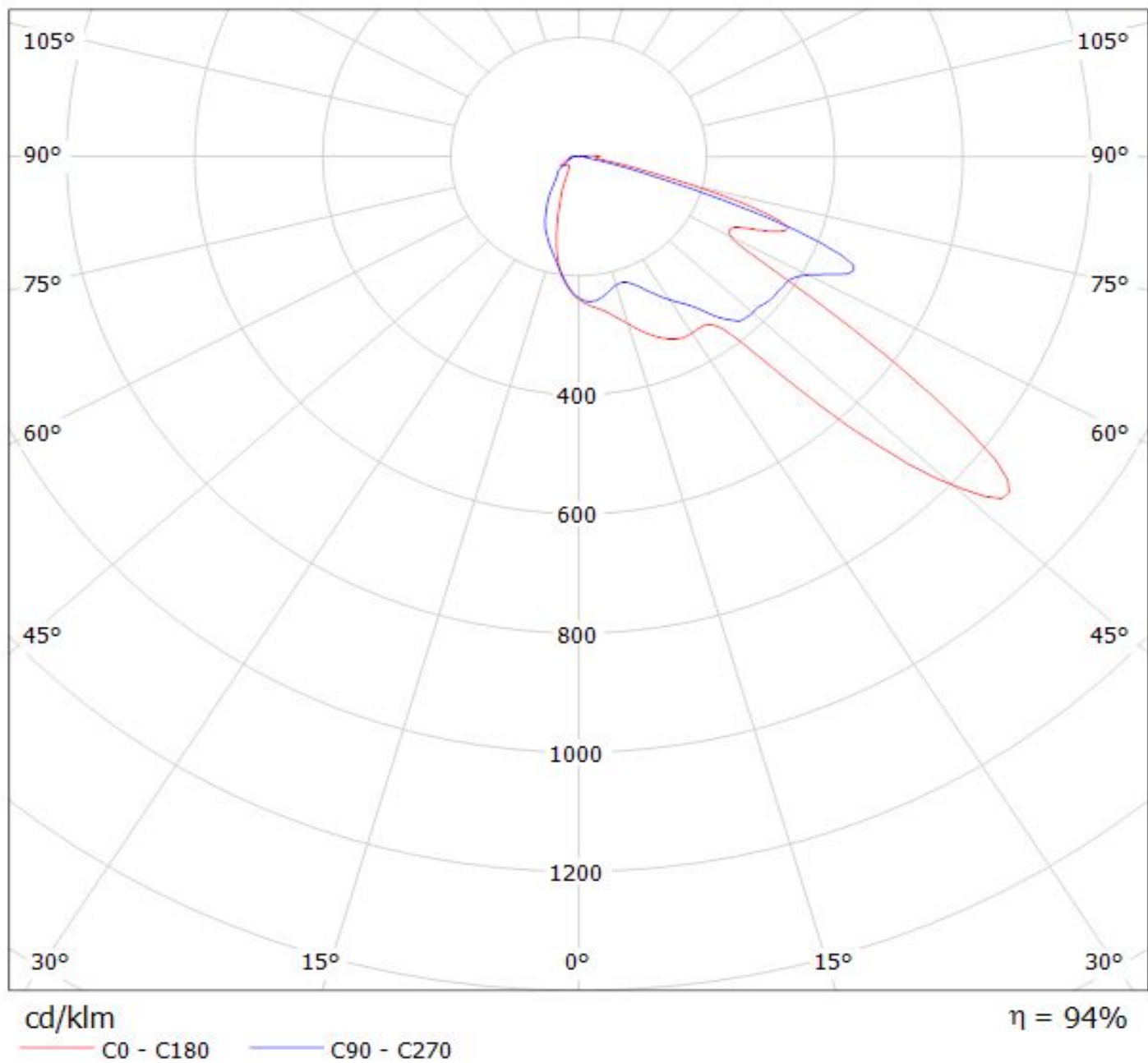

Luminaire: LEDiL Oy C13499\_STRADA-2X2-CY\_(XT-E) Eff.94%  
Lamps: 1 x CREE\_XT-E\_2x2\_393lm@250mA

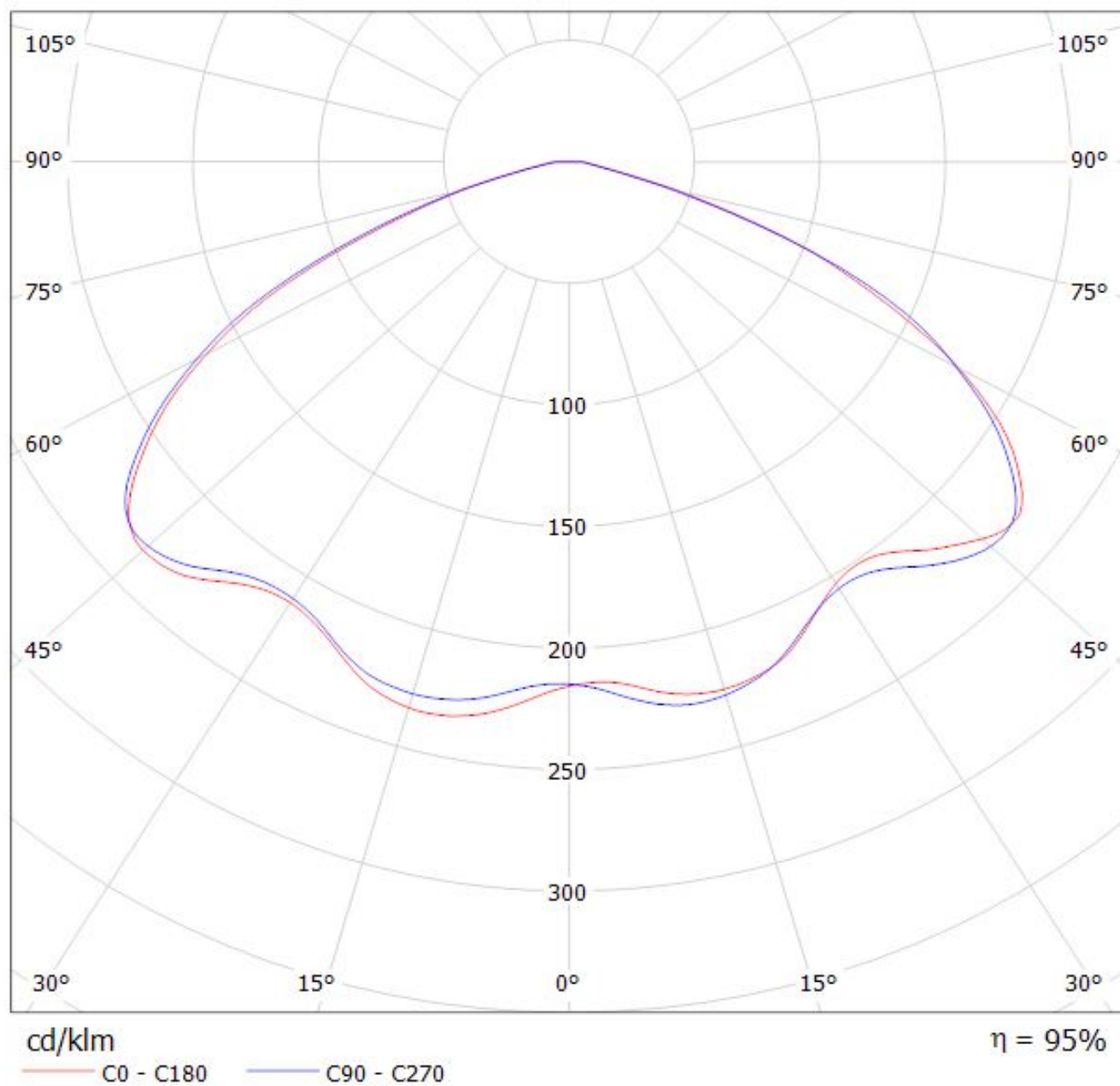

Luminaire: LEDiL Oy C14680\_STRADA-2X2-VSM\_(XT-E)  
Lamps: 1 x Cree\_XT-E\_(2x2)\_382.256lm@250mA\_P=2.98581W\_I=0.2499A

