

微动开关

Micro Switches

型号(TYPE): MSW-14

技术特性 (Specification)

1. 规格 (Rating): 5A 125/250V AC
2. 接触电阻 (Contact R): 30mΩ max
3. 绝缘电阻 (Insulation R): 500V DC 100MΩ min
4. 耐电压 (Dielectric Strength): 1 Minute 1500V AC
5. 环境温度 (Ambient Temperature): -25°C ~ +80°C
6. 电气寿命 (Electrical Life): 100,000 Cycles

外型图 (Outline Drawing)

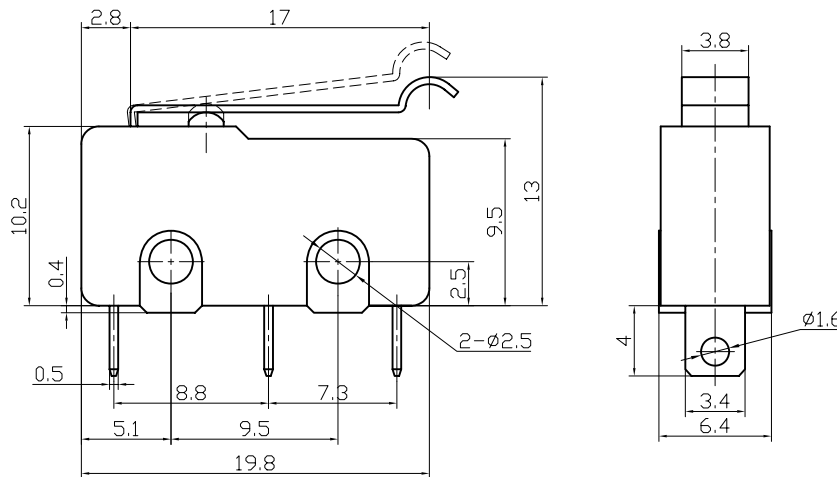

安装尺寸 (Mounting)

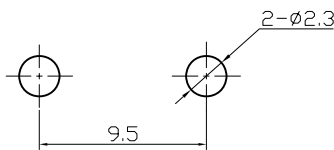

电路图 (Circuitry)

