

Ventostat[®] Wall Mount

Telaire Wall Mount
CO₂, Humidity and
Temperature
Transmitters



Features:

- Patented, Absorption Infrared Gas sensing engine provides high accuracy in a compact low cost package.
- Patented ABC Logic™ self-calibration system eliminates the need for manual calibration in most applications.
- Lifetime CO₂ calibration guarantee when using ABC Logic™.
- Mounting plate with two-piece terminal blocks provide quick, easy wiring.
- Gas permeable, water resistant CO₂ diffusion filter prevents particulate and water contamination of the sensor.
- Locking screw secures cover and sensor to the mounting bracket for tamper resistance.
- Dual simultaneous analog outputs (V & mA) available for CO₂.
- BACnet™ output versions
- Sensors are shipped factory calibrated.
- Temperature sensor on all models.
- Modern enclosure with customized branding available.
- CO₂, humidity and temperature models.
- Two-piece design allows unit to be replaced without the need for rewiring.



Controlled Ventilation

Ventilation is an important part of maintaining a comfortable, healthy, productive environment for people. Improper ventilation can have a negative impact on occupant health and performance, increase the risk from litigation, and/or waste energy. Demand-controlled ventilation using CO₂ sensors prevents energy losses from over-ventilation while maintaining indoor air quality. The most energy savings potential is in buildings where occupancy fluctuates during a 24-hour period. Numerous organizations now require and/or recommend CO₂-based ventilation control in different commercial HVAC applications. Some utility companies also offer rebates to building owners for installing CO₂ sensors.

Wall mount sensors are used to control a specific area such as a conference room, classroom, meeting hall, etc. The Telaire 8000 Ventostat series are easy to install and have a clean, modern look that suits most indoor environments.

Ordering Information

Examples:

- T8100-D ABC Logic, display
- T8100-D-BAC ABC Logic, display, BACnet
- T8200-HD Dual channel, Humidity, Display
- T8300-BAC ABC Logic, pitot tube, BACnet
- T8100-DB ABC Logic, display, black case

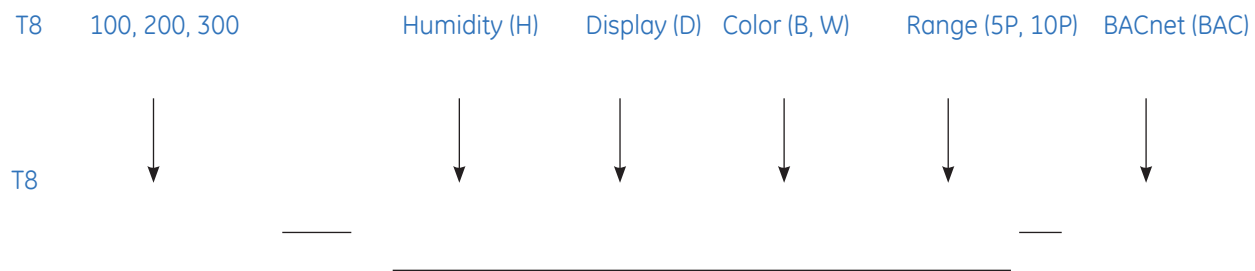

Note: Not all combinations are available, i.e., T8300 with humidity. Please see www.ventostat.com to see the latest list of available part numbers.

The Telaire 8000 Ventostat series is available in a number of configurations. The primary configuration is determined by the type of CO₂ sensor included.

T8100 — uses a single channel sensor using Telaire patented ABC Logic for lifetime calibration. Single-channel sensors are used in spaces where there is not full-time occupation (most applications).

T8200 — uses a dual-channel optical system and three-point calibration process for enhanced stability, accuracy and reliability. Used in applications where there is full-time occupation 24 hours a day.

T8300 — uses a single channel sensor with pitot tube kit for duct measuring of CO₂. ABC Logic enabled.

Notes:

- 1) This product is intended to be used in occupied building HVAC applications.
- 2) This product is not designed or intended for use in safety critical functions.



Black versions are for applications such as movie theaters

Wall Mount Specifications

Sensing Method

- Non-dispersive infrared (NDIR) absorption
- Gold-plated optics
- Patented ABC Logic self calibration algorithm

CO₂ Measurement Range

T8100/T8200/T8300

0 to 2000 ppm (0 ppm = 0 V, 4 mA;

2000 ppm = 10/5V, 20 mA)

T8100/T8200/T8300 - 5P models

0 to 5000 ppm (0 ppm = 0 V, 4 mA;

5000 ppm = 10/5V, 20 mA)

T8200 (10P models) 0 to 10,000 ppm

(0 ppm = 0 V, 4 mA; 10,000 ppm = 10/5V, 20 mA)

T8200 (20P models) 0 to 20,000 ppm

(0 ppm = 0 V, 4 mA; 20,000 ppm = 10/5V, 20 mA)

CO₂ Accuracy

T8100/T8300 - Single Channel

• 400-1250 ppm \pm 30 ppm +3% of reading, whichever is greater*,**

• 1250-2000 ppm \pm 5% of reading + 30ppm *, **

T8200 - Dual Channel

• 75 ppm or 10% of reading (whichever is greater)

*Tolerance based on span gas of \pm 2%

** ABC Logic not deactivated

Power Supply Requirements

18-30 VAC RMS, 50/60 Hz, or 10.8 to 42 VDC, polarity protected

Power Consumption

Typical 0.7 W at nominal voltage of 24V AC RMS

Temperature Dependence

0.2% FS per °C (\pm 0.11% per °F)

Stability

T8100/T8300 - Single Channel

<2% of FS over life of sensor (15 years)

T8200 - Dual Channel

<5% of FS or <10% reading annual over life of sensor (10 years)

Pressure Dependence

0.135% of reading per mm Hg

Warranty

24 months on mechanical defects

Calibration - lifetime warranty for T8100 and T8300 series

Certifications

CE and RoHS compliant

Signal Update

Every 5 seconds

CO₂ Warm-up Time

- < 2 minutes (operational)
- 10 minutes (maximum accuracy)

Operating Conditions

- 32°F to 122°F (0°C to 50°C)
- 0 to 95% RH, non-condensing

Storage Conditions

-40°F to 158°F (-40°C to 70°C)

Flammability Classification

UL94 5VA

Passive Thermistor Type (not Bacnet version)

NTC 10 K Ω thermistor

Thermistor Accuracy

\pm 1°C (15° to 35°C)

RH Sensing Element

Capacitive polymer sensor

RH Range

0% to 99% RH (non-condensing)

RH Accuracy (25°C)

\pm 2.5% RH (20 to 80% RH)

\pm 3.5% RH (<20% and >80% RH)

Active Temperature Accuracy

\pm 0.8°C @ 22°C

Active Temperature Range

32°F to 122°F (0 to 50°C)

Output

Analog Version

- 0 to 10 V (100 Ω output impedance) and
- 4 to 20mA (R_L maximum 500 Ω) available simultaneously
- Digital to Analog Error \pm 1% (BACnet versions not applicable)

BACnet Version

- MS/TP
- RS485
- Baud rates 38400 or 9600

Relay (BACnet version only)

- 5PDT, gold bilocated
- 2.4 max at 224 V
- Threshold 1000 ppm

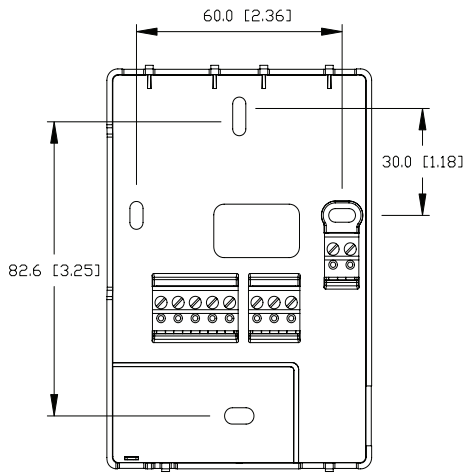
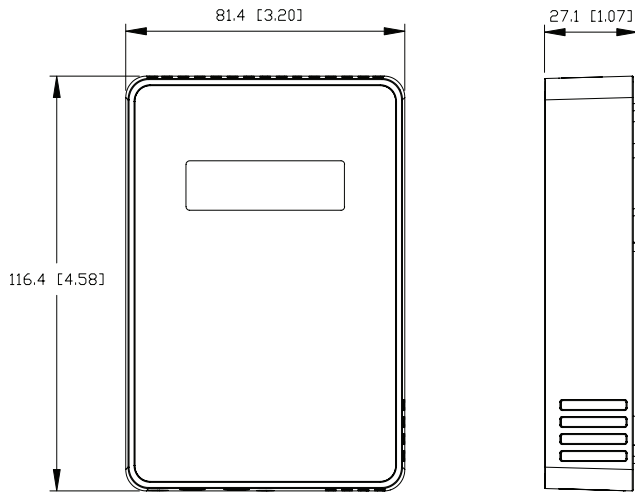

Ventostat wall mount dimensions

Sensor Accuracy & Field Calibration

CO₂ ABC Logic Self Calibration

T8100 and T8300 single channel sensors employ the patented ABC (Automatic Background Calibration) Logic self-calibration system. ABC Logic virtually eliminates the need for manual calibration in applications where the indoor CO₂ level drops to outside levels during unoccupied periods (e.g. during evening hours). ABC Logic is a special software routine in the sensor that remembers the background readings for 14 consecutive evenings, calculates if there is a sensor drift, and then corrects for it.

With ABC Logic enabled, the sensor will typically reach its operational accuracy after 25 hours of continuous operation at a condition that is exposed to ambient reference levels. Sensors will maintain accuracy specifications with ABC Logic enabled, given that it is at least three times in 14 days exposed to the reference value and this reference value is the lowest concentration to which the sensor is exposed.

Note: Applies when used in typical indoor ambient air. Consult GE if other gases or corrosive agents are part of the application environment.

CO₂ Calibration Guarantee

GE is serious about minimizing maintenance, so each single-channel sensor (T8100/T8300) comes with a lifetime calibration guarantee. And each dual channel sensor has a two-year calibration guarantee (T8200).

Calibration Interval

For T8100 and T8300 series, no calibration is required due to ABC Logic. For T8200 series, annual calibration is recommended for the best accuracy. However, most applications using T8200 series could extend the calibration interval. For the humidity sensor, no calibration is required. Replacement humidity sensors are available. If a Telaire 8000 series single channel sensor drifts out of calibration range, it can be sent back to Telaire for a free factory calibration. Further information on the guarantee is available on our website.

T8200 – Dual Channel

The T8200 dual channel sensor can be described as a CO₂ channel that measures gas concentration and a reference channel that measures the sensor signal intensity. The dual channel sensor performs periodic self-calibrations using the reference channel. The self-calibrations are approximately every 24 hours. During the self-calibration the sensor ppm reading is frozen, it will not react to changing CO₂. The calibration time is adjustable but nominally two minutes.

GE recommends periodic gas calibration depending on the application accuracy requirements. While the reference channel corrects for changes over time, a field calibration using nitrogen gas or alternatively ambient calibration will immediately restore the highest level of accuracy. Refer to the calibration manual for details.

Multi Measurement



Display versions scroll between ppm CO₂, %RH Humidity and °F Temperature when the option is selected.

Wiring Features

Non-Display Wiring

No display, basic functionality for CO₂ and passive thermistor only.

Display Wiring

Digital display, functions of CO₂ and thermistor are standard. Humidity and active temperature options are available. Display scrolls all measurements that are included.

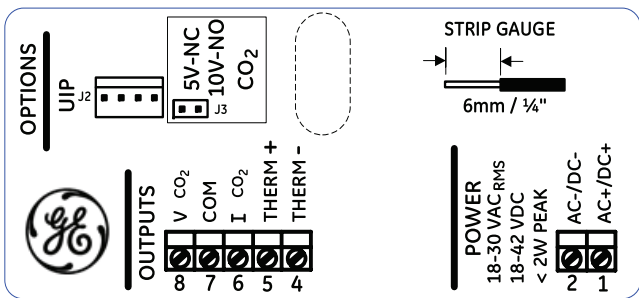

Non-Display Wiring

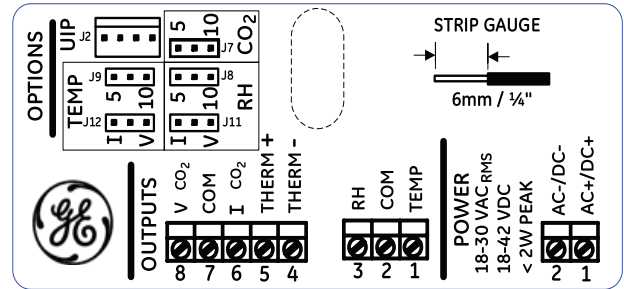

Display Wiring

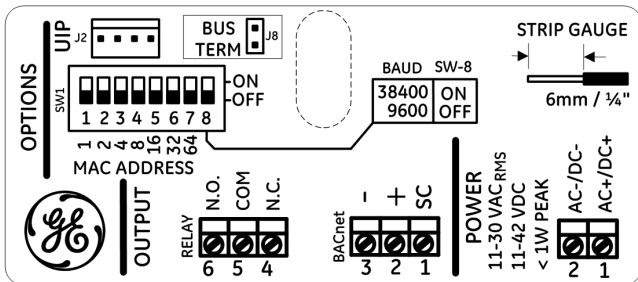

BACnet Wiring



Larger Enclosures

Larger enclosure versions are available for regional preferences.



Dimensions: 81.4 mm x 116.4 mm.

8300 Pitot Tube Configuration

The pitot tube kit is used for duct measurement of CO₂. The pitot tube is installed in the duct and the sensor is mounted remotely, which allows for easy access.

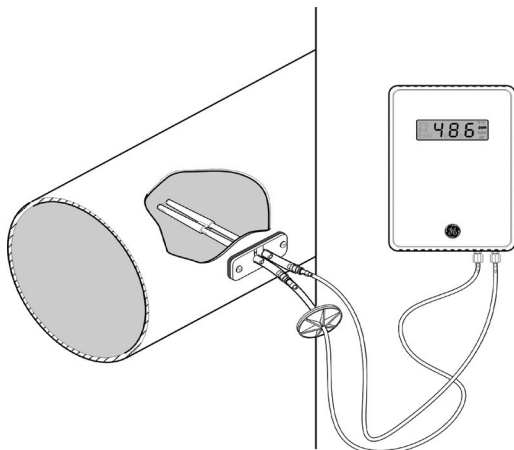

Pitot Mounting Configuration

Enhanced Field Serviceability

The Ventostat 8000 series features a field-replaceable Relative Humidity (RH) sensor tip module that allows the end user to replace the sensor on-site while maintaining $\pm 2.5\%$ RH accuracy. The user simply powers off the unit, installs the new sensor module and powers back the unit. This virtually eliminates the need for time consuming and costly factory calibration, while reducing downtime during service intervals to near zero. The sensor is protected from dust contamination by a specially designed filter as shown in the photo below.



T8300-D with Pitot



T8300 with Pitot

Ventostat Accessories

Enclosure Specifications

T1508 Aspiration Box for Duct Mounting

The Model 1508 is designed for in-duct sampling of CO₂ concentrations at flow rates greater than 400 fpm. Clear cover allows for observation of the sensor. They will accommodate any of the Ventostat 8100 or 8200 series, and can be used for temperature and RH when fitted. Enclosure is screwed to the duct with probe inserted into air stream. Air sampling probe is 1-inch (25.4mm) diameter and 8-inch (203.2mm) long. Enclosure (ABS plastic) has knockouts for conduit connection. Note: Wiring penetrations must be sealed prior to use. CO₂ sensor not included.



T1508 Aspiration Box for Duct Mounting

T1505 Splash Resistant Enclosure

The Model 1505 is designed to protect the 8000 series in damp or wet environments as might occur in agricultural, industrial or food processing environments. This enclosure (ABS plastic) is designed to protect the sensor from dripping or sprayed water. Any wall mount model of the Ventostat 8000 series sensor can be installed inside the enclosure. The transparent cover allows for viewing of the sensor/display. Four diffusion ports allow for entry of CO₂. Knockouts are provided for conduit connection. Response time of the sensor is slowed to approximately 30 minutes to measure a 90% step change in concentrations. Enclosure is designed to screw directly to a wall. CO₂ sensor not included.

T1552 Outside Air Enclosure

The Model 1552 is a rugged weatherproof enclosure (ABS plastic), designed to allow the 8000 series sensor to operate in an outdoor environment and/or where ambient temperatures are below freezing. The 1552 is ideal for monitoring outside air or CO₂ as a surrogate for combustion fumes in parking garages, tunnels and loading docks. This enclosure features a temperature control circuit and internal heaters to maintain the sensor within its normal operating temperature range, even if temperatures outside the enclosure are as low as -20°F (-29°C). Four diffusion ports allow for entry of CO₂. Response time of the sensor is slowed to approximately 30 minutes to measure a 90% step change in concentrations. Enclosure is designed to screw directly to a wall. CO₂ sensor not included. Power consumption is 24V, 1.5 Amp (max), and includes the Ventostat 8000 series.



T1505 Splash Resistant Enclosure and
T1552 Outside Air Enclosure

Ventostat UIP Software

The Ventostat UIP software allows you to modify the standard settings on the T8100, T8200 and T8300 series products.

The software features:

- Altitude adjustment for maximum accuracy performance
- Analog output adjustment
- Single point and span gas calibration
- Turn on and off ABC Logic™
- Change temperature display units
- Graphing and logging of CO₂, temperature and %RH (H Versions only)

The software can be used by distributors to make modifications to the Ventostat prior to shipping to the customer, as well as to make adjustments in the field. The USB cable supplies power to the Ventostat, negating the need for a separate power supply.

The T2090 UIP software kit is supplied with a USB-to-Ventostat cable and software CD.

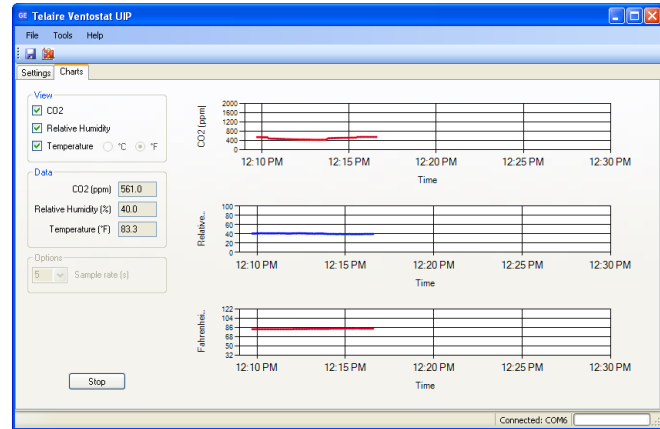
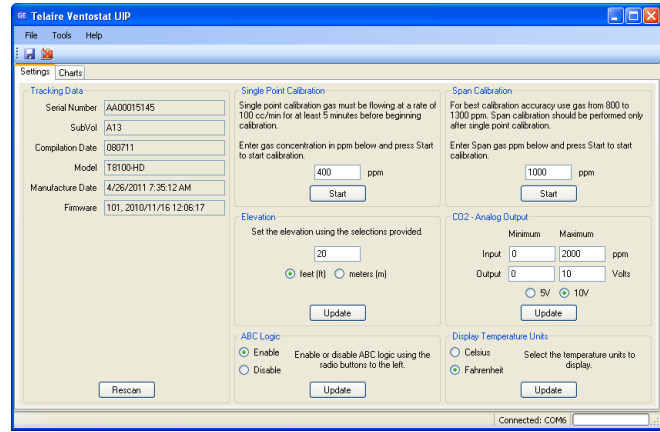

www.ge-mcs.com

920-585A