

QUARTZ CRYSTAL UNIT

SERIES 7U, SEAM SEALED CERAMIC 3.2*2.5MM SURFACE MOUNT PACKAGE



Approved by:
Checked by:
Issued by:

SPECIFICATION

MODEL: SJK-7U-26.00-9-10-60-B-10

深圳市晶科鑫实业有限公司

SHENZHEN CRYSTAL TECHNOLOGY INDUSTRIAL CO., LTD.

Add: RM#1805, East Wing, TianAn Hi-tech Plaza Phase2, TianAn Cyber Park Shenzhen, China

Tel: (86) 755 88352809 88352810 Fax: (86) 755 88353718 88352499

E-mail: jolly@q-crystal.com HTTP://www.q-crystal.com

QUARTZ CRYSTAL UNIT



SERIES 7U, SEAM SEALED CERAMIC 3.2*2.5MM SURFACE MOUNT PACKAGE

FEATURE

- I Ultra thin, thickness 1.0mm
- I Leadless type
- I High precision characteristic covering up to high frequency range
- I Designed for automatic mounting and reflow soldering
- I Embossed taping specification
- I The best choice of Bluetooth wireless communication sets, DSN, PDA and mobile phone

ELECTRICAL SPECIFICATIONS

Output Frequency Range	26.00 MHz
Mode	AT/Fundamental
Frequency Tolerance (at 25°C)	±10ppm
Frequency Stability Over Operating Temperature Characteristics	±10ppm
Operating Temperature Range	-20 °C to +70 °C
Storage Temperature Range	-40 °C to +85 °C
Shunt Capacitance (C ₀)	5.0 PF Max
Driver Level (Typical)	100μW
Load Capacitance(C _L)	9 PF
Equivalent Series Resistance(ESR)	60 Ω Max
Aging @25°C 1 st year (Max)	±3ppm/year

REMARK: SPECIFICATIONS SUBJECT TO CHANGE WITHOUT PRIOR NOTICE.
PLEASE CONFIRM WITH OUR SALES ENGINEER.

Add: RM#1805, East Wing, TianAn Hi-tech Plaza Phase2, TianAn Cyber Park Shenzhen, China
Tel: (86) 755 88352809 88352810 Fax: (86) 755 88353718 88352499
E-mail: jolly@q-crystal.com HTTP://www.q-crystal.com

QUARTZ CRYSTAL UNIT

SERIES 7U, SEAM SEALED CERAMIC 3.2*2.5MM SURFACE MOUNT PACKAGE



Dimension

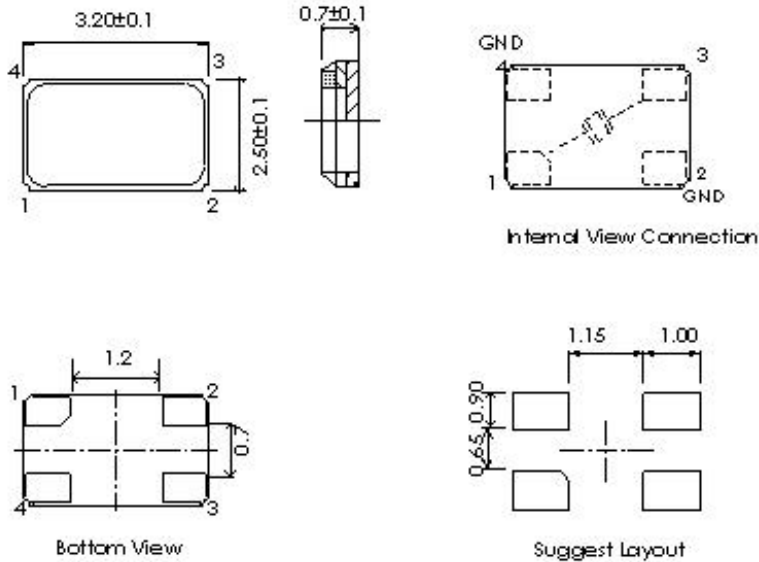

Reflow Condition

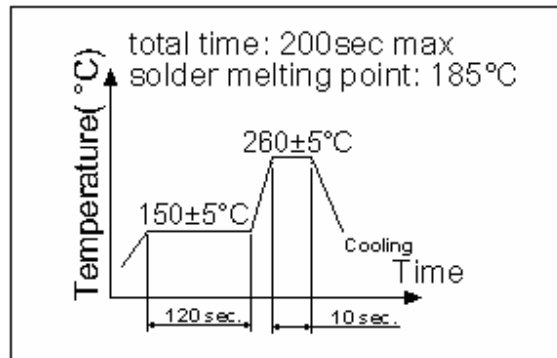

PART NUMBER

SJK-7U-	26.000M	9	10	60	B	10
	Frequency e.g. 26.000: 26.000MHz	Load capacitance e.g. 9:9pF s: series	Frequency tolerance e.g. 10: ±10ppm	E.S.R.Max e.g. 60:60Ωmax	Operating temperature range A:-10-60°C B:-20-70°C C:-40-85°C	Temperature stability: e.g. 10: ±10ppm

Add: RM#1805, East Wing, TianAn Hi-tech Plaza Phase2, TianAn Cyber Park Shenzhen, China
 Tel: (86) 755 88352809 88352810 Fax: (86) 755 88353718 88352499
 E-mail: jolly@q-crystal.com HTTP://www.q-crystal.com

QUARTZ CRYSTAL UNIT

SERIES 7U, SEAM SEALED CERAMIC 3.2*2.5MM SURFACE MOUNT PACKAGE



PACKING

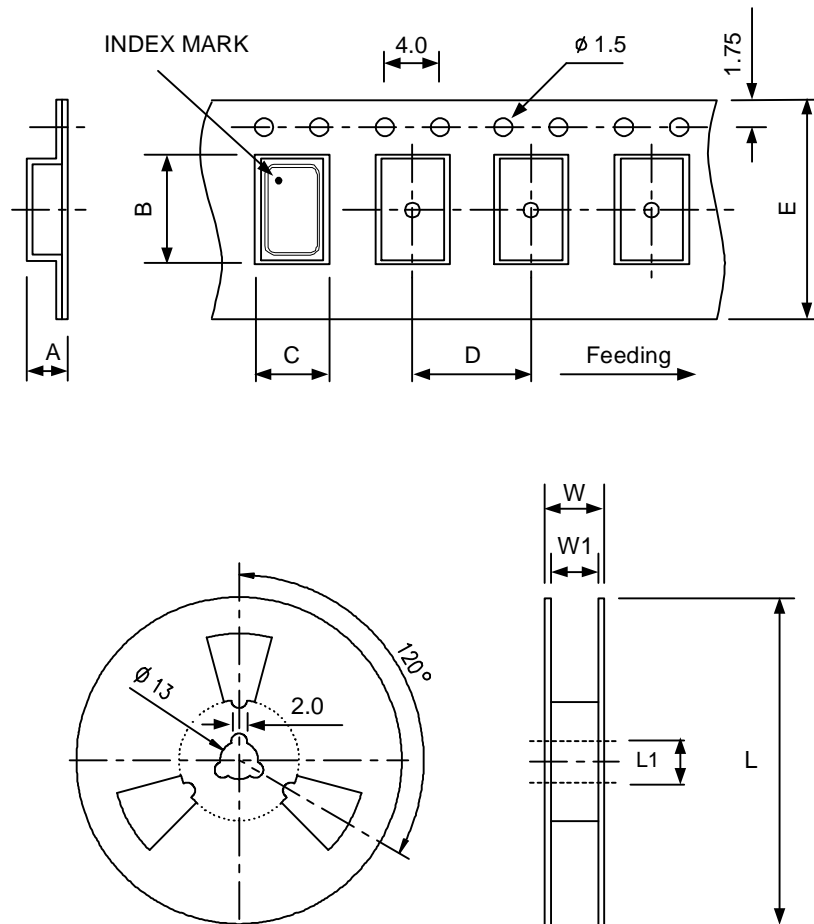

DIMENSIONS		A	B	C	D	E	L	L1	W	W1	pcs / Reel
	7050		2.15	7.9	5.4	8.0	16	180	13	21.5	17.5
6035		1.4	6.4	3.9	8.0	12	180	13	15.4	13	
5032		1.46	5.5	3.6	8.0	12	180	13	15.4	13	
4025		1.5	4.4	8.0	2.8	13	176	13	13.5	12	
3225		1.4	3.4	2.7	4	8	178	13	11.5	8	

Add: RM#1805, East Wing, TianAn Hi-tech Plaza Phase2, TianAn Cyber Park Shenzhen, China
 Tel: (86) 755 88352809 88352810 Fax: (86) 755 88353718 88352499
 E-mail: jolly@q-crystal.com HTTP://www.q-crystal.com

QUARTZ CRYSTAL UNIT

SERIES 7U, SEAM SEALED CERAMIC 3.2*2.5MM SURFACE MOUNT PACKAGE



RELIABILITY TEST SPECIFICATION

Test item	Equipment	Condition	Specification
1. SOLDERABILITY TEST	TBAEI ESPEC(K-1425-14D)	Welding can be temperature: 260 ± 5 °C, 5' s(125 °C, 120 SEC preheating Anti-welding temperature: 260 ± 5 °C, soaking time: 10 seconds	MIL-STD-883E Method 2003.7
2. HERMETICITY TEST	Helium leak detectors	1. Small leak: 4.5 KGF/CM2 2hours1 * 10-9-9 PA.M3/SEC crude leak: 4.5KGF/CM2 2hours1.5 * 10-5 PA.M3/SEC	MIL-STD-883E Method 1014.10
3. VIBRATION TEST	Sweep vibration test machines (IMV CO. (VS-300-2)), S & A250B	1 Crystal on 10-2000 Hz, X, Y, Z water level, each 20-minute vibration, a test every four hours, then the sample used to test 250 b	MIL-STD-883E Method 2007.3
4. MECHANICAL SHOCK	TOOL	A high degree of crystal from 150 CM to 150 g of three directions from the direction of impact X.Y.Z3 work hard wooden board	JIS C6701
5. MECHANICAL IMPACT TEST	TOOL	c1000G, 0.5Msec, 3, from the X, Y, Z three-day direction of hard wood boards, then the sample used to test 250 B	MIL-STD-202F Method 213B
6. DROP TEST	Fell hard wood equipment, S & A 250B	Crystal 75 cm in height, falling three times in the hard wooden board	JIS C6701
7. SALT SPRAY	H-SST-60、RC-328A	5% NaCl (sodium carbonate), 35 ± 2 °C temperature of the box, 48 hours, PH value: 6.5 to 7.2	
8. HIGH&LOW TEMP STORAGE TEST	TABEL ESPEC(MC-810), S&A 350B/250B	High temperature: 125 ± 2 °C, 500 hours; low temperature: -40 ± 3 °C, 500hours	MIL-STD-883E Method 1005.8
9. TEMP& HUM CYCLING TEST	TABEL ESPEC (TPC-211) S&A350B/250B	Temperature: $121 + / -3$ °C RH100% 2BAI, 240hours	JIS C6701
10. HIGH TEM. & HUM. STORAGE TEST	TBAEL ESPEC (PH-3F) , S&A350B/250B	Temperature: 40 ± 2 , Humidity: 85 +3, -2%, storage 96 hours	JIS C5023
11. AGING TEST	PRA(2360)	Temperature: 85 ± 3 °C, 1000hours	JIS C6701

Add: RM#1805, East Wing, TianAn Hi-tech Plaza Phase2, TianAn Cyber Park Shenzhen, China

Tel: (86) 755 88352809 88352810 Fax: (86) 755 88353718 88352499

E-mail: jolly@q-crystal.com HTTP://www.q-crystal.com