

# **Vacuum Fluorescent Display Module Specification**

Model: GU140X16J-7000B

Specification No.:	DS-1711-0000-01	
Date of Issue:	November 29, 2011	(00)
Revision:	April 27, 2012	(01)

Published by  
NORITAKE ITRON CORP. / Japan  
<http://www.noritake-itron.jp>

This specification is subject to change without prior notice.

**This product complies with RoHS Directive 2011/65/EU**

## Contents

<b>1</b>	<b>General Description</b>	<b>3</b>
1.1	Scope	3
1.2	Construction	3
1.3	Outline	3
1.4	Weight	3
1.5	Block Diagram	3
<b>2</b>	<b>Electrical specifications</b>	<b>4</b>
2.1	Absolute Maximum Ratings	4
2.2	Electrical ratings	4
2.3	Electrical Characteristics	4
<b>3</b>	<b>Optical Specifications</b>	<b>5</b>
<b>4</b>	<b>Environmental Specifications</b>	<b>5</b>
<b>5</b>	<b>Interface</b>	<b>5</b>
5.1	Type of interface	5
5.2	Parallel interface	5
5.2.1	Basic function	5
5.2.2	Parallel Interface timing	6
5.3	Serial interface	7
5.3.1	Basic function	7
5.3.2	Asynchronous serial interface timing	7
5.4	Reset timing	7
<b>6</b>	<b>Display specification</b>	<b>8</b>
6.1	Displayable image types	8
6.1.1	Graphic display	8
6.1.2	Character display	8
6.2	Display memory	8
6.3	Window	9
6.3.1	Base-Window	9
6.3.2	User-Window	9
6.4	Write screen mode	10
6.4.1	Display screen mode	10
6.4.2	All screen mode	10
6.5	Character display format	11
<b>7</b>	<b>Function</b>	<b>12</b>
7.1	Commands	12
7.1.1	Character display	12
7.1.2	BS (Back Space)	13
7.1.3	HT (Horizontal Tab) – 1 character to right	13
7.1.4	LF (Line Feed)	14
7.1.5	HOM (Home Position)	15
7.1.6	CR (Carriage Return)	15
7.1.7	US \$ xL xH yL yH (Cursor Set)	15
7.1.8	CLR (Display Clear)	15
7.1.9	US C n (Cursor display)	15
7.1.10	ESC @ (Initialize Display)	15
7.1.11	ESC % n (Download character ON/OFF)	16
7.1.12	ESC & a c1 c2 [x1 d1...d(afx1)]...[xk d1...d(afxk)] (Download character definition)	16
7.1.13	ESC ? a c (Download character delete)	17
7.1.14	ESC R n (International font set)	17
7.1.15	ESC t n (Character table type)	17
7.1.16	US MD1 (Over-write mode)	17
7.1.17	US MD2 (Vertical scroll mode)	18
7.1.18	US MD3 (Horizontal scroll mode)	18
7.1.19	US s n (Horizontal scroll speed)	18
7.1.20	US r n (Reverse display)	18
7.1.21	US w n (Write mixture display mode)	19
7.1.22	US X n (Brightness level setting)	19
7.1.23	US ( a n [parameter] (Display action command group)	19
7.1.24	<Function 01h> US ( a 01h t (Wait)	19
7.1.25	<Function 10h> US ( a 10h wL wH cL cH s (Scroll display action)	20
7.1.26	<Function 11h> US ( a 11h p t1 t2 c (Blink)	21
7.1.27	<Function 40h> US ( a 40h p (Screen saver)	21

7.1.28	US ( f n [parameter] ( <i>Bit image display group</i> ) .....	22
7.1.29	<Function 11h> US ( f 11n xL xH yL yH g d(1)...d(k) ( <i>Real-time bit image display</i> ) .....	22
7.1.30	US ( d n [parameter] ( <i>Dot unit command group</i> ) .....	23
7.1.31	<Function 20h> US ( d 20h xPL xPH yPL yPH m aL aH aE ySL ySH xOL xOH yOL yOH xL xH yL yH g ( <i>Dot unit downloaded bit image display</i> ) .....	23
7.1.32	<Function 21h> US ( d 21h xPL xPH yPL yPH xL xH yL yH g d(1)...d(k) ( <i>Dot unit real-time bit image display</i> ).....	24
7.1.33	<Function 30h> US ( d 30h xPL xPH yPL yPH m bLen d(1)...d(bLen) ( <i>Dot unit character display</i> ) .....	26
7.1.34	US ( g n [parameter] ( <i>Font command group</i> ).....	27
7.1.35	<Function 03h> US ( g 03h w ( <i>Font Width</i> ) .....	27
7.1.36	<Function 40h> US ( g 40h x y ( <i>Font Magnification</i> ).....	27
7.1.37	US ( w n [parameter] ( <i>Window command group</i> ) .....	28
7.1.38	<Function 01h> US ( w 01h a ( <i>Window select</i> ) .....	28
7.1.39	<Function 02h> US ( w 02h a b[xPL xPH yPL yPH xSL xSH ySL ySH] ( <i>User Window define / cancel</i> ) .....	29
7.1.40	<Function 10h> US ( w 10h a ( <i>Write screen mode select</i> ).....	30
7.1.41	WINx ( <i>Window select shortcut</i> ).....	30
7.2	<i>Bit image data format</i> .....	31
<b>8</b>	<b>Setup</b> .....	<b>32</b>
8.1	<i>Jumper</i> .....	32
8.1.1	Baud rate setting (for serial interface).....	32
8.1.2	Parallel interface through-holes Pin #3 signal setting.....	32
<b>9</b>	<b>Connector</b> .....	<b>33</b>
9.1	<i>Parallel interface 14 through-holes (CN3)</i> .....	33
9.2	<i>Serial interface 7 through-holes (CN2)</i> .....	33
<b>10</b>	<b>Firmware Version Notation</b> .....	<b>33</b>
<b>11</b>	<b>Outline Drawing</b> .....	<b>34</b>
	<b>Notice for the Cautious Handling of VFD Modules</b> .....	<b>35</b>
	<b>Revision Note</b> .....	<b>36</b>

## 1 General Description

### 1.1 Scope

This specification covers the operation and operating requirements of the vacuum fluorescent graphic display module GU140X16J-7000B.

### 1.2 Construction

The module consists of a 140 × 16 dot graphic BD-VFD, refresh RAM, character generator, DC/DC converter, display controller, and all necessary control logic.

The module can simultaneously display graphic patterns and characters on the screen.

### 1.3 Outline

Power supply: Single 5 V<sub>DC</sub> power supply  
 Interface: Parallel interface (CMOS-level)  
 Serial interface (Asynchronous, can accept RS-232 level)  
 Function: Character display – 5×7 dot, with display attributes  
 5×7 Character font (specification DS-898-0002-xx)  
 Graphic display  
 Control command  
 Character download function  
 Screen saver function

Applicable VFD Module reliability specification : TT-99-3102

Applicable VFD Module quality specification : TT-98-3413

Applicable VFD quality specification : TT-93-3336D

### 1.4 Weight

Approximately 74g

### 1.5 Block Diagram

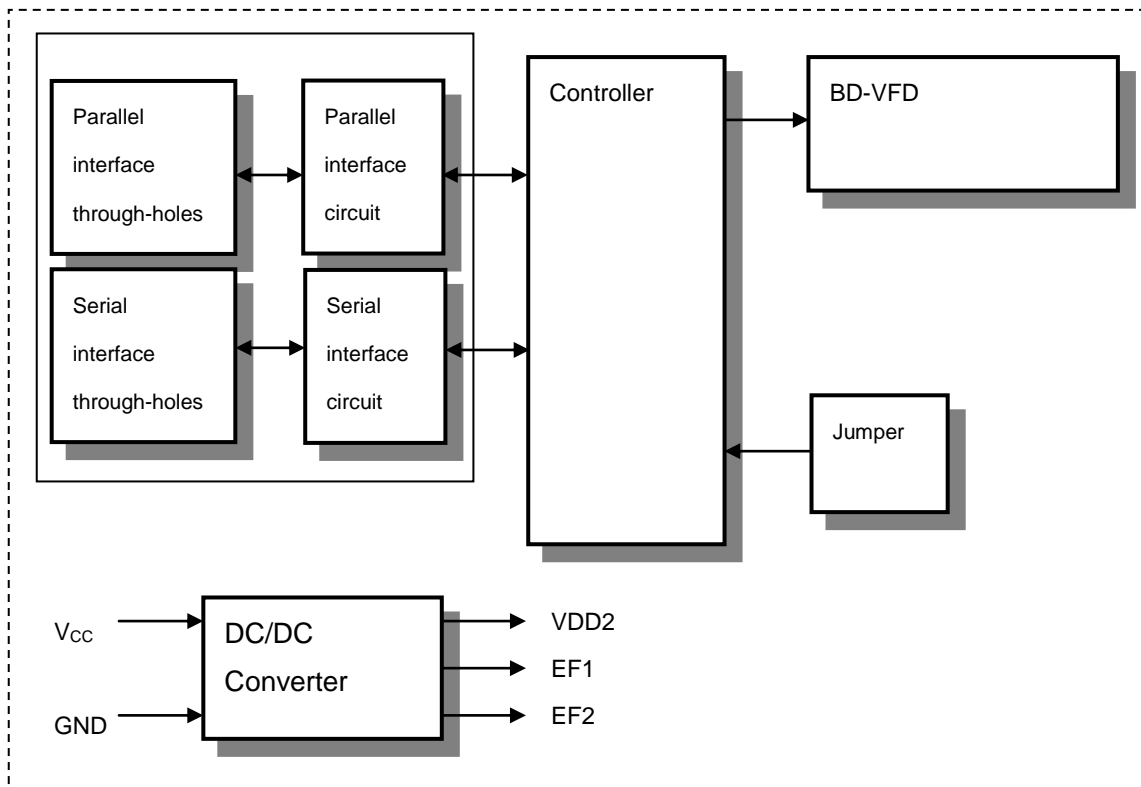

## 2 Electrical specifications

### 2.1 Absolute Maximum Ratings

Parameter	Symbol	Min.	Typ.	Max.	Unit
Power Supply Voltage	$V_{CC}$	-0.3	-	+6.0	$V_{DC}$
Logic Input Voltage D0-D7, /WR, /RD, /RESET	$V_{IN1}$	-0.3	-	$V_{CC}+0.3$	$V_{DC}$
Logic Input Voltage SIN	$V_{IN2}$	-20.0	-	+20.0	$V_{DC}$

### 2.2 Electrical ratings

Parameter	Symbol	Min.	Typ.	Max.	Unit
Power Supply Voltage	$V_{CC}$	4.75	5.0	5.25	$V_{DC}$

Driving voltage for the VFD is obtained from the on-board DC/DC converter.

### 2.3 Electrical Characteristics

Measuring Conditions: Ambient temperature = 25 °C,  $V_{CC} = 5.0 V_{DC}$

Parameter	Symbol	Min.	Typ.	Max.	Unit	Condition	Note	
'L' Level Logic Input Current D0-D7, /WR, /RD	$I_{IL1}$	-	-	-0.15	mA	$V_{IN1}=0V$		
'L' Level Logic Input Current /RESET	$I_{IL2}$	-	-	-0.6	mA	$V_{IN1}=0V$		
'H' Level Logic Input Current D0-D7, /WR, /RD, /RESET	$I_{IH}$	-	-	1.0	$\mu A_{DC}$	$V_{IN1}=5V$	-	
Logic Input Voltage D0-D7,/WR,/RD, /RESET	'H'	$V_{IH1}$	$0.8V_{CC}$	-	$V_{CC}$	-	-	
	'L'	$V_{IL1}$	0	-	$0.2V_{CC}$	$V_{DC}$	-	
Logic Output Voltage D7(Busy flag), PBUSY	'H'	$V_{OH1}$	3.8	-	$V_{CC}$	$V_{DC}$	$I_{OH1}=-1.5mA$	-
	'L'	$V_{OL1}$	0	-	0.6	$V_{DC}$	$I_{OL1}=1.6mA$	-
Logic Input Resistance SIN	$R_{IN}$	3	-	-	k $\Omega$	-	-	
Logic Input Voltage SIN	'H'	$V_{IH2}$	3.0	-	+15	$V_{DC}$	-	-
	'L'	$V_{IL2}$	-15	-	0.5	$V_{DC}$	-	-
Logic Output Voltage SBUSY	'H'	$V_{OH2}$	4.0	-	$V_{CC}$	$V_{DC}$	$R_L=3k\Omega$	-
	'L'	$V_{OL2}$	0	-	0.5	$V_{DC}$	$R_L=3k\Omega$	-
Power Supply Current 1	$I_{CC1}$	-	500	650	$mA_{DC}$	-	(1)	
Power Supply Current 2	$I_{CC2}$	-	390	510	$mA_{DC}$	-	(2)	
Power Supply Current 3	$I_{CC3}$	-	25	35	$mA_{DC}$	-	(3)	
Power Consumption		-	2.5	3.25	W	-	(1)	

Note:

- (1)  $I_{CC1}$  is the current when all dots in the display are on.
- (2)  $I_{CC2}$  is the current when all dots in the display are off.
- (3)  $I_{CC3}$  is the current in Display Power OFF Mode (power-save mode).

At power-on, inrush current can be approximately twice the current in the above table rush.  
A quick-rise type power supply (<100ms) is recommended.

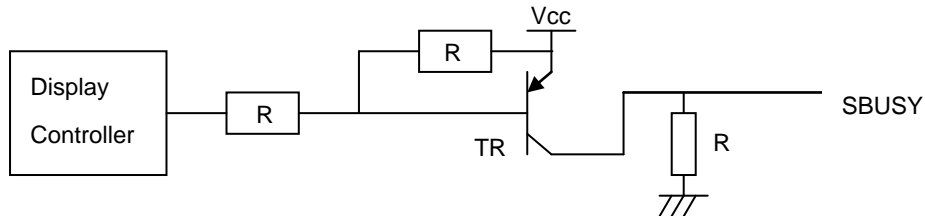

### 3 Optical Specifications

Number of dots:	2,240 (140 × 16)
Display area:	102.75mm × 18.8mm (X × Y)
Dot size:	0.585mm × 1.025mm (X × Y)
Dot pitch:	0.735mm × 1.185mm (X × Y)
Luminance:	350cd/m <sup>2</sup> Min. (1000cd/m <sup>2</sup> Typ.)
Color of illumination:	Green (Blue Green)

### 4 Environmental Specifications

Operating temperature:	-40 to +85 °C
Storage temperature:	-40 to +85 °C (-60 to -40 °C in less than 168 hours.)
Operating humidity:	20 to 80 % RH (non-condensing)
Storage humidity:	20 to 80 % RH (non-condensing)
Vibration:	10-55-10Hz, all amplitude 1mm, X-Y-Z, 30 minutes (non-operating)
Shock:	392m/s <sup>2</sup> (40G), 9ms, X-Y-Z, 3 times each direction (non-operating)

### 5 Interface

#### 5.1 Type of interface

The following interfaces are available on this module:

Parallel interface (CMOS-level)

Serial interface (Asynchronous, can accept RS-232 level)

#### 5.2 Parallel interface

##### 5.2.1 Basic function

The module sets the PBUSY line upon receipt of data, and clears the line when ready to receive more data. PBUSY signal can be read directly, or by bit D7 Status read.

RS terminal is not used in this module.

Operation	/WR	/RD	/RS	D0-D7
Data write	0 → 1	1	X	D0-D7: Data write
Status read	1	0	X	D0-D6: Undefined D7: PBUSY Flag 1:BUSY, 0:READY

### 5.2.2 Parallel Interface timing

Write timing

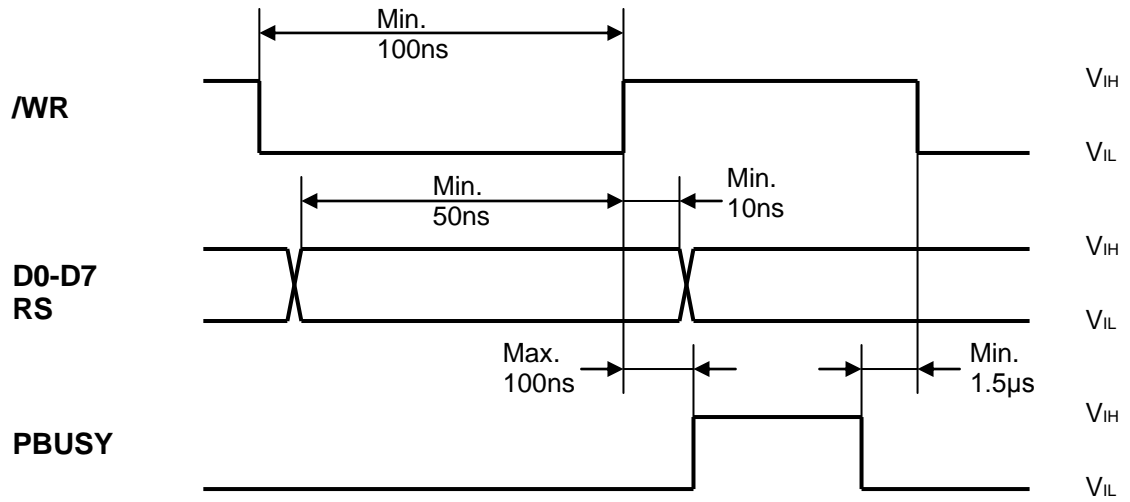

Read timing

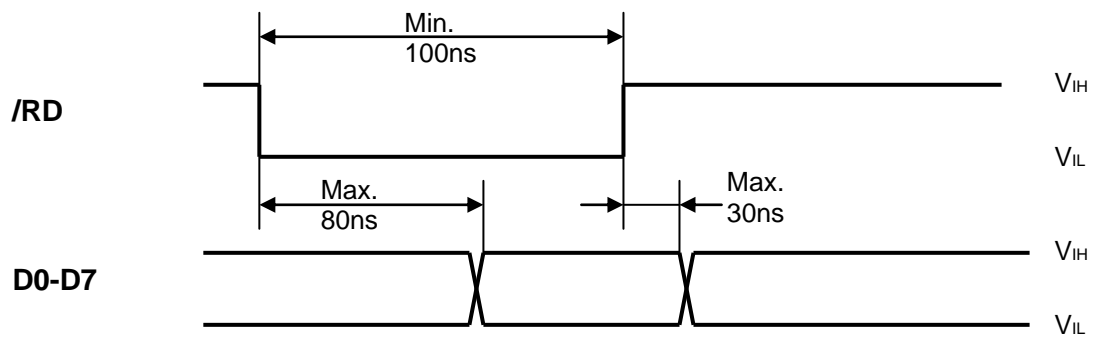

### 5.3 Serial interface

#### 5.3.1 Basic function

The asynchronous serial interface can accept RS-232 level input. The module sets the SBUSY line upon receipt of data, and clears the line when ready to receive more data.

#### 5.3.2 Asynchronous serial interface timing

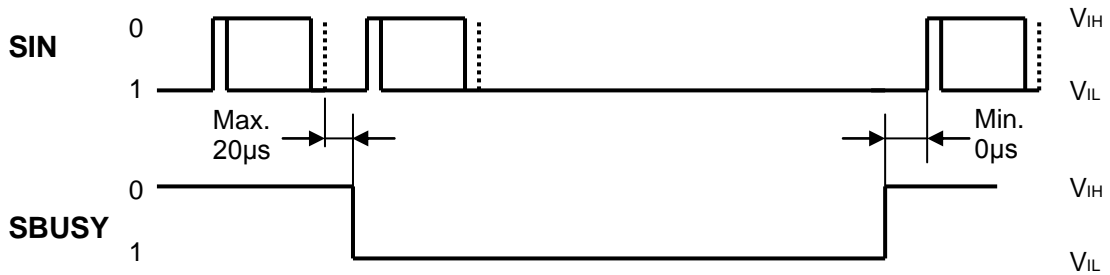

Interface:

<b>Baud rate</b>	9,600 / 19,200 / 38,400 / 115,200bps (set by Jumper)
<b>Parity</b>	None
<b>Format</b>	Start (1 bit) + Data (8 bit) + Stop (1 bit)
<b>Handshake</b>	SBUSY

Receive buffer capacity: 60 bytes

SBUSY change timing:

SBUSY	1 (BUSY)	0 (READY)
Condition	Data in receive buffer	No data in receive buffer

To prevent data loss, data should not be sent when SBUSY=1.

### 5.4 Reset timing

Reset pulse (active low) should be longer than 1ms.

The module sets the SBUSY/PBUSY line upon receipt of Reset signal and clears the line when ready to receive data.

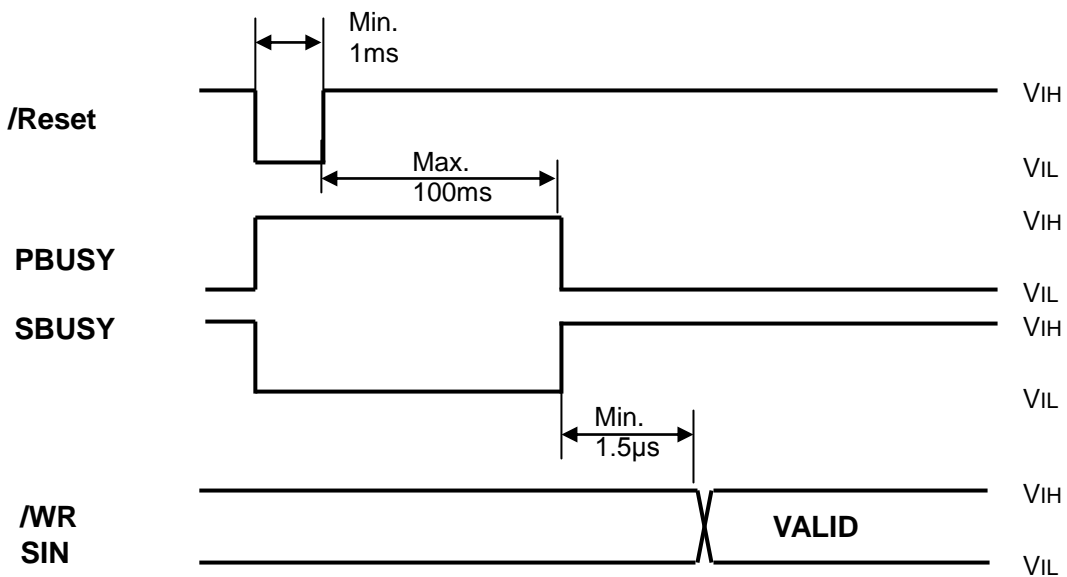



## 6 Display specification

### 6.1 Displayable image types

#### 6.1.1 Graphic display

Number of dots: 140x16 dots

#### 6.1.2 Character display

Character mode: 5x7 dot

Character font type: 5x7 dot characters: ANK, international font

Character display width: Fixed character format 1 & 2, Proportional character format 1 & 2

Attribution: Font Magnification, Reverse

### 6.2 Display memory

Size: 512 x 16 dots - separated as: Display area (140 x 16dots)

Hidden area (372 x 16dots)

Display Memory is comprised of Display area and Hidden area, as shown below.

By using "User Window" function, the memory area can be separated, and each separate window can be controlled independently (refer to 7.1.37 Window command group, page 28).

Hidden area can be displayed by using scroll or other action commands (refer to 7.1.23 Display action command group, page 19).

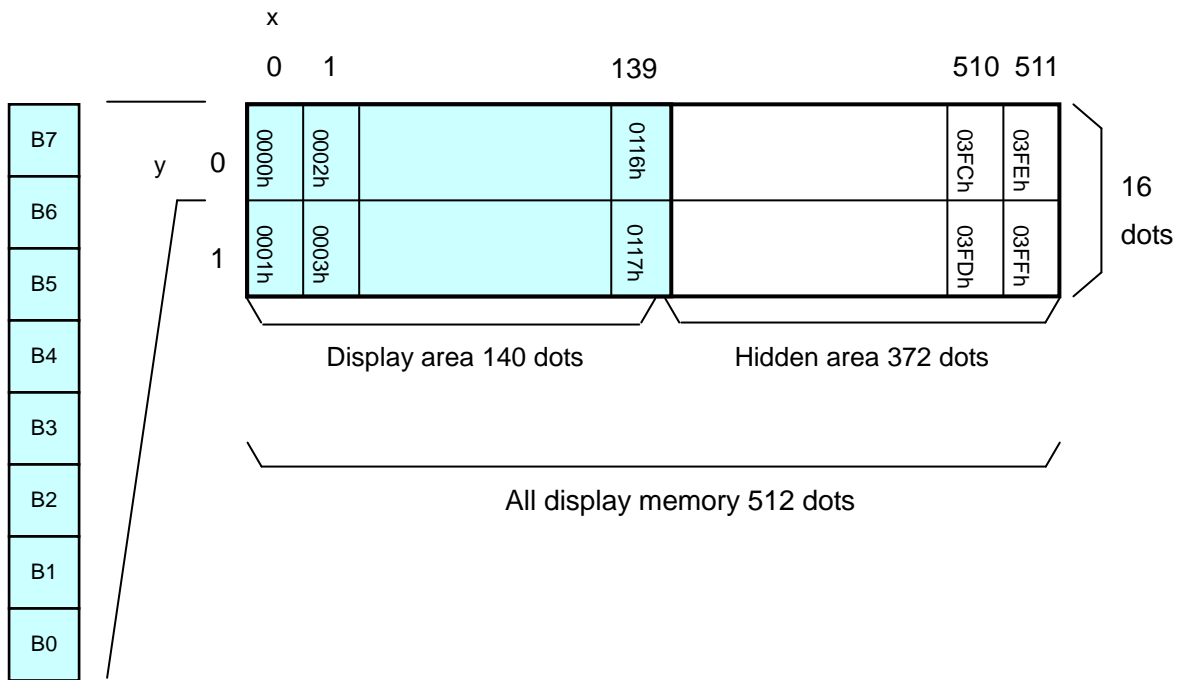

### 6.3 Window

Window function enables the display screen to be divided into “windows” each of which can be controlled and displayed independently.

Display Memory is shared by all windows; individual windows do not have their own display memory. There are 2 types of “window”: Base-Window and User-Window. Refer to “Window command group”, page 28.

#### 6.3.1 Base-Window

Base-Window covers the entire display screen. If no User-Windows are defined, all display operation is processed on this window. If one or more User-Windows are defined, display operation on any area not covered by a User-Window is done by selecting Base-Window.

When Base-Window is selected, even if User-Window(s) are defined, all display operation is processed under Base-Window. Therefore the current display contents of User-Window(s) is overwritten.

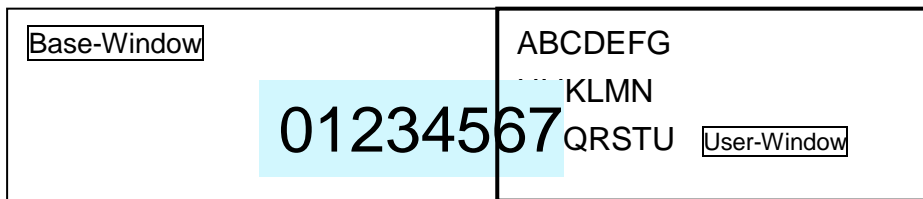

#### 6.3.2 User-Window

User-Window is defined by User-Window definition command. Display operation is processed on the window selected by Current Window select command.

A maximum of 4 User-Windows can be defined.

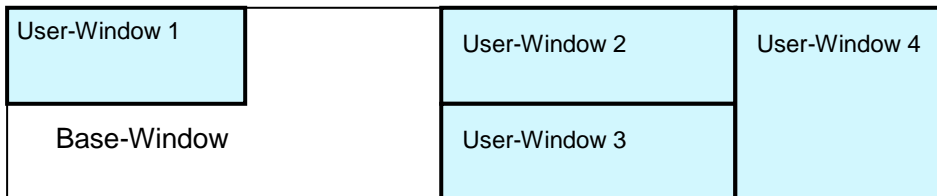

**6.4 Write screen mode**

**This setting is only applicable for Base-Window.**

There are two Write screen modes, Display screen mode and All screen mode. The mode is set by command (refer to Window command group, "Write screen mode select", page 30).

**6.4.1 Display screen mode**

When the cursor is located in the Display area, all operation will be done within Display area, and when cursor is located in the Hidden area, it will be done within Hidden area.

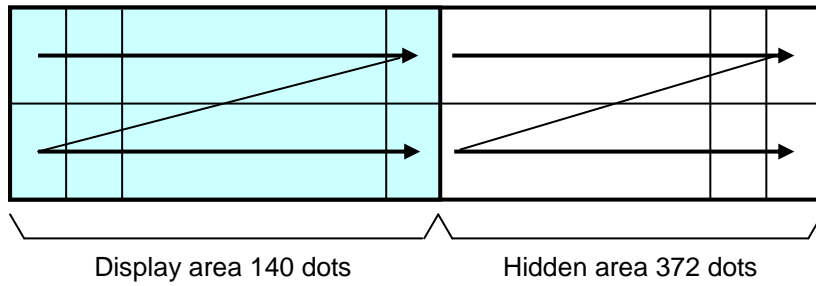

**6.4.2 All screen mode**

Regardless of the cursor position, operation will be done over the entire area.

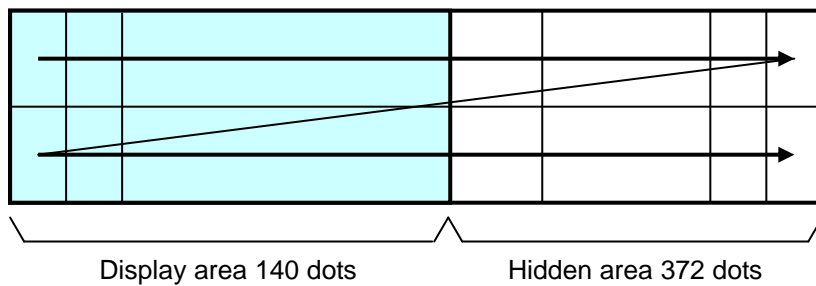

### 6.5 Character display format

Character display format is as follows, as set by “Character display width” command.

Type of character	Display position	Format	Fixed character width 1	Fixed character width 2	Proportional character width 1	Proportional character width 2
Standard character and Download character 5x7dot	Y = 0 (Top line)	Character format	5 x 7	5 x 7	n x 7	n x 7
		Upper space	0	0	0	0
		Lower space	1	1	1	1
		Left space	0	1	0	1
		Right space	1	1	1	1
	Y = 1 (Bottom line)	Character format	5 x 7	5 x 7	n x 7	n x 7
		Upper space	1	1	1	1
		Lower space	0	0	0	0
		Left space	0	1	0	1
		Right space	1	1	1	1
Download character 7x8	Y = 0 (Top line)	Character format	6 x 8 *	7 x 8	6 x 8 *	7 x 8
	Y = 1 (Bottom line)	Upper space	0	0	0	0
		Lower space	0	0	0	0
		Left space	0	0	0	0
		Right space	0	0	0	0

\* The left-most 6x8 dot part of the 7x8 dot character is displayed.

Note: When a proportional character width is specified, the blank character (20h) is treated as a 2-dot width character.

Fixed character width 1

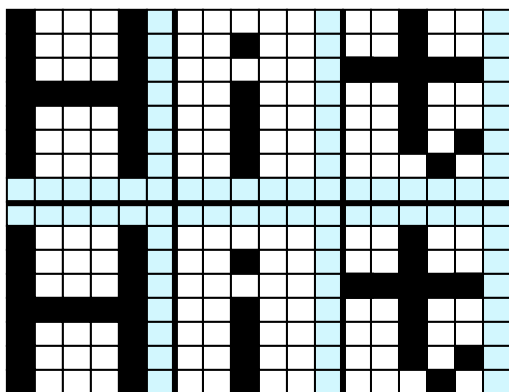

Fixed character width 2

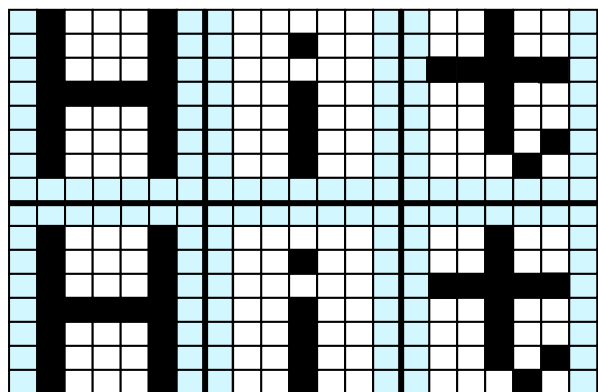

Proportional character width 1

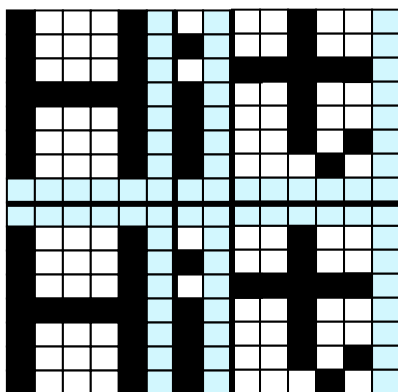

Proportional character width 2

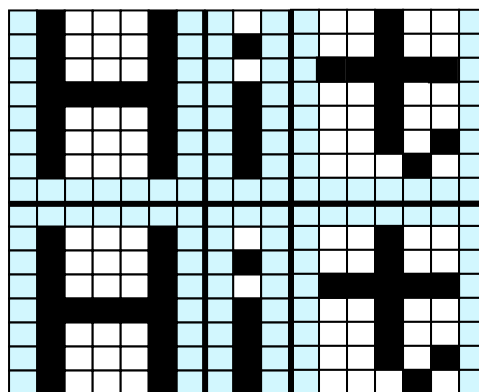

## 7 Function

### 7.1 Commands

This section describes the operation of each command.

Note: The character size (X × Y dot) referred to in this section, depends on the “Character display width” and “Font magnified display” settings.

The number of X dots and Y dots for 1 character for each character display width are as follows:

Character type	Fixed character width 1	Fixed character width 2	Proportional character width 1	Proportional character width 2
Number of X dots	5 + 1	5 + 2	5 + 1	5 + 2
Number of Y dots	7 + 1	7 + 1	7 + 1	7 + 1

MD1 mode, MD2 mode, and MD3 mode, described below, refer to Over-write mode, Vertical scroll mode, and Horizontal scroll mode respectively. (To select the mode, refer to the commands “US MD1”, “US MD2”, and “US MD3”).

#### 7.1.1 Character display

**Code:** 20h – FFh

**Name:** Character display

**Function:** Display character at cursor position.

This command operates on the currently-selected window (refer to Window select).

MD1 (Over-write mode)

Cursor position		Display Operation
X direction	Y direction	
Space for character on right side.	-	Display >> HT
Right end	Space for character in next lower line.	HT >> Display >> HT
	No space for character in next lower line.	HT >> Display >> HT

MD2 (Vertical scroll mode)

Cursor position		Display Operation
X direction	Y direction	
Space for character on right side.	-	Display >> HT
Right end	Space for character in next lower line.	HT >> Display >> HT
	No space for character in next lower line.	HT >> Display >> HT

MD3 (Horizontal scroll mode)

Cursor position		Display Operation
X direction	Y direction	
The space for 1 character size is in right side.	-	Display >> HT
Right end	-	HT >> Display >> HT

### 7.1.2 BS (*Back Space*)

**Code:** 08h

Function: Cursor moves to the left by one character.  
This command has effect for the currently-selected window.

MD1 (Over-write mode) and MD2 (Vertical scroll mode)

Cursor position		Display Operation
X direction	Y direction	
Space for character on left side.	-	Cursor moves left by one character.
Left end	Space for one line above.	Cursor moves to right end of next upper line.
	No space for one line above.	Cursor does not move.

MD3 (Horizontal scroll mode)

Cursor position		Display Operation
X direction	Y direction	
Space for character on left side.	-	Cursor moves left by one character.
Left end	-	Cursor does not move.

### 7.1.3 HT (*Horizontal Tab*) – 1 character to right

**Code:** 09h

Function: Cursor moves to the right by one character.  
This command has effect for the currently-selected window.

MD1 (Over-write mode)

Cursor position		Display Operation
X direction	Y direction	
Space for character on right side.	-	Cursor moves right by one character.
Right end	Space for character in next lower line.	Cursor moves to left end of next lower line.
	No space for character in next lower line.	Cursor moves to left end of top line.

MD2 (Vertical scroll mode)

Cursor position		Display Operation
X direction	Y direction	
Space for character on right side.	-	Cursor moves right by one character.
Right end	Space for character in next lower line.	Cursor moves to left end of next lower line.
	No space for character in next lower line.	Display contents are scrolled up the required number of dots, and the bottom line is cleared. Cursor moves to left end of bottom line.

## MD3 (Horizontal scroll mode)

Cursor position		Display Operation
X direction	Y direction	
Space for character on right side.	-	Cursor moves right by one character.
Right end	-	Contents of current line scroll left until sufficient space for character is available at the right end. Cursor moves to the left edge of newly-created space.

7.1.4 LF (*Line Feed*)

Code: 0Ah

Function: Cursor moves to next lower line.

This command has effect for the currently-selected window.

## MD1 (Over-write mode)

Cursor position		Display Operation
X direction	Y direction	
-	Space for character in next lower line.	Cursor moves to the same position on next lower line.
	No space for character in next lower line.	Cursor moves to the same position on top line.

## MD2 (Vertical scroll mode)

Cursor position		Display Operation
X direction	Y direction	
-	Space for character in next lower line.	Cursor moves to the same position on next lower line.
	No space for character in next lower line.	Display contents are scrolled up the required number of dots, and the bottom line is cleared. Cursor does not move.

## MD3 (Horizontal scroll mode)

Cursor position		Display Operation
X direction	Y direction	
-	-	Cursor does not move.

**7.1.5 HOM (Home Position)****Code: 0Bh**

Function: Cursor moves to home position (top left).  
 This command has effect for the currently-selected window.

**7.1.6 CR (Carriage Return)****Code: 0Dh**

Function: Cursor moves to left end of current line.  
 This command has effect for the currently-selected window.

**7.1.7 US \$ xL xH yL yH (Cursor Set)****Code: 1Fh 24h xL xH yL yH**

xL: Cursor position x, lower byte (1 dot / unit)  
 xH: Cursor position x, upper byte (1 dot / unit)  
 yL: Cursor position y, lower byte (8 dots / unit)  
 yH: Cursor position y, upper byte (8 dots / unit)  
 Definable area:  $0000h \leq (xL + xH \times 100h) \leq 01FFh$   
 $0000h \leq (yL + yH \times 100h) \leq 0001h$

Function: Cursor moves to the specified (X, Y) position on Display Memory.  
 If the specified X, Y position (X and/or Y) is outside the definable area, or outside the currently-selected window, the command is ignored and the cursor remains in the same position.  
 This command has effect for the currently-selected window.

**7.1.8 CLR (Display Clear)****Code: 0Ch**

Function: Display screen is cleared and cursor moves to home position.  
 This command has effect for the currently-selected window.

**7.1.9 US C n (Cursor display)****Code: 1Fh 43h n**

n: Cursor display setting  
 Definable area:  $00h \leq n \leq 01h$   
 n = 00h: Cursor display OFF  
 n = 01h: Cursor display ON

Default: n = 00h (Cursor OFF)  
 Function: Cursor display setting.  
 When cursor display is ON, cursor position appears as reverse blinking, 1×8 dots.  
 When cursor is in hidden area, it does not appear, even when cursor display is set ON.  
 This command has effect for the currently-selected window.

**7.1.10 ESC @ (Initialize Display)****Code: 1Bh 40h**

Settings return to default values.  
 Jumper settings are not re-loaded.  
 Contents of receive buffer remain in memory.



### 7.1.11 ESC % n (*Download character ON/OFF*)

**Code:** 1Bh 25h n

Function: Enable or disable display of download characters.

n = 01h: Enable (If download character is not defined, built-in character is displayed)

n = 00h: Disable

Characters already displayed are not affected.

### 7.1.12 ESC & a c1 c2 [x1 d1...d(axx1)]...[xk d1...d(axxk)] (*Download character definition*)

**Code:** 1Bh 26h a c1 c2 [x1 d1...d(axx1)]...[xk d1...d(axxk)]

a: Select character type

c1: Start character code

c2: End character code

x: Number of dots for X-direction

d: Definition data

Definable area: a = 01h

x = 05h: 5×7 dot

x = 07h: 7×8 dot

20h ≤ c1 ≤ c2 ≤ FFh

00h ≤ d ≤ FFh

x = 05h: Upper 7 bits are valid.

x = 07h: All 8 bits are valid.

k = c2 - c1 + 1

Function: Define download characters into RAM.

A maximum of 16 download characters can be defined.

x = 05h: Defined as 5×7 dot. Surrounding space is same as standard character display.

x = 07h: Defined as 7×8 dot. Displayed as 6×8 or 7×8 dot character (refer to 6.5 "Character display format").

After the maximum number of download characters are defined, in order to define other character codes, space must first be obtained using the Download character delete command.

Downloaded characters are valid until redefined, an initialize (ESC @) sequence is executed, or the power is turned off.

To display download characters the commands Download character definition and Download character ON/OFF (set to ON) are required.

If a currently-displayed download character is re-defined, there is no affect on the currently-displayed character. It is effective only for newly input characters.

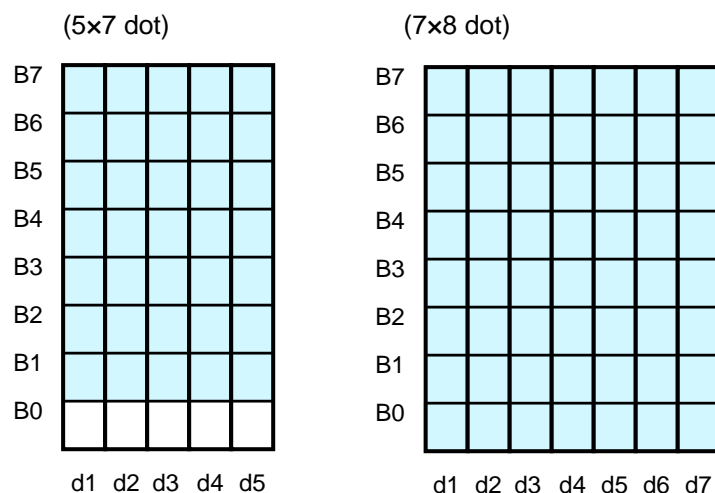

**7.1.13 ESC ? a c (Download character delete)****Code:** 1Bh 3Fh a c

a: Select character type

c: Delete Character code

Definable area: a = 01h  
20h ≤ c ≤ FFh

Function: Delete defined download character.

Built-in character is displayed after download character is deleted.

Characters already displayed are not affected.

Command is ignored if download character is not defined for the given character code.

**7.1.14 ESC R n (International font set)****Code:** 1Bh 52h n

Definable area: 00h ≤ n ≤ 0Dh

Default: n = 00h

Function: Select international font set.

Characters already displayed are not affected.

n	Font set
00h	America
01h	France
02h	Germany
03h	England
04h	Denmark 1
05h	Sweden
06h	Italy
07h	Spain1
08h	Japan
09h	Norway
0Ah	Denmark2
0Bh	Spain2
0Ch	Latin America
0Dh	Korea

**7.1.15 ESC t n (Character table type)****Code:** 1Bh 74h nDefinable area: n = 00h, 01h, 02h, 03h, 04h, 05h, 10h, 11h,  
12h, 13h

Default: n = 00h

Function: Select Character table type.

Characters already displayed are not affected.

n	Font code type
00h	PC437(USA – Euro std)
01h	Katakana – Japanese
02h	PC850 (Multilingual)
03h	PC860 (Portuguese)
04h	PC863 (Canadian-French)
05h	PC865 (Nordic)
10h	WPC1252
11h	PC866 (Cyrillic #2)
12h	PC852 (Latin 2)
13h	PC858

**7.1.16 US MD1 (Over-write mode)****Code:** 1Fh 01h

Function: Display mode set to Over-write mode.

This command has effect for the currently-selected window.

**7.1.17 US MD2 (Vertical scroll mode)****Code:** 1Fh 02h

Function: Display mode set to Vertical scroll mode.

This command has effect for the currently-selected window.

**7.1.18 US MD3 (Horizontal scroll mode)****Code:** 1Fh 03h

Function: Display mode set to Horizontal scroll mode.

This command has effect for the currently-selected window.

**7.1.19 US s n (Horizontal scroll speed)****Code:** 1Fh 73h nDefinable area:  $00 \leq n \leq 1Fh$ 

Default: n = 00h

Function: Set speed for Horizontal scroll mode.

Scroll speed is set by 'n'.

Subsequent commands are not processed until scroll is completed.

Scroll base time period 'T' depends on screen mode and character size, etc.

n	Speed
00h	Instantaneous
01h	T ms / 2 dots
02h – 1Fh	(n-1)×T ms / dot

**7.1.20 US r n (Reverse display)****Code:** 1Fh 72h n

n: Reverse display ON/OFF

Definable area:  $00h \leq n \leq 01h$ 

n = 00h: Reverse OFF

n = 01h: Reverse ON

Default: n = 00h

Function: Reverse display ON/OFF for character and image display.

Changing this setting only affects subsequent data. Content already displayed is not affected.

**7.1.21 US w n (Write mixture display mode)****Code:** 1Fh 77h n

n: Display write mode

Definable area: 00h ≤ n ≤ 03h

n = 00h: Normal display write (not mixture display)

n = 01h: OR display write

n = 02h: AND display write

n = 03h: EX-OR display write

Default: n = 00h

Function: Specifies write mixture mode.

Newly-written characters and images are combined with current display contents in Display Memory.

**7.1.22 US X n (Brightness level setting)****Code:** 1Fh 58h n

n: Brightness level setting

Definable area: 00h ≤ n ≤ 08h

Default: n = 08h

Function: Set display brightness level.

n: Level

01h: 12.5%            02h: 25%

03h: 37.5%           04h: 50%

05h: 62.5%           06h: 75%

07h: 87.5%           08h: 100%

**7.1.23 US ( a n [parameter] (Display action command group)**

Function: Execute processing of display action command.

n	Function No.	Function
01h	Function 01h	Wait
10h	Function 10h	Scroll display action
11h	Function 11h	Blink display action
40h	Function 40h	Screen saver

n: Function code.

Subsequent commands are not processed until display action processing is completed.

**7.1.24 <Function 01h> US ( a 01h t (Wait)****Code:** 1Fh 28h 61h 01h t

t: Wait time

Definable area: 00h ≤ t ≤ FFh

Function: Waits for the specified time (command and data processing is stopped).

Wait time = t × approximately 0.5s

**7.1.25 <Function 10h> US ( a 10h wL wH cL cH s (Scroll display action)**

**Code: 1Fh 28h 61h 10h wL wH cL cH s**

- wL: Display screen shift byte count, lower byte
- wH: Display screen shift byte count, upper byte
- cL: Number of cycles, lower byte
- cH: Number of cycles, upper byte
- s: Scroll speed

Definable area:  $0000h \leq (wL + wH \times 100h) \leq 03FFh$   
 $0001h \leq (cL + cH \times 100h) \leq FFFFh$   
 $00h \leq s \leq FFh$

Function: Shift the display screen.

Horizontal scrolling is possible by specifying as the shift byte count a multiple of (Display screen 'y' dot /8). Display switching is possible by specifying shift byte count as (Display screen 'x' dot x Display screen 'y' dot /8). Scroll speed is specified by 's'.

Scroll speed:  $s \times 14ms$  (approximately) / shift

For example: 1 dot scroll to the left: wL=02h, wH=00h

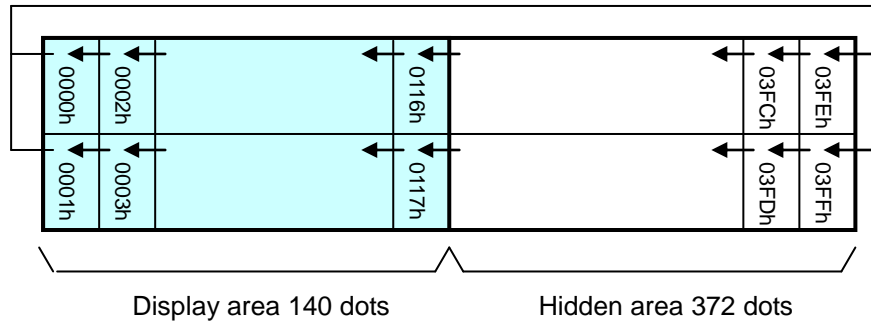

**7.1.26 <Function 11h> US ( a 11h p t1 t2 c (Blink)****Code: 1Fh 28h 61h 11h p t1 t2 c**

p: Blink pattern

t1: Normal display time

t2: Blank or reverse display time

c: Number of cycles

Definable area: 00h ≤ p ≤ 02h

p = 00h: Normal display.

p = 01h: Blink display (alternately Normal and Blank display).

p = 02h: Blink display (alternately Normal and Reverse display).

01h ≤ t1 ≤ FFh

01h ≤ t2 ≤ FFh

00h ≤ c ≤ FFh

Function: Blink display action Blink pattern specified by 'p'.

Time is specified by 't1' and 't2'

A: t1 × 14ms (approximately) Normal display

B: t2 × 14ms (approximately) Blank or Reverse display

Repeated 'c' times.

This command does not affect Display Memory.

c=00h: Blink continues during subsequent command and data processing, until c=01h–FFh is set, or Initialize command.

c=01h – FFh: Blink display is repeated 1–255 times while command and data processing is stopped.

After display blinking is completed, Normal display returns and command and data processing resumes. Command / data processing does not resume until operation is completed.

**7.1.27 <Function 40h> US ( a 40h p (Screen saver)****Code: 1Fh 28h 61h 40h p**

p: Screen saver mode

Definable area: 00h ≤ p ≤ 04h

p = 00h: Display power OFF (Power save mode)

p = 01h: Display power ON

p = 02h: All dot OFF

p = 03h: All dot ON

p = 04h: Repeat blink display with normal and Reverse display

(Normal: 2s, Reverse: 2s)

Function: Control Power ON or OFF, and Start Screen saver mode.

p = 00h – 01h: Control Power ON or OFF. This setting is applied until this command is re-specified.

p = 02h – 04h: Start Screen saver mode. This setting is cancelled when next data is input.

**7.1.28 US ( f n [parameter] (Bit image display group)**

Function: Display bit image data.

n	Function No.	Function
11h	Function 11h	Real-time bit image display

n: Function code.

**7.1.29 <Function 11h> US ( f 11n xL xH yL yH g d(1)...d(k) (Real-time bit image display)**

**Code:** 1Fh 28h 66h 11h xL xH yL yH g d(1)...d(k)

xL: Bit image X size, lower byte (by 1 dot)

xH: Bit image X size, upper byte (by 1 dot)

yL: Bit image Y size, lower byte (by 8 dots)

yH: Bit image Y size, upper byte (by 8 dots)

g: Image information = 1 (fixed)

d(1)–d(k): Bit Image data (see below)

Definable area:  $0001h \leq (xL + xH \times 100h) \leq 0200h$

$0001h \leq (yL + yH \times 100h) \leq 0002h$

$g = 01h$

$k = x \times y \times g$

$00h \leq d \leq FFh$

Function: Display the bit image data at the cursor position in real-time.

Cursor position does not change.

If bit image exceeds the bounds of the current window, only the portion within the currently-selected window is displayed.

If Display position or display size etc, are outside the definable area, the command is cancelled at the point where the error is detected, and the remaining data is treated as standard data.

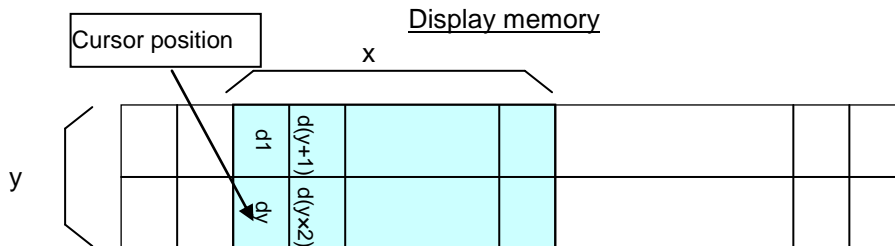

### 7.1.30 US ( d n [parameter] (Dot unit command group)

Function: Dot unit display bit image data or character.

n	Function No.	Function
20h	Function 20h	Dot unit downloaded bit image display
21h	Function 21h	Dot unit real-time bit image display
30h	Function 30h	Dot unit character display

n: Function code.

### 7.1.31 <Function 20h> US ( d 20h xPL xPH yPL yPH m aL aH aE ySL ySH xOL xOH yOL yOH xL xH yL yH g (Dot unit downloaded bit image display)

Code: 1Fh 28h 64h 20h xPL xPH yPL yPH m aL aH aE ySL ySH xOL xOH yOL yOH xL xH yL yH g

xPL: Display position x, lower byte (by 1 dot)  
 xPH: Display position x, upper byte (by 1 dot)  
 yPL: Display position y, lower byte (by 1 dot)  
 yPH: Display position y, upper byte (by 1 dot)  
 m: Image data display memory select  
 aL: Bit image data definition address, lower byte  
 aH: Bit image data definition address, upper byte  
 aE: Bit image data definition address, extension byte  
 ySL: Bit image defined, Y size, lower byte (by 8 dots)  
 ySH: Bit image defined, Y size, upper byte (by 8 dots)  
 xOL: Image data offset x, lower byte (by 1 dot)  
 xOH: Image data offset x, upper byte (by 1 dot)  
 yOL: Image data offset y, lower byte (by 1 dot)  
 yOH: Image data offset y, upper byte (by 1 dot)  
 xL: Bit image display X size, lower byte (by 1 dot)  
 xH: Bit image display X size, upper byte (by 1 dot)  
 yL: Bit image display Y size, lower byte (by 1 dot)  
 yH: Bit image display Y size, upper byte (by 1 dot)  
 g: Image information = 1 (fixed)

Definable area:  $0000h \leq (xPL + xPH \times 100h) \leq 01FFh$   
 $0000h \leq (yPL + yPH \times 100h) \leq 000Fh$   
 m = 02h: Display Memory bit image

#### Display Memory bit image

$(aL + aH \times 100h + aE \times 10000h) = 000000h$   
 $(ySL + ySH \times 100h) = 0000h$   
 $0000h \leq (xOL + xOH \times 100h) \leq 01FFh$   
 $0000h \leq (yOL + yOH \times 100h) \leq 000Fh$   
 $0001h \leq (xL + xH \times 100h) \leq 0200h$   
 $0001h \leq (yL + yH \times 100h) \leq 0010h$

Function: Display the bit image defined in Display Memory at the specified (x,y) position. Display position, display size, and image data offset are specified in unit of 1 dot. If bit image exceeds the bounds of the current window, only the portion within the currently-selected window is displayed. If Display position or image size, etc are outside the definable area, the command is cancelled at the point where the error is detected, and the remaining data is treated as standard data.



**7.1.32 <Function 21h> US ( d 21h xPL xPH yPL yPH xL xH yL yH g d(1)...d(k) (Dot unit real-time bit image display)**

**Code:** 1Fh 28h 64h 21h xPL xPH yPL yPH xL xH yL yH g d(1)...d(k)

- xPL: Display position x, lower byte (by 1 dot)
- xPH: Display position x, upper byte (by 1 dot)
- yPL: Display position y, lower byte (by 1 dot)
- yPH: Display position y, upper byte (by 1 dot)
- xL: Bit image display X size, lower byte (by 1 dot)
- xH: Bit image display X size, upper byte (by 1 dot)
- yL: Bit image display Y size, lower byte (by 1 dot)
- yH: Bit image display Y size, upper byte (by 1 dot)
- g: Display information = 1 (fixed)
- d(1)–d(k): Bit image data (see below)

**Definable area:** 0000h ≤ (xPL + xPH×100h) ≤ 01FFh  
 0000h ≤ (yPL + yPH×100h) ≤ 000Fh  
 0001h ≤ (xL + xH×100h) ≤ 0200h  
 0001h ≤ (yL + yH×100h) ≤ 0010h  
 g = 01h  
 00h ≤ d ≤ FFh

**Function:** Display the bit image data at the specified (x,y) position in real-time.  
 Display position and display size are specified in units of 1 dot.  
 If bit image exceeds the bounds of the current window, only the portion within the currently-selected window is displayed.  
 If Display position or display size are outside the definable area, the command is cancelled at the point where the error is detected, and the remaining data is treated as standard data.

Example: xP=2, yP=1, Display size x=8, y=14

Image data

b7	d1	d3	d5	d7	d9	d11	d13	d15
b6								
b5								
b4								
b3								
b2								
b1								
b0								
b7	d2	d4	d6	d8	d10	d12	d14	d16
b6								
b5								
b4								
b3								
b2								
b1								
b0								

Display Memory

		x=8											
				xP									
		0	1	2	3	4	5	6	7	8	9	10	11
yP	0												
	1			d1	d3	d5	d7	d9	d11	d13	d15		
	2												
	3												
	4												
	5												
	6												
	7												
	8												
	9			d2	d4	d6	d8	d10	d12	d14	d16		
	10												
	11												
	12												
	13												
	14												
15													

**7.1.33 <Function 30h> US ( d 30h xPL xPH yPL yPH m bLen d(1)...d(bLen) (Dot unit character display)**

**Code:** 1Fh 28h 64h 30h xPL xPH yPL yPH m bLen d(1)...d(bLen)

xPL: Display position x, lower byte (by 1 dot)

xPH: Display position x, upper byte (by 1 dot)

yPL: Display position y, lower byte (by 1 dot)

yPH: Display position y, upper byte (by 1 dot)

m: -

bLen: Character data length

d(1)–d(bLen): Character data / reverse select

Definable area: 0000h ≤ (xPL + xPH×100h) ≤ 01FFh, FFFFh

0000h ≤ (yPL + yPH×100h) ≤ 000Fh

m = 00h

00h ≤ bLen ≤ FFh

00h ≤ d ≤ FFh

d=10h: Reverse OFF

d=11h: Reverse ON

Function: Display the specified text characters at the specified (x,y) position.

Display position is specified in units of 1 dot.

For display position xP=FFFFh, write position continues from previous writes done using this command.

The current settings for character size and table type, etc are used.

Character magnification and bold settings are not used.

If character display exceeds the bounds of the current window, only the portion within the currently-selected window is displayed.

If Display position is outside the definable area, the command is cancelled at the point where the error is detected, and the remaining data is treated as standard data.

Example: Display position xP=2, yP=3, 6×8 dot character "AB"

Display Memory

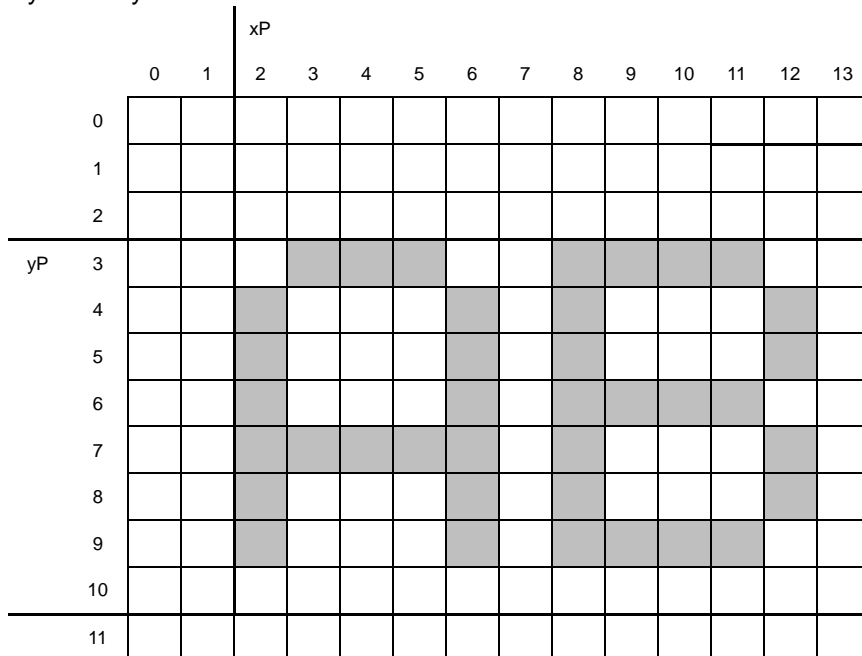

**7.1.34 US ( g n [parameter] (Font command group)**

Function: Font Width and Font Magnification settings.

n	Function No.	Function
03h	Function 03h	Font Width
40h	Function 40h	Font Magnification

n: Function code.

**7.1.35 <Function 03h> US ( g 03h w (Font Width)**

Code: 1Fh 28h 67h 03h w

w: Font width setting

Definable area:  $00h \leq w \leq 03h$

w = 00h: Fixed character width 1 (1 dot space on right side)

w = 01h: Fixed character width 2 (1 dot space on right side and left side)

w = 02h: Proportional character width 1 (1 dot space on right side)

w = 03h: Proportional character width 2 (1 dot space on right side and left side)

Default: w = 01h

Function: Sets the character width.

Fixed character width 1 & 2: Character is written with fixed character width (6 or 7 dot).

Proportional character width: Character is written with proportioned character width.

**7.1.36 <Function 40h> US ( g 40h x y (Font Magnification)**

Code: 1Fh 28h 67h 40h x y

x: X magnification factor

y: Y magnification factor

Definable area:  $01h \leq x \leq 04h$

$01h \leq y \leq 02h$

Default: x = 01h

y = 01h

Function: Set character magnification 'x' times to the right and 'y' times downward.

Character magnification includes the space specified by Font Width command.

(x=1, y=1)

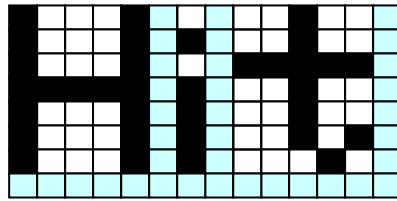

(x=2, y=2)

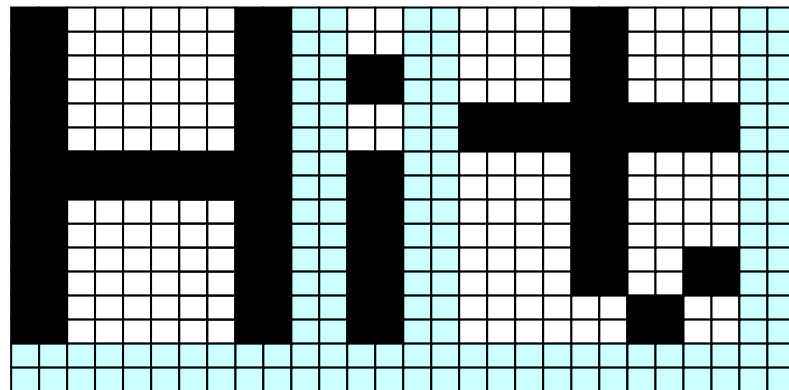

**7.1.37 US ( w n [parameter] (Window command group)**

Function: Window / screen commands

n	Function No.	Function
01h	Function 01h	Current window select
02h	Function 02h	User-Window definition and cancel
10h	Function 10h	Write screen mode select

n: Function code.

**7.1.38 <Function 01h> US ( w 01h a (Window select)**

**Code: 1Fh 28h 77h 01h a**

a: Window number  
 a = 00h: Base-Window  
 a = 01h – 04h: User-Window

Definable area: 00h ≤ a ≤ 04h

Function: Select current window.

Command is ignored if Window number is for a User-Window that is not defined.

**7.1.39 <Function 02h> US ( w 02h a b [xPL xPH yPL yPH xSL xSH ySL ySH]**

**(User Window define / cancel)**

**Code: 1Fh 28h 77h 02h a b [xPL xPH yPL yPH xSL xSH ySL ySH]**

- a: Definable window No. No. 1 – 4
  - b: Define or Cancel b = 00h: Cancel, b = 01h: Define
  - xPL: Left position of window x, lower byte (by 1 dot)
  - xPH: Left position of window x, upper byte (by 1 dot)
  - yPL: Top position of window y, lower byte (by 8 dot)
  - yPH: Top position of window y, upper byte (by 8 dot)
  - xSL: X size of window, lower byte (by 1 dot)
  - xSH: X size of window, upper byte (by 1 dot)
  - ySL: Y size of window, lower byte (by 8 dot)
  - ySH: Y size of window, upper byte (by 8 dot)
- Definable area: 01h ≤ a ≤ 04h  
 00h ≤ b ≤ 01h  
 0000h ≤ (xPL + xPH×100h) ≤ 01FFh  
 0000h ≤ (yPL + yPH×100h) ≤ 0001h  
 0001h ≤ (xSL + xSH×100h) ≤ (0200h - (xPL + xPH×100h))  
 0001h ≤ (ySL + ySH×100h) ≤ (0002h - (yPL + yPH×100h))

Function: Define or cancel User-Window

Display contents are not changed by this command.

User-Window define (b = 01h):

Specify User-Window number, window position, and window size. Window position and Window size are specified in units of one block (1×8 dot).

Up to 4 User-Windows can be defined.

The cursor position for the window is initialized to top left (X=0, Y=0).

User-Window cancel (b = 00h):

For User-Window cancel, window range parameters [xPL – ySH] are not used.

If the currently-selected window is cancelled, the Base-Window becomes the currently-selected window.

If any of 'a', 'b', 'xP', 'yP', 'xS', or 'yS' are outside the definable area, the command is cancelled at that point and the following data is treated as standard data.

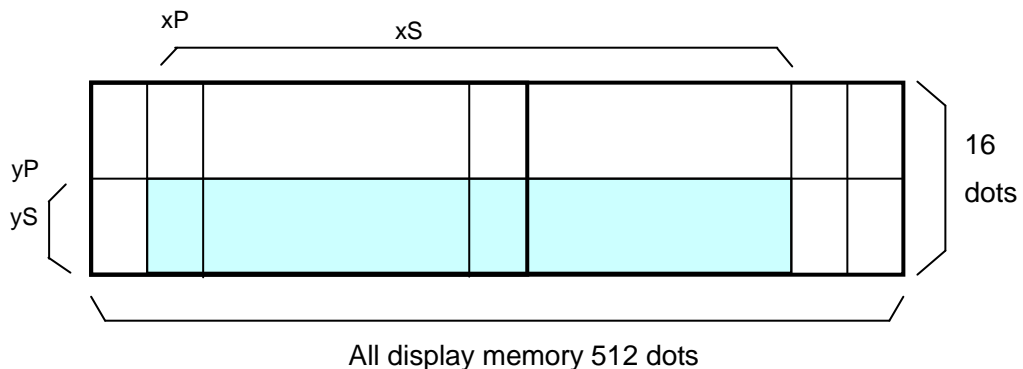

#### 7.1.40 <Function 10h> US ( w 10h a (Write screen mode select)

Code: 1Fh 28h 77h 10h a

a: Write screen mode  
 a = 00h: Display screen mode  
 a = 01h: All screen mode

Definable area: 00h ≤ a ≤ 01h

Default: a = 00h

Function: Select the write screen mode. **This setting is only applicable for Base-Window.**

Display screen mode: Display action is valid within area of either Display area or Hidden area, depending on cursor position.

All screen mode: Display action is valid over the entire display memory.

For details, refer to 6.4 Write screen mode.

#### 7.1.41 WINx (Window select shortcut)

Function: Select current window (1-byte command).

Refer to 7.1.38 for more detail.

WINx	Function
WIN0 (10h)	Select Base-Window
WIN1 (11h)	Select User-Window 1
WIN2 (12h)	Select User-Window 2
WIN3 (13h)	Select User-Window 3
WIN4 (14h)	Select User-Window 4

## 7.2 Bit image data format

The Bit image consists of the data for image size (x x y) as follows;

Data	Pattern position
d (1)	P1
d (2)	P2
d (x x y)	P(x x y)

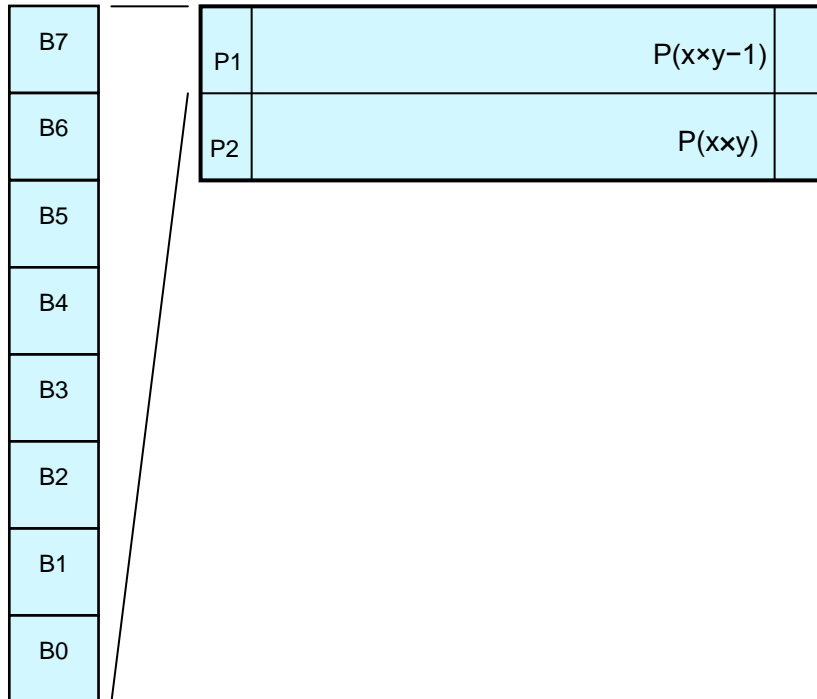



8 Setup

8.1 Jumper

No.	Function	Default
J0	Baud Rate select	OPEN
J1		OPEN
J2	Reserved (do not change)	OPEN
J3		OPEN
JRB	Parallel interface through-holes Pin #3 signal setting	OPEN

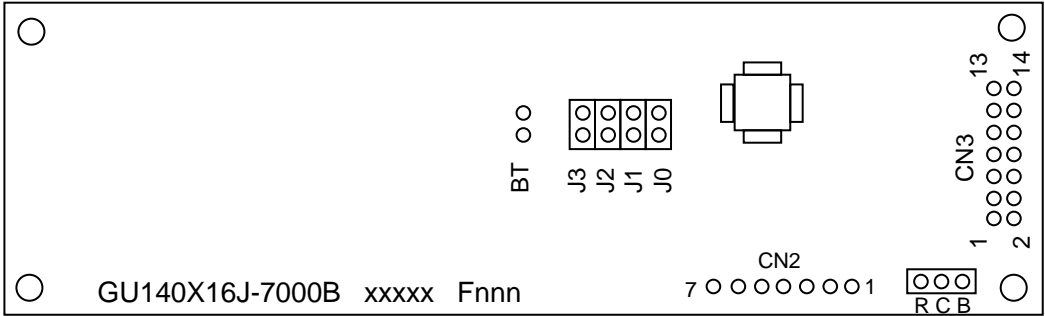

Note: "BT" is for factory use only.

8.1.1 Baud rate setting (for serial interface)

J0	J1	Baud rate
OPEN	OPEN	38,400bps
SHORT	OPEN	19,200bps
OPEN	SHORT	9,600bps
SHORT	SHORT	115,200bps

8.1.2 Parallel interface through-holes Pin #3 signal setting

JRB	Signal of Pin#3
OPEN	NC
C-R SHORT	/RESET (Input)
C-B SHORT	PBUSY (Output)
R-C-B SHORT	Do not use.

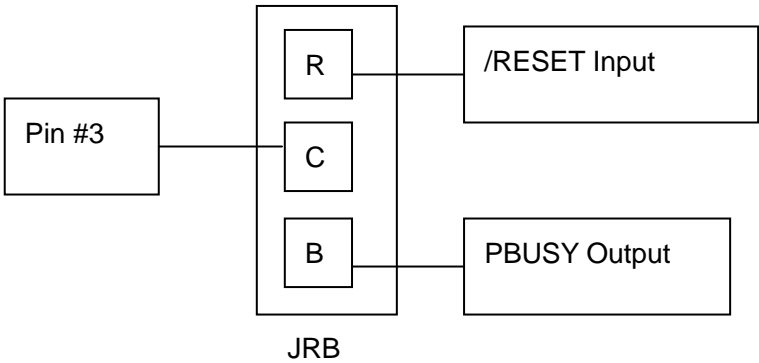

## 9 Connector

### 9.1 Parallel interface 14 through-holes (CN3)

Pin No.	Signal name	Function	Direction	Pin No.	Signal name	Function	Direction
1	GND	Ground	Input	8	D1	Data input	Input/output
2	V <sub>CC</sub>	Power supply	Input	9	D2	Data input	Input/output
3	NC *1	No connection	-	10	D3	Data input	Input/output
4	RS *2	Switch signal	Input	11	D4	Data input	Input/output
5	/WR	Data write	Input	12	D5	Data input	Input/output
6	/RD	Data read	Input	13	D6	Data input	Input/output
7	D0	Data input	Input/output	14	D7(PBUSY)	Data input	Input/output

\* 1: Pin #3 can be changed to /RESET or PBUSY terminal, selected by jumper.

\* 2: Factory use only.

### 9.2 Serial interface 7 through-holes (CN2)

Pin No.	Signal name	Function	Direction
1	V <sub>CC</sub>	Power supply	Input
2	SIN	Data receive	Input
3	GND	Ground	Input
4	SBUSY	Display busy	Output
5	NC	No connection	-
6	/RESET	Reset	Input
7	NC	No connection	-

## 10 Firmware Version Notation

The firmware version is written in the following position.

Soldering Side

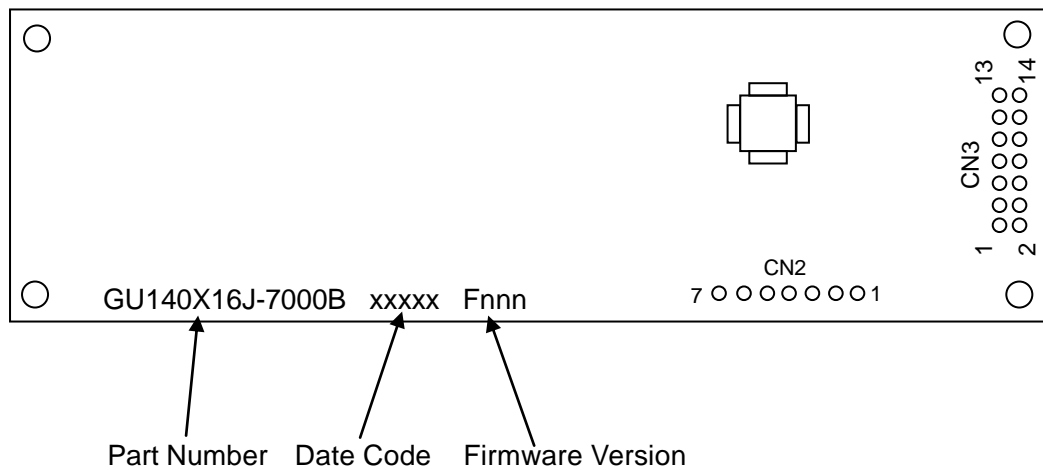

11 Outline Drawing

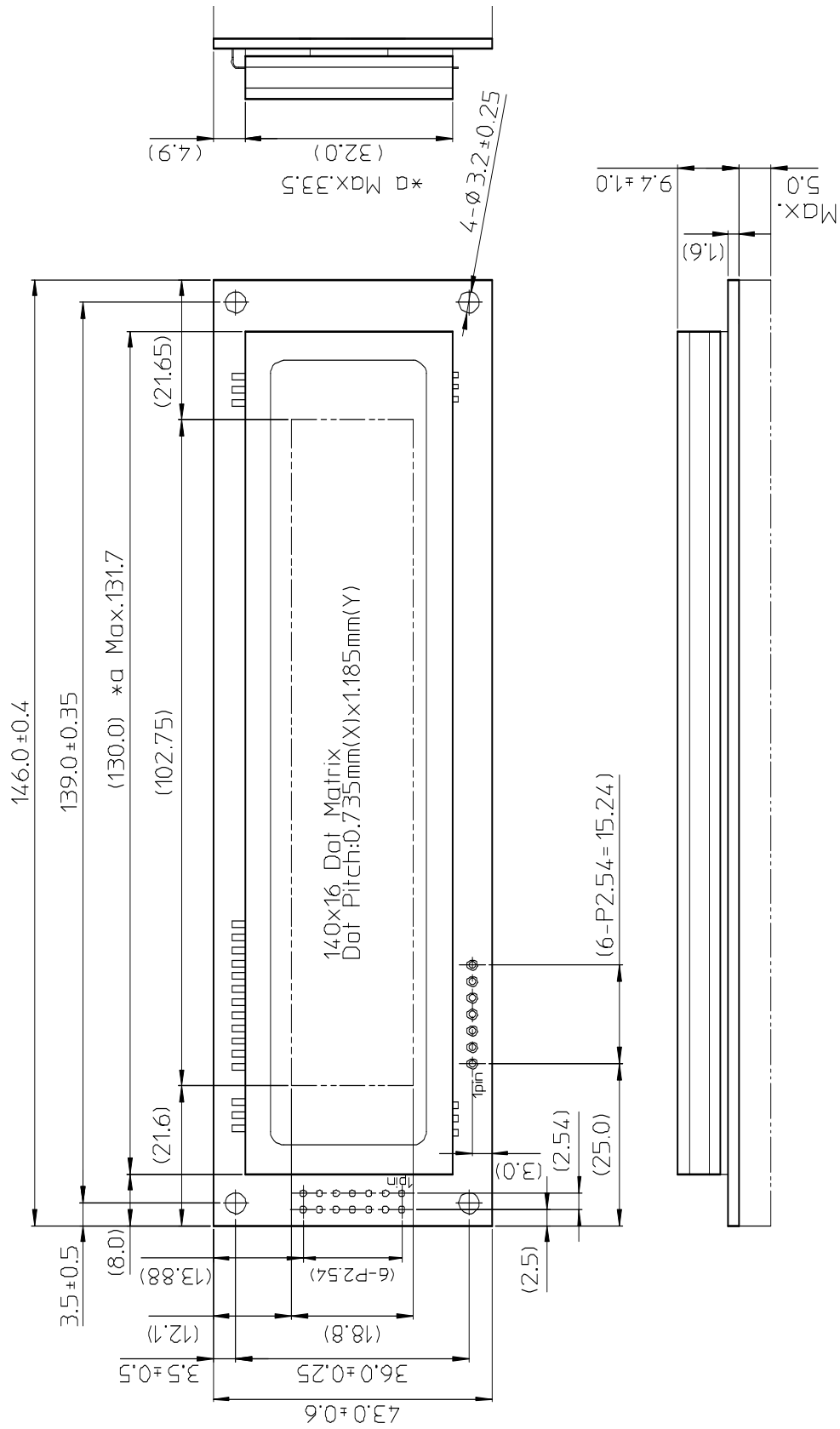

DS-1711-0100-00

## Notice for the Cautious Handling of VFD Modules

### Handling and Usage Precautions:

Please carefully follow the appropriate product application notes and operation standards for proper usage, safe handling, and maximum performance.

#### [VFD tubes are made of glass]

- The edges of the VFD glass envelope are not smooth, so it is necessary to handle carefully to avoid injuries to hands.
- Use caution to avoid breaking the VFD glass envelope, to prevent injury from sharp glass particles.
- The tip of the exhaust pipe is fragile so avoid shock from impact.
- It is recommended to allow sufficient open space surrounding the exhaust pipe to avoid possible damage.
- Please design the PCB for the VFD module within 0.3 mm warping tolerance to avoid any forces that may damage the display due to PCB distortion causing a breakdown of the electrical circuit leading to VFD failure.

#### [High voltage]

- Avoid touching conductive electrical parts, because the VFD module uses high voltage exceeding 30 – 100 volts.
- Even when electric power is turned off, it may take more than one minute for the electrical current to discharge.

#### [Cable connection]

- Do not unplug the power and/or data cables of VFD modules during operation, because unrecoverable damage may result.
- Sending input signals to the VFD module when not powered can cause I/O port damage.
- It is recommended to use a 30cm or shorter signal cable to prevent functional failures.

#### [Electrostatic charge]

- VFD modules need electrostatic-free packaging and protection from electrostatic charges during handling and usage.

#### [Structure]

- During operation, VFD and VFD modules generate heat. Please consider sufficient heat radiation dissipation using heat sink solutions.
- Preferably, use UL-grade materials or components in conjunction with VFD modules.
- Warp and twist movement causes stress and may break VFDs and VFD modules. Please adhere to allowances within 0.3mm at the point of attachment.

#### [Power]

- Apply regulated power to the VFD module within specified voltages to protect from failures.
- VFD modules may draw in-rush current exceeding twice the typical current at power-on, so a power supply with sufficient capacity and quick starting of the power regulator is recommended.
- VFD module needs a specified voltage at the point of connection. Please use an adequate power cable to avoid a decrease in voltage. As a safety measure, a fuse or other over-current protection is recommended.

#### [Operating consideration]

- Illuminating phosphor will decrease in brightness during extended operation. If a fixed pattern illuminates for an extended period (several hours), the phosphor efficiency will decrease compared to the non-operating phosphor, causing non-uniform brightness. Please consider programming the display patterns to use all phosphor segments evenly. Scrolling may be a consideration for a period of time to refresh the phosphor condition and improve even illumination of the pixels.
- A signal cable 30cm or less is recommended to avoid possible disturbances to the signal.

#### [Storage and operating environment]

- Please use VFD modules under the recommended specified environmental conditions. Salty, sulfuric and dusty environments may damage the VFD module even during storage.

#### [Disposal]

- VFD uses lead-containing materials (RoHS directive exempts these lead compounds in the glass for electronic devices). When discarding VFDs or VFD modules, please adhere to applicable laws and regulations.

#### [Other cautions]

- Although the VFD module is designed to be protected from electrical noise, please plan your circuitry to exclude as much noise as possible.
- Do not reconstruct or repair the VFD module without our authorization. We cannot assure the quality or reliability of unauthorized reconstructed VFD modules.

#### Notice:

- We do not authorize the use of any patents that may be inherent in these specifications.
- Neither whole nor partial copying of these specifications is permitted without our approval. If necessary, please ask for assistance from our sales consultant.
- This product is not designed for military, aerospace, medical or other life-critical applications. If you choose to use this product for these applications, please ask us for prior consultation or we cannot accept responsibility for problems that may occur.

MBBZ-009-S18A

**Revision Note**

Specification No.	Date	Revision
DS-1711-0000-00	Nov. 29, 2011	Initial issue
DS-1711-0000-01	Apr. 27, 2012	This product has been corresponded to the RoHS2011. <b>"RoHS2002/95/EC" → "RoHS2011/65/EU"</b> at cover.  4 Environmental Specifications The storage conditions of -40 to -60 °C has been appended. <b>(-60 to -40 °C in less than 168 hours.)</b>  In addition, the correction of errors etc..