

HF-LPC100

Wi-Fi/Bluetooth Module User Manual

V 1.0



Overview of Characteristic

- ✧ Support 802.11b/g Wireless Standard, STA Mode
- ✧ Support Bluetooth 2.1+EDR Standard
- ✧ Support Bluetooth SmartLink
- ✧ Cost Effective Solution With High-Flying MCU
- ✧ Support UART/GPIO Data Communication Interface
- ✧ Support Wireless/Remote Firmware Upgrade
- ✧ Provide SDK for Application develop
- ✧ Support Internal/External Antenna Option
- ✧ Smallest Size: 23.1mm x 32.8mm x (3.45±0.3)mm
- ✧ Wide Input Voltage: 3.3V~ 4.2V
- ✧ FCC/CE Certificated

TABLE OF CONTENTS

LIST OF FIGURES	5
LIST OF TABLES	6
HISTORY	7
1. PRODUCT OVERVIEW	8
1.1. General Description	8
1.2. Device Features	8
1.3. Device Parameters	9
1.4. Key Application	9
1.5. Hardware Introduction	10
1.5.1. Pin Definition.....	10
1.5.2. Electrical Characteristic.....	12
1.5.3. Mechanical Size.....	13
1.5.4. On-board Chip Antenna.....	14
1.5.5. External Antenna.....	14
1.5.6. Evaluation Kit.....	15
1.5.7. Order Information.....	16
1.6. Typical Application	17
1.6.1. Hardware Typical Application.....	17
1.7. Bluetooth Sonic Configuration	18
2. FUNCTION DESCRIPTION	19
2.1. Wireless Networking	19
2.2. Work mode: Transparent Transmission Mode	19
2.3. UART Frame Scheme	20
2.3.1. UART Free-frame.....	20
2.3.2. UART Auto-Frame.....	20
2.4. Bluetooth Function	21
2.5. Firmware Upgrade	21
2.6. GPIO/PWM Function(TBD)	23
2.7. Double SOCKET Communication Function	23
3. AT INSTRUCTION INTRODUCTION	25
3.1. Configuration Mode	25
3.1.1. Switch to Configuration Mode.....	25
3.2. AT+ Instruction Set Overview	26
3.2.1. Instruction Syntax format.....	26
3.2.2. At+ Instruction set.....	27
3.2.2.1. AT+E.....	29
3.2.2.2. AT+ENTM.....	30
3.2.2.3. AT+TMODE.....	30
3.2.2.4. AT+MID.....	30
3.2.2.5. AT+VER.....	30

3.2.2.6.	AT+LVER	31
3.2.2.7.	AT+RELD	31
3.2.2.8.	AT+FCLR	31
3.2.2.9.	AT+Z.....	31
3.2.2.10.	AT+H	31
3.2.2.11.	AT+CFGRD	31
3.2.2.12.	AT+CFGWR	32
3.2.2.13.	AT+CFGFR.....	32
3.2.2.15.	AT+UART	32
3.2.2.16.	AT+UARTF	33
3.2.2.17.	AT+UARTFT.....	33
3.2.2.18.	AT+UARTFL.....	33
3.2.2.19.	AT+UARTTE.....	34
3.2.2.20.	AT+SEND	34
3.2.2.21.	AT+RECV	34
3.2.2.22.	AT+PING	34
3.2.2.23.	AT+NETP	35
3.2.2.24.	AT+MAXSK	35
3.2.2.25.	AT+TCPLK	36
3.2.2.26.	AT+TCPTO.....	36
3.2.2.27.	AT+TCPDIS.....	36
3.2.2.28.	AT+SOCKB	37
3.2.2.29.	AT+TCPDISB	37
3.2.2.30.	AT+TCPTOB	38
3.2.2.31.	AT+TCPLKB.....	38
3.2.2.32.	AT+UDPLCPT	38
3.2.2.33.	AT+SNDB	38
3.2.2.34.	AT+RCVB	39
3.2.2.35.	AT+WSSSID.....	39
3.2.2.36.	AT+WSKEY	39
3.2.2.37.	AT+WANN	40
3.2.2.38.	AT+WSMAC	40
3.2.2.39.	AT+BTMAC	40
3.2.2.40.	AT+WSLK.....	41
3.2.2.41.	AT+WSLQ	41
3.2.2.42.	AT+WSCAN.....	41
3.2.2.43.	AT+WSDNS.....	42
3.2.2.44.	AT+UPURL.....	42
3.2.2.45.	AT+UPFILE	42
3.2.2.46.	AT+LOGSW.....	42
3.2.2.47.	AT+LOGPORT	43
3.2.2.48.	AT+UPST	43
3.2.2.49.	AT+MSLP	43
3.2.2.50.	AT+NTPRF	44

3.2.2.51.	AT+NTPEN.....	44
3.2.2.52.	AT+NTPTM.....	44
3.2.2.53.	AT+NTPSER	45
3.2.2.54.	AT+WRMID	45
3.2.2.55.	AT+RLDEN.....	45
3.2.2.56.	AT+ASWD	45
3.2.2.57.	AT+MDCH	46
3.2.2.58.	AT+TXPWR.....	46
3.2.2.59.	AT+SMTLK.....	46
3.2.2.60.	AT+LPTIO.....	47
4.	PACKGAE INFORMATION.....	48
4.1.	Recommend Reflow Profile	48
4.2.	Device Handling Instruction (Module IC SMT Preparation).....	48
4.3.	Shipping Information	49
	APPEENDIX A: HARD REFERENCE DESIGN.....	50
	APPENDIX B: CONTROL GPIO、PWM FUNCTION WITH NETWORK COMMAND(TBD)....	51
B.1	Network Command	51
B.2	Hexadecimal Network Command	54
	APPENDIX C: HTTP PROTOCOL TRANSFER.....	57
C.1.	HTTP AT Command	57
C.1.1.	AT+HTTPURL.....	57
C.1.2.	AT+HTTPTP	57
C.1.3.	AT+HTTTPH.....	57
C.1.4.	AT+HTTPCN.....	58
C.1.5.	AT+HTTPUA.....	58
C.1.6.	AT+HTTPTD	58
C.2.	HTTP Example.....	58
	APPENDIX D: BLUETOOTH ONE-KEY CONFIGURATION.....	60
	APPENDIX E: HF-LPX SERIES MODULE PIN COMPATIBLE TABLE.....	64
	APPENDIX F: CONTACT INFORMATION.....	65

LIST OF FIGURES

Figure 1.	HF-LPC100 View.....	10
Figure 2.	HF-LPC100 Pins map	10
Figure 3.	HF-LPC100 Mechanical Dimension	13
Figure 4.	HF-LPC100 PCB symbol size	13
Figure 5.	HF-LPC100 module placement region	14
Figure 6.	HF-LPC100 Evaluation Kit(TBD).....	15
Figure 7.	HF-LPC100 order information	16
Figure 8.	HF-LPC100 hardware typical application	17
Figure 9.	Basic HF-LPC100 wireless networking structure	19
Figure 10.	Double Socket setting view.....	24
Figure 11.	HF-LPC100 Default UART parameter	25
Figure 12.	Switch to configuration mode.....	25
Figure 13.	"AT+H" instruction for help.....	26
Figure 14.	Reflow soldering profile	48
Figure 15.	Shipping information	49

LIST OF TABLES

Table 1	HF-LPC100 Module Technical Specifications	9
Table 2	HF-LPC100 Pins Definition	10
Table 3	Electrical Characteristic	12
Table 4	Power Supply & Power Consumption	12
Table 5	HF-LPC100 External Antenna Parameter	14
Table 6	HF-LPC100 Evaluation kit interface description	15
Table 8	HF-LPC100 GPIO/PWM Pin mapping table	23
Table 10	Error Code Description	27
Table 11	AT+ Instruction Set List	27
Table 12	reflow soldering parameter	48

HISTORY

V 1.0 12-05-2014. First version

High-Flying

1. PRODUCT OVERVIEW

1.1. General Description

HF-LPC100 is an embedded Wi-Fi /BT module, which provides a wireless interface to any equipment with a UART or other interface for data transmission. It integrates MAC, baseband processor, RF transceiver with power amplifier in hardware and Wi-Fi/BT protocol and configuration functionality and network TCP/IP stack, in embedded firmware to make a fully self-contained 802.11b/g Wi-Fi solution for a variety of applications.

HF-LPC100 employs the world's lowest power consumption embedded architecture. It has been optimized for all kinds of client applications in the home automation, smart grid, handheld device, personal medical application and industrial control that have lower data rates, and transmit or receive data on an infrequent basis.

The HF-LPC100 integrates all Wi-Fi functionality into a low-profile, 23.1x32.8x (3.45±0.3)mm SMT module package that can be easily mounted on a main PCB with application-specific circuits. Also, the module provides built-in antenna, external antenna option.

1.2. Device Features

- Support 802.11b/g Wireless Standard, STA Mode
- Support Bluetooth 2.1+EDR Standard
- Support SmartLink Function by Bluetooth (Provide IOS/Android APP Lib)
- Cost Effective Solution With High-Flying MCU
- Support UART/GPIO Data Communication Interface
- Support Wireless/Remote Firmware Upgrade
- Provide SDK for Application Development
- Support Internal/External Antenna Option
- Smallest Size: 23.1mm x 32.8mm x (3.45±0.3)mm
- Wide Input Voltage: 3.3V~ 4.2V
- FCC/CE Certificated

1.3. Device Parameters

Table 1 HF-LPC100 Module Technical Specifications

Class	Item	Parameters
Wireless Parameters	Certification	FCC/CE
	Wireless standard	802.11 b/g, 802.15.2
	Frequency range	2.412GHz-2.484GHz
	Transmit Power	802.11b: +16 +/-2dBm (@11Mbps)
		802.11g: +14 +/-2dBm (@54Mbps)
	Receiver Sensitivity	802.11b: -93 dBm (@11Mbps ,CCK)
		802.11g: -85 dBm (@54Mbps, OFDM)
Antenna Option	External:I-PEX Connector	
	Internal:On-board PCB antenna	
Hardware Parameters	Data Interface	UART
		SPI, PWM, GPIO
	Operating Voltage	3.3~4.2V
	Operating Current	Peak [Continuous TX]: ~220mA Average. ~30mA, Peak: 220mA
	Operating Temp.	-25°C - 85°C
	Storage Temp.	-45°C - 125°C
Dimensions and Size	23.1mm×32.8mm×(3.45±0.3)mm	
Software Parameters	Network Type	STA, BT2.1
	Security Mechanisms	WEP/WPA-PSK/WPA2-PSK
	Encryption	WEP64/WEP128/TKIP/AES
	Update Firmware	Local Wireless, Remote
	Customization	Web Page Upgrade
		Support SDK for application develop
	Network Protocol	IPv4, TCP/UDP/HTTP
User Configuration	AT+instruction set. Android/ iOS Bluetooth Smart Link APP tools	

1.4. Key Application

- Handheld device
- Personal medical
- Industrial control
- Remote monitor
- IOT application
- Industrial sensor and controller
- Portable wireless communication product.
- Consumer electronics

1.5. Hardware Introduction

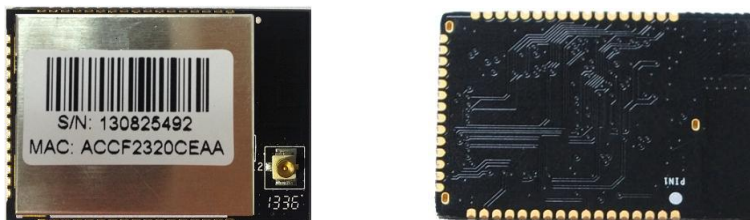

Figure 1. HF-LPC100 View

1.5.1. Pin Definition

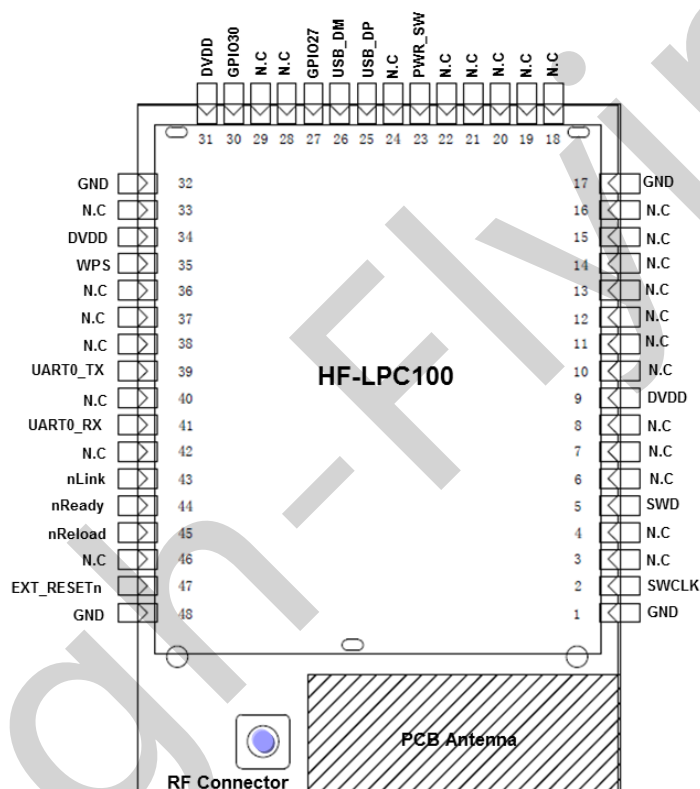

Figure 2. HF-LPC100 Pins map

Table 2 HF-LPC100 Pins Definition

Pin	Description	Net Name	Signal Type	Comments
1,17,32,48	Ground	GND	Power	
2	Debug Pin	SWCLK	I, PD	Debug functional pin, No connect if not use.
3		NC		
4		NC		
5	Debug Pin	SWD	I/O,PU	

Pin	Description	Net Name	Signal Type	Comments
6		N.C		No connect
7		N.C		No connect
8		N.C		No connect
9	+3.3V Power	DVDD	Power	
10		N.C		No connect
11		N.C		No connect
12		N.C		No connect
13		N.C		No connect
14		N.C		No connect
15		N.C		No connect
16		N.C		No connect
18		N.C		No connect
19		N.C		No connect
20		N.C		No connect
21		N.C		No connect
22		N.C		No connect
23	Power Control Switch	PWM_SW	I,PU	(Function is reserved)
24		N.C		No connect
25	USB1.1 D+	USB_DP	I/O	GPIO25, No connect if not use.
26	USB1.1 D-	USB_DM	I/O	GPIO26, No connect if not use.
27	GPIO	GPIO27	I/O	GPIO27, No connect if not use.
28		N.C		No connect
29		N.C		No connect
30	GPIO/AD	GPIO30	I/O	GPIO30, No connect if not use.
31	+3.3V Power	DVDD	Power	
33		N.C		No connect
34	+3.3 Power	DVDD	Power	
35	WPS Function	WPS	I/O	GPIO35, No connect if not use.
36		N.C		No connect
37		N.C		No connect
38		N.C		No connect
39	UART0	UART0_TX	O	GPIO39, No connect if not use.
40		N.C		No connect
41	UART0	UART0_RX	I	GPIO41, No connect if not use.
42		N.C		No connect
43	Wi-Fi Status	nLink	O	"0"- Wi-Fi is connected "1"-Wi-Fi is not connected
44	Module Boot Up Indicator	nReady	O	"0" – Boot-up OK; "1" – Boot-up No OK;

Pin	Description	Net Name	Signal Type	Comments
				GPIO44, No connect if not use.;
45	Multi-Function	nReload	I,PU	
46		N.C		No connect
47	Module Reset	EXT_RESETn	I,PU	“Low” effective reset input.

<Remark>:

I — input; O — output

PU—pull up; PD—pull down; I/O: digital I/O; Power—power supply

1.5.2. Electrical Characteristic

Table 3 Electrical Characteristic

Parameter	Condition	Min.	Typ.	Max.	Unit
Storage temperature range		-45		125	°C
Maximum soldering temperature	IPC/JEDEC J-STD-020			260	°C
Supply voltage		0		3.8	V
Voltage on any I/O pin		0		3.3	V
ESD (Human Body Model HBM)	TAMB=25°C			2	KV
ESD (Charged Device Model, CDM)	TAMB=25°C			1	KV

Table 4 Power Supply & Power Consumption

Parameter	Condition	Min.	Typ.	Max.	Unit
Operating Supply voltage		2.8	3.3	3.8	V
Supply current, peak	Continuous Tx		220		mA
Supply current, IEEE PS	DTIM=100ms		30		mA
Output high voltage	Sourcing 6mA	2.8			V
Output low voltage	Sinking 6mA			0.2	V
Input high voltage		2.2			V
Input low voltage				0.8	V
GPIO Input pull-up resistor			200		kΩ
GPIO Input pull-down resistor			200		kΩ

1.5.3. Mechanical Size

HF-LPC100 physical size (unit: mm) as below:

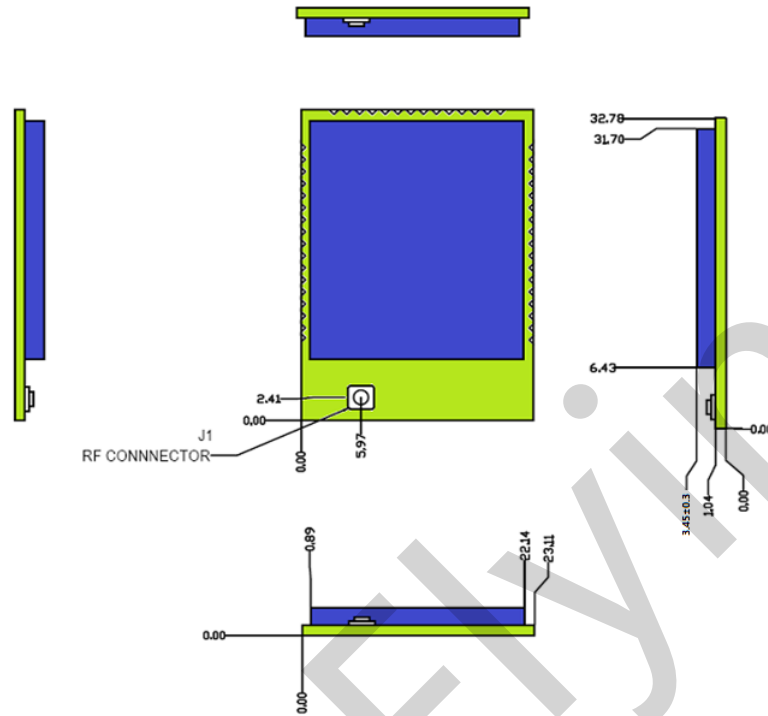

Figure 3. HF-LPC100 Mechanical Dimension

HF-LPC100 module PCB symbol size (unit :mm) as below:

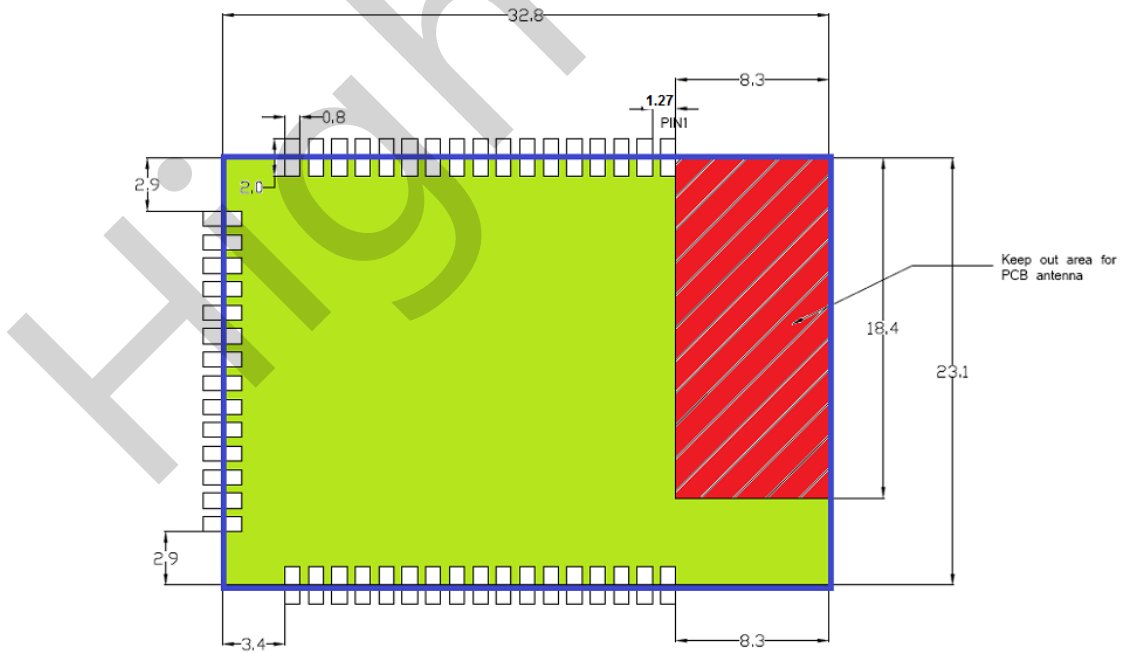

Figure 4. HF-LPC100 PCB symbol size

1.5.4. On-board Chip Antenna

HF-LPC100 module support internal on-board chip antenna option. When customer select internal antenna, you shall comply with following antenna design rules and module location suggestions:

- For customer PCB, RED color region (8.3x18.4mm) can't put component or paste GND net;
- Antenna must away from metal or high components at least 10mm;
- Antenna can't be shielded by any metal enclosure; All cover, include plastic, shall away from antenna at least 10mm

Meanwhile please contact High Flying technique support to assist regarding module placement and Layout design.

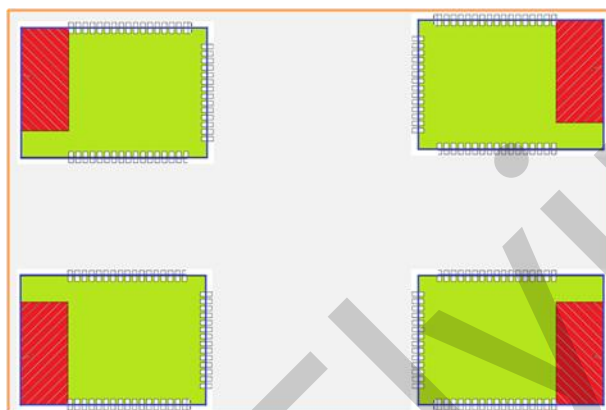

Figure 5. HF-LPC100 module placement region

1.5.5. External Antenna

HF-LPC100 module supports internal antenna and external antenna(I-PEX) option for user dedicated application.

If user select external antenna, HF-LPC100 modules must be connected to the 2.4G antenna according to IEEE 802.11b/g/n standards.

The antenna parameter required as table 5

Table 5 HF-LPC100 External Antenna Parameter

Item	Parameter
Frequency	2.4~2.5GHz
Impedance	50 Ohm
VSWR	2 (Max)
Return loss	-10dB (Max)
Connector type	I-PEX or populate directly

1.5.6. Evaluation Kit

High-Flying provides the evaluation kit to promote user to familiar the product and develop the detailed application. The evaluation kit shown as below, user can connect to HF-LPC100 module with the RS-232 UART, RS485, USB (Internal USB to UART convertor) or Wireless port to configure the parameters, manage the module or do the some functional tests. Evaluation kit support USB power supply and 5-18V DC input.

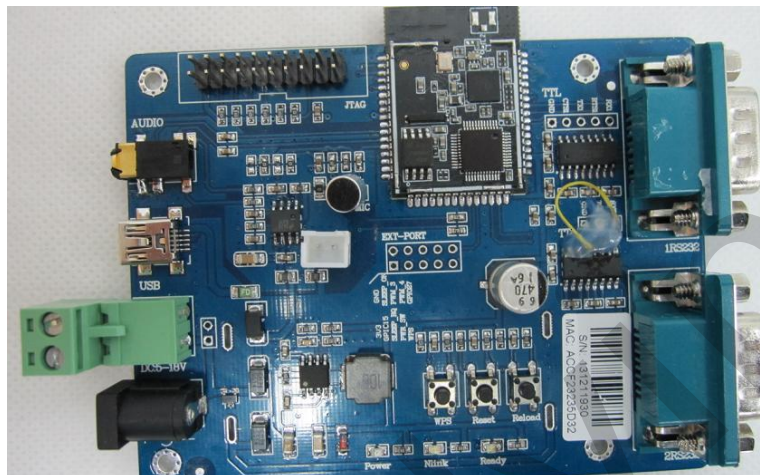

Figure 6. HF-LPC100 Evaluation Kit(TBD)

<Notes>: User need download USB to UART port driver from High-Flying web or contact with technical support people for more detail.

The external interface description for evaluation kit see Table 6:

Table 6 HF-LPC100 Evaluation kit interface description

Function	Name	description
External interface	COM1	data/command RS-232 interface 1
	JTAG	JTAG data debug interface (not available for customer)
	Microphone	MIC INPUT, used for Wi-Fi configuration or audio record
	Speaker	Audio output interface (for speaker)
	USB	USB1.1 data interface
	DC Jack	DC 5~18V Input
	EXT PORT	HF-LPC100 GPIO function extend interface connector
LED	Power	3.3V power indicator
	nLink	nLink -Wi-Fi status indicator:(on-connected; off-disconnect)

Function	Name	description
	nReady	nReady – module boot-up or upgrade ok on: module boot-up ok; off: module boot-up failed; twinkle: remote upgrading, twinkle frequency and download speed is in direct proportion
Button	nReset	Reset button
	nReload	Press the button over 3 seconds to restore factory setting

1.5.7. Order Information

Based on customer requirement, HF-LPC100 can support difference variants and physical type ,detail as below:

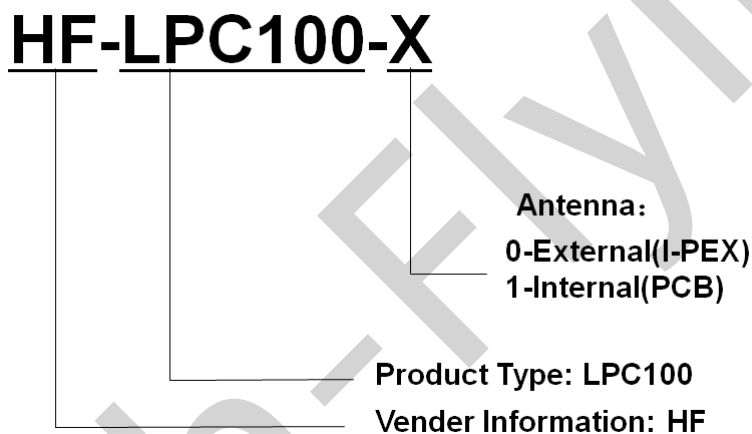

Figure 7. HF-LPC100 order information

1.6. Typical Application

1.6.1. Hardware Typical Application

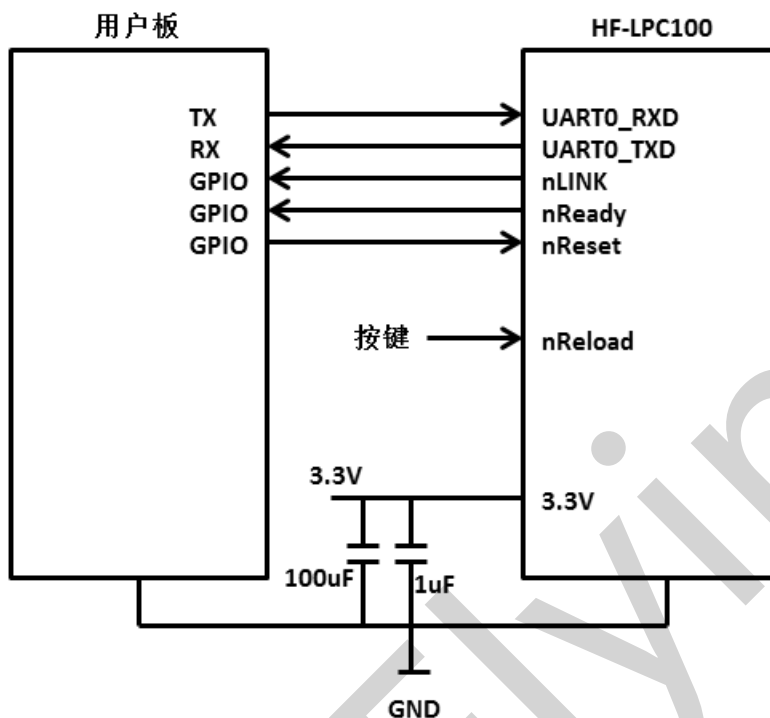

Figure 8. HF-LPC100 hardware typical application

<Notes>

nReset- module reset signal. Input, low level effective.

There is pull-up resistor internal and no external pull-up required. When module power up or some issue happened, MCU need assert nRST signal "0" at least 10ms, then set "1" to keep module fully reset.

nLink- Module WIFI connection status indication. Output.

(This pin is recommend to connect to LED, indicate status when the module in wireless upgrade mode)

When module connects to AP (AP associated), this pin will output "0". This signal used to judge if module already at WiFi connection status. There is pull-up resistor internal and no external pull-up required. If nLink function not required, can leave this pin open.

nReady- Module boot up ready signal. Output. Logics "0" effective.

The module will output "0" after normal boot up. This signal used to judge if module finish boot up and ready for application or working at normal mode. If nReady function not required, can leave this pin open.

nReload- Module restore to factory default configuration. Input. Logics "0" effective.

(This pin is recommend to connect to button, is used to enter wireless upgrade mode)

User can de-assert nReload signal “0” more than 3s through button or MCU pin, then release, module will restore to factory default configuration and re-start boot up process.. If nReload function not required, can leave this pin open.

UART0_TXD/RXD-UART port data transmit and receive signal.

1.7. Bluetooth Sonic Configuration

Sonic configuration is a Wi-Fi smart link method based on audio technology.(High Flying patent). By its natural advantage of audio transmit, Bluetooth enable module receive audio information sent from smart terminal. The APP on smart terminal compile the router’s password and ID to audio signal and play it through Bluetooth. Then the Wi-Fi module with Bluetooth will analysis the audio signal and realize the Wi-Fi connection.

Nowadays Bluetooth is the standard deployment on smart terminal. Since the good support to audio, this configuration has the minimum demand on smart terminals and greatly reduced the configure steps and instabilities, no matter it is Bluetooth 2.1, 3.0 or 4.0, or kinds of Android terminal, Iphone, Ipad . Any end users without technique background can quickly and easily realize the Wi-Fi connection to any routers with 100% success ratio.

2. FUNCTION DESCRIPTION

2.1. Wireless Networking

The wireless networking based on STA, user devices connect to router via LPC100.

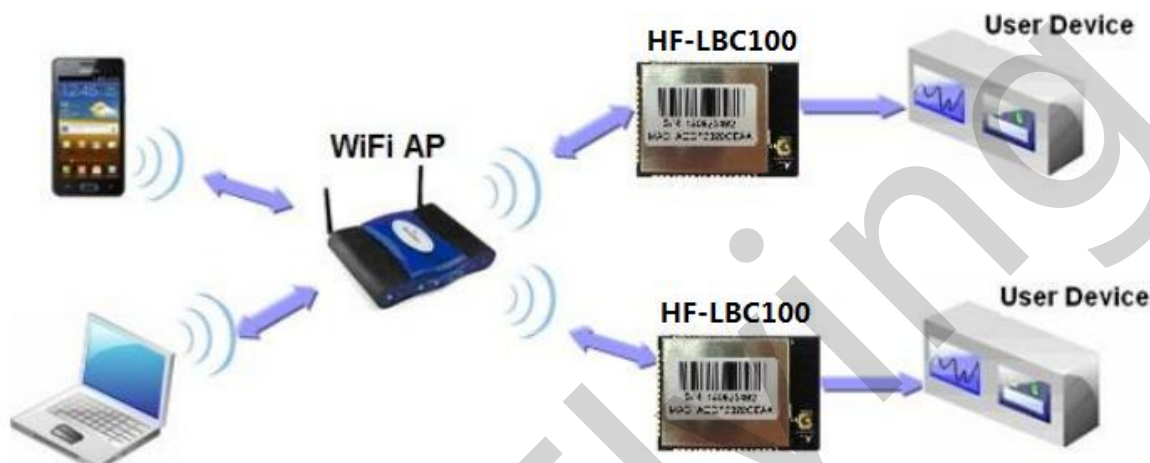

Figure 9. Basic HF-LPC100 wireless networking structure

2.2. Work mode: Transparent Transmission Mode

HF-LPC100 module support serial interface transparent transmission mode. The benefit of this mode is achieves a plug and play serial data port, and reduces user complexity furthest. In this mode, user should only configure the necessary parameters. After power on, module can automatically connect to the default wireless network and server.

As in this mode, the module's serial port always work in the transparent transmission mode, so users only need to think of it as a virtual serial cable, and send and receive data as using a simple serial. In other words, the serial cable of users' original serial devices is directly replaced with the module; user devices can be easy for wireless data transmission without any changes.

The transparent transmission mode can fully compatible with user's original software platform and reduce the software development effort for integrate wireless data transmission.

The parameter which needs to configure include:

- Wireless network parameter
 - ◆ Wireless network name (SSID)
 - ◆ Security mode
 - ◆ Encryption key
- Default TCP/UDP link parameter
 - ◆ Protocol type
 - ◆ Link type (server or Client)

- ◆ Target port ID number
- ◆ Target port IP address
- Serial port parameter
 - ◆ Baud rate
 - ◆ Data bit
 - ◆ Parity (check) bit
 - ◆ Stop bit
 - ◆ Hardware flow control

2.3. UART Frame Scheme

2.3.1. UART Free-frame

Module will check the intervals between any two bytes when receiving UART data. If this interval time exceeds defined value (50ms default), module will think it as the end of one frame and transfer this free-frame to Wi-Fi port, or HF-LPC100 will receive UART data until 1000 bytes, then transfer 1000 bytes frame to Wi-Fi port.

Default interval time is 50ms, once the interval over 50ms, it is the end of one frame.

In addition, the interval can be set as 10ms via AT command to meet customer's requirement on UART efficiency. According to our test, if set at 10ms, the circle WIFI → UART → WIFI delay will be around 40-50 ms if data is small.

If the interval is 10ms, and customers MCU can not send next byte within 10ms, then the UART data may be divided as fragment.

Through AT command AT+UARTTE=fast/normal to set interval time, fast means 10ms, normal means 50ms.

2.3.2. UART Auto-Frame

For data frame on UART, Module can be more effective by open UART auto-frame function. HF-LPC100 support UART auto-frame function. If user select open this function and setting auto-frame trigger length and auto-frame trigger time parameters, then module will auto framing the data which received from UART port and transmitting to the network as pre-defined data structure.

- **Auto-frame trigger length:** The fixed data length that module used to transmitting to the network.
- **Auto-frame trigger time:** After the trigger time, if UART port received data can't reach auto-frame trigger length, then module will transmitting available data to the network and bypass the auto-frame trigger length condition.

Detailed UART auto-frame function can refer to AT+ instruction set "UARTF/UARTFT/UARTFL" introduction.

2.4. Bluetooth Function

User can easily and quickly configure the module connect to AP Via LPC100 Bluetooth function. Detail steps as follow:

- ◆ User configure the module enter into Bluetooth quick link mode via smart link button or AT command.
- ◆ Use smart terminal search the Bluetooth on module and connect, system will indicate it's a audio device.
- ◆ Run the app on smart terminal, input SSID, password and confirm
- ◆ Module automatically receive the data and decode and obtain the total configure dat. The whole process is less than 3 second, and success rate is nearly 100%
- ◆ Module automatically switch to Wi-Fi mode and connect to appointed AP
Please check Appendix D for details

2.5. Firmware Upgrade

HF-LPC100 support below online upgrade methods:

Compared to traditional UART upgrade, HF-LPC100 support more flexible and convenient method to realize the update of firmware and application.

HF-LPC100 module also support upgrade from remote HTTP server, keep module connects to AP router before execute remote HTTP upgrade. Remote upgrade have two methods: **Direct Download and Upgrade, Configure File Based Upgrade.**

◆ Configure file based upgrade

AT+UPURL command to set the remote directory which the configuration file located.

For example: AT+UPURL=http://www.hi-flying.com/admin/down/

Notes: The last '/' can't be remove

AT+UPFILE command to set the configuration file name, such as AT+UPFILE=config.txt

AT+UPST command to start remote Application upgrade. After execute this command, the module will firstly download configuration file ("config.txt"), then download the upgrade file base on the URL address listed in the configure file.

General "config.txt" file format as following example:

[URL]=http://10.10.100.100:80/lpb.bin

[URL]= the URL address of Application.

◆ Direct Download and Upgrade

AT+UPURL command to set the remote directory and file name, such as:

AT+UPURL=http://www.hi-flying.com/admin/down/lpb.bin

After execute this command, the module will directly download the "lpb.bin" file from remote directory and start upgrade Application.

Notes: please contact with high-flying technical people before upgrade firmware, or maybe damage the module and can't work again.

High-Flying

2.6. GPIO/PWM Function(TBD)

HF-LPC100 support utmost eight PWM/GPIO pins (refer to 1.2.1 pin definition), to realize the application based on GPIO/PWM. User can switch to PWM mode read and write GPIO/PWM pins status when needed.

Table 8 HF-LPC100 GPIO/PWM Pin mapping table

GPIO	Configured function	description	default setting	type
GPIO13	GPIO channel	GPIO13	GPIO13	I/O
GPIO25	GPIO/USB channel	USB_DP	USB_DP	I/O
GPIO26	GPIO/USB channel	USB_DM	USB_DM	I/O
GPIO27	GPIO channel	GPIO27	GPIO27	I/O
GPIO30	GPIO/AD channel	GPIO30	GPIO30	I/O
GPIO35	GPIO/WPS channel	WPS	GPIO35	I/O
GPIO43	GPIO/nLink	nLink	nLink	I/O
GPIO44	GPIO/nReady	nReady	nReady	O

module works at PWM mode, PC and other devices can setup connection (TCP/UDP) through WiFi, then read/write GPIO/PWM information through command data.. Command as follows:

- GPIO n OUT 0, Set GPIO n as output and output '0', Response GPIO OK or GPIO NOK;
- GPIO n OUT 1, Set GPIO n as output and output '1', Response GPIO OK or GPIO NOK;
- GPIO n GET, Read GPIO n pin status, Response +ok=1 or GPIO NOK
- GPIO n SET, Save GPIO n set, Response GPIO OK or GPIO NOK
- PWM n frequency duty, Set PWM n Channel output, Response GPIO OK or GPIO NOK
- PWM n GET, Read PWM n Channel set, Response +ok=frequency duty or PWM NOK
- PWM n SET, Save PWM n Channel set, Response PWM OK or PWM NOK

Notes: Please refer to Appendix B for details.

2.7. Double SOCKET Communication Function

HF-LPC100 WI-FI module support double socket communication, the Socket B function is disabled by default.

After the module boot-up, send command "AT+SOCKB" to set the connection parameter, send command "AT+TCPDISB=on" to try to connect with TCP server, the module will stop connecting after three failures. Send command "AT+TCPDISB=on" to make connection. Send command "AT+TCPDISB=off" to close connection. Send command "AT+TCPLKB" to inquire TCP connection.

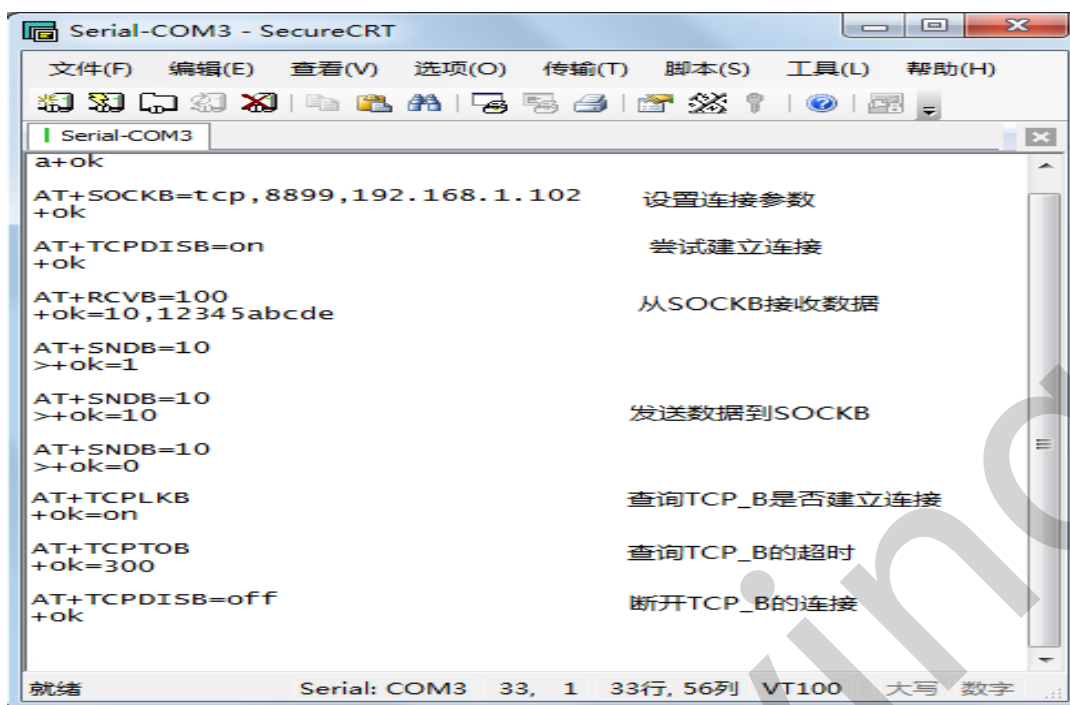

Figure 10. Double Socket setting view

3. AT INSTRUCTION INTRODUCTION

3.1. Configuration Mode

When HF-LPC100 power up, it will default works as transparent transmission mode, then user can switch to configuration mode by serial port command. The UART default parameters setting as below figure:

Parameters	Default Setting
SSID	HF-LPC100
IP Address	10.10.100.254
Subnet Mask	255.255.255.0
User Name	admin
Password	admin

Figure 11. HF-LPC100 Default UART parameter

In configuration mode, user can configure module by AT+ Instruction via UART port .

<Notes>: for AT command debug tool ,we recommend use SecureCRT or High Flying APP. User can download from our website, all below introduction applied our tools.

3.1.1. Switch to Configuration Mode

Two steps to finish switching from transparent transmission mode to configuration mode.

- **UART input “+++”, after module receive “+++”, and feedback “a” as confirmation.**
- **UART input “a”, after module receive “a” and feedback “+ok” to go into AT+ instruction set configuration mode.**

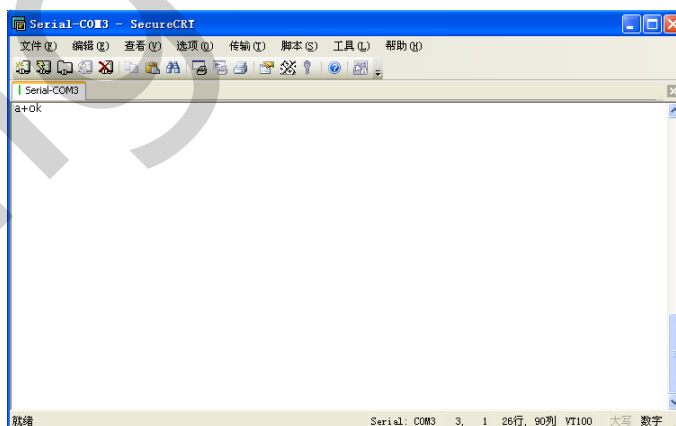
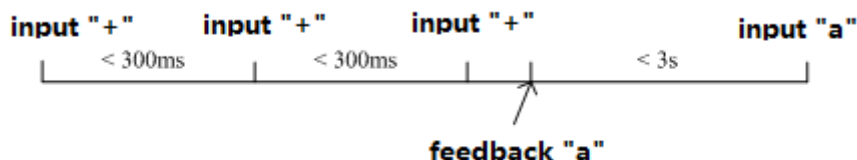

Figure 12. Switch to configuration mode

<Notes>:

When user input “+++” (No “Enter” key required), the UART port will display feedback information “a”, and not display input information“+++” as above UART display.

“+++” and “a” should be input in a certain period of time to make the module switch to configuration mode. Like the following sequence.



In configuration mode, user can set ,check, reset module or back to transparent transmission mode by AT+ Instruction via UART port . Details instruction refer to next chapter.

3.2. AT+ Instruction Set Overview

User can input AT+ Instruction through hyper terminal or other serial debug terminal , also can program the AT+ Instruction to script. User can also input “AT+H” to list all AT+ Instruction and description to start.

```

AT+: NONE command, reply "+ok".
AT+ASWD: Set/Query WiFi configuration code.
AT+E: Echo ON/Off, to turn on/off command line echo function.
AT+ENTM: goto Through Mode.
AT+NETP: Set/Get the Net Protocol Parameters.
AT+MSLP: Set/Query deep sleep mode parameters.
AT+PING: General PING command.
AT+PING: General PING command.
AT+WMODE: Set/Get the WIFI Operation Mode (AP or STA).
AT+WSLK: Get Link Status of the Module (Only for STA Mode).
AT+WSLQ: Get Link Quality of the Module (Only for STA Mode).
AT+WSCAN: Get The AP site Survey (only for STA Mode).
AT+TCPLK: Get The state of TCP link.
AT+TCPTO: Set/Get TCP time out.
AT+TCPDIS: Connect/Dis-connect the TCP Client link
AT+RCV: Recv data from WIFI
AT+SEND: Send data to WIFI
AT+WSDNS: Set/Get the DNS Server address.
AT+UPURL: Set/Get the path of remote upgrade.
AT+UPFILE: Set/Get the file name of config file for remote upgrade.
AT+UPST: Start the remote upgrade.
AT+UPCFG: Start the remote upgrade default setting.
AT+UPAUTO: Start the remote upgrade by config file.
AT+LOGSW: Enable/Disable upload logs.
AT+LOGPORT: set/get the UDP port for upload logs.
AT+SOCKB: Set/Get Parameters of socket_b.
AT+TCPLKB: Get The state of TCP_B link.
AT+TCPTOB: Set/Get TCP_B time out.
AT+TCPDISB: Connect/Dis-connect the TCP_B Client link.
AT+RCVB: Recv data from socket_b
AT+SNDB: Send data to socket_b
AT+RELD: Reload the default setting and reboot.
AT+SLPEN: Put on/off the GPIO7.
AT+RLDEN: Put on/off the GPIO45.
AT+Z: Reset the Module.
AT+MID: Get The Module ID.
AT+VER: Get application version.
AT+WANN: Set/Get The WAN setting if in STA mode.
AT+LANN: Set/Get The LAN setting if in ADHOC mode.
AT+UART: Set/Get the UART0/UART1 Parameters.
AT+WSSSID: Set/get the AP's SSID of WIFI STA Mode.
AT+NDBG: set/get debug level
AT+WPSBTNEN: enable/disable wps button
AT+MDCH: Put on/off automatic switching WIFI mode.
AT+SMTLKVER: Choose smartlink version.
AT+H: show help
    
```

Figure 13. "AT+H" instruction for help

3.2.1. Instruction Syntax format

AT+ Instruction protocol is based on the instruction of ASCII command style, the description of syntax format as follow.

➤ **Format Description**

- <>: Means the parts must be included
- []: Means the optional part

➤ **Command Message**

AT+<CMD>[op][para-1,para-2,para-3,para-4...]<CR>

- AT+: Prefix of command message;
- CMD: Command string;
- [op]: Symbol of command operator,
 - ◆ “=” : The command requires parameters input;
 - ◆ “NULL”: Query the current command parameters setting;
- [para-n]: Parameters input for setting if required;
- <CR>: “Enter” Key, it’s 0x0a or 0x0d in ASCII;

Notes: When input AT+ Instruction, “AT+<CMD>” character will display capital letter automatic and other parts will not change as you input.

➤ **Response Message**

+<RSP>[op] [para-1,para-2,para-3,para-4...]<CR><LF><CR><LF>

- +: Prefix of response message;
- RSP: Response string;
 - ◆ “ok” : Success
 - ◆ “ERR”: Failure
- [op] : =
- [para-n]: Parameters if query command or Error code when error happened;
- <CR>: ASCII 0x0d;
- <LF>: ASCII 0x0a;

➤ **Error Code**

Table 10 Error Code Description

Error code	Description
-1	Invalid Command Format
-2	Invalid command
-3	Invalid Operation Symbol
-4	Invalid Parameter
-5	Operation Not Permitted

3.2.2. At+ Instruction set

Table 11 AT+ Instruction Set List

instruction	Description
<null>	Null
Management Instruction Set	
E	Open/Close show back function

instruction	Description
WMODE	Set/Query Wi-Fi work mode (AP/STA/APSTA)
ENTM	Set module into transparent transition mode
TMODE	Set/Query module data transfer mode
MID	Query module ID information
VER	Query module software version information
LVER	Query module detailed software version
FWSZ	Query Wi-Fi driver size
RELD	Restore to factory default setting
FCLR	Erase factory setting
Z	Re-start module
H	help
Configure parameter instruction set	
CFGRD	Bulk read user configure parameter
CFGWR	Bulk write user configure parameter
CFGFR	Bulk read factory configure parameter
CFGTF	Copy User Parameters to Factory Default Parameters
UART instruction set	
UART	Set/Query serial port parameters
UARTF	Open/Close UART auto-frame function
UARTFT	Set/Query UART auto-frame trigger time
UARTFL	Set/Query UART auto-frame trigger length
UARTTE	Set/Query UART free-frame trigger time between two bytes
Command Mode Set	
SEND	Send Data at Command Mode
RECV	Receive Data at Command Mode
Network Instruction Set	
PING	Network "Ping" Instruction
NETP	Set/Query network protocol parameters
MAXSK	Set/Query TCP Client connection number
TCPLK	Query if TCP link already build-up
TCPTO	Set/Query TCP timeout
TCPDIS	Open/Close TCP link
SOCKB	Set/Query SOCKB parameters
TCPDISB	Open/Close SOCKB TCP link
TCPTOB	Set/Query SOCKB TCP timeout
TCPLKB	Query if SOCKB TCP link already build-up
SNDB	Send data to SOCKB in Command Mode
RCVB	Receive data from SOCKB in Command Mode
MAXSK	Set/Query TCP Client connection number
Wi-Fi STA instruction set	

instruction	Description
WSKEY	Set/Query STA security parameters
WSSID	Set/Query associated AP SSID parameters
WANN	Set/Query STA's network parameters
WSMAC	Set/Query STA's MAC address
BTMAC	Set/Query Bluetooth Mac address parameter
WSKEY	Set/Query STA security parameters
WSSID	Set/Query associated AP SSID parameters
WANN	Set/Query STA's network parameters
WSMAC	Set/Query STA's MAC address
Remote Upgrade Instruction Set	
UPURL	Set/Query remote upgrade URL address
UPFILE	Set/Query remote upgrade configure file name
LOGSW	Open/Close remote upgrade log
LOGPORT	Set/Query UDP port of remote upgrade log
UPST	Start remote Application upgrade
Power Management Instruction Set	
MSLP	Set module to low power mode
Network Time Set	
NTPRF	Set/Query time calibration interval
NTPEN	Enable/Disable time calibration function
NTPTM	Query time
NTPSER	Set/Query NTP server IP
Others Instruction Set	
WRMID	Set module ID
RLDEN	Set/Query GPIO45 status
ASWD	Set/Query Wi-Fi configuration code
MDCH	Set Wi-Fi Auto Switch Function
TXPWR	Set/Query Wi-Fi Transmit Power
SMTLK	Start Smart Link function
WPSBTNEN	Set/Query WPS button function
LPTIO	nRead/ nLink/ WPS function mapping

<Notes>: wireless configure do not support CFGRD yet

3.2.2.1. AT+E

- Function: Open/Close show back function;
- Format
 - Set option

AT+E=<status><CR>

+ok<CR><LF><CR><LF>

- Parameter :
 - ◆ status: echo status

- ◇ on: open echo
- ◇ off: close echo

When module firstly switch from transparent transmission to configuration mode, show back status is open, input “AT+E” to close show back function, input “AT+E” again to open show back function.

。

3.2.2.2. AT+ENTM

- Function: Set module into transparent transmission mode;
- Format

AT+ENTM<CR>

+ok<CR><LF><CR><LF>

When operate this command, module switch from configuration mode to transparent transmission mode.

3.2.2.3. AT+TMODE

- Function: Set/Query module data transfer mode. Setting is valid after reset.
- Format

- ◆ Query:

AT+TMODE<CR>

+ok=<tmode><CR><LF><CR><LF>

- ◆ set option

AT+TMODE=<tmode><CR>

+ok<CR><LF><CR><LF>

- parameter:
 - ◆ tmode: data transfer mode, includes
 - ◇ throughput: throughput mode
 - ◇ cmd: command mode
 - ◇ pwm: PWM/GPIO mode

3.2.2.4. AT+MID

- function: query module ID information
- format :

AT+MID<CR>

+ok=<module_id><CR><LF><CR><LF>

- parameter:
 - ◆ module_id: module ID
 - ◇ HF-LPC100。

Notes: User can set this parameter through AT+WRMID.

3.2.2.5. AT+VER

- Function: query module software version information
- Format

AT+VER<CR>

+ok=<ver><CR><LF><CR><LF>

- Parameter :
 - ◆ ver: module software version information

3.2.2.6. AT+LVER

- Function: Query module detailed software version information
- Format :

AT+LVER<CR>

+ok=<ver><CR><LF><CR><LF>

- Parameter
 - ◆ ver: module software details version information

3.2.2.7. AT+RELD

- Function: module restore to factory default setting
- Format

AT+RELD<CR>

+ok=rebooting...<CR><LF><CR><LF>

When operate this command, module will restore to factory default setting and reboot.

3.2.2.8. AT+FCLR

- Function: erase factory setting
- Format
 - ◆ Query operation

AT+FCLR<CR>

+ok<CR><LF><CR><LF>

3.2.2.9. AT+Z

- Function: re-start module
- Format

AT+Z<CR>

3.2.2.10. AT+H

- Function: Help
- Format

AT+H<CR>

+ok=<command help><CR><LF><CR><LF>

- Parameter
 - ◆ command help : command introduction

3.2.2.11. AT+CFGRD

- Function: bulk read user configure parameter
- Format
 - ◆ Query operation

AT+CFGRD<CR>

+ok=<config><CR><LF><CR><LF>

- Parameter
 - ◆ config: the first two bytes means the length of read configure parameter.

3.2.2.12. AT+CFGWR

- Function : bulk write user configure parameter
- Format
 - ◆ Set operation

AT+CFGWR=<config><CR>

+ok<CR><LF><CR><LF>

- Parameter
 - ◆ config: the first two bytes means the length of written configure parameter.

3.2.2.13. AT+CFGFR

- Function: bulk read factory configure parameter
- Format
 - ◆ Query operation

AT+CFGFR<CR>

+ok=<config><CR><LF><CR><LF>

- Parameter
 - ◆ config: the first two bytes means the length of read configure parameter.

3.2.2.14. AT+CFGTF

- Function: copy user configure parameter to factory default configure parameter
- Format
 - ◆ Query

AT+CFGTF<CR>

+ok=<status><CR><LF><CR><LF>

- Parameter
 - ◆ status: feedback operation status

3.2.2.15. AT+UART

- Function: set/query serial parameter, setting is valid after reset
- Format
 - ◆ Query operation

AT+UART<CR>

+ok=<baudrate,data_bits,stop_bit,parity,flowctrl><CR><LF><CR><LF>

- ◆ Set operation

AT+UART=<baudrate,data_bits,stop_bit,parity,flowctrl><CR>

+ok<CR><LF><CR><LF>

- Parameter
 - ◆ baudrate
 - ◇ 300,600,1200,1800,2400,4800,9600,19200,38400,57600,115200,230400,380400,460800,921600

- ◆ data_bits:
 - ◇ 8
- ◆ stop_bits:
 - ◇ 1,2
- ◆ parity:
 - ◇ NONE
 - ◇ EVEN
 - ◇ ODD
- ◆ flowctrl: (CTSRTS)
 - ◇ NFC: no hard ware flow control
 - ◇ FC: hard ware flow control

3.2.2.16. AT+UARTF

- Function :open/close UART auto-frame function
- Format
 - ◆ Query operation

```
AT+UARTF<CR>
```

```
+ok=<para><CR><LF><CR><LF>
```
 - ◆ Set operation

```
AT+UARTF=<para ><CR>
```

```
+ok<CR><LF><CR><LF>
```
- Parameter
 - ◆ para:
 - ◇ disable - close auto-frame function
 - ◇ enable - open auto-frame function

3.2.2.17. AT+UARTFT

- Function :set/query UART auto-frame trigger time
- Format
 - ◆ Query operation

```
AT+UARTFT<CR>
```

```
+ok=<time><CR><LF><CR><LF>
```
 - ◆ Set operation

```
AT+UARTFT=<time><CR>
```

```
+ok<CR><LF><CR><LF>
```
- Parameter
 - ◆ time: auto-frame trigger time, unit: ms, range 100~10000.

3.2.2.18. AT+UARTFL

- Function :set/query UART auto-frame trigger time
- Format
 - ◆ Query operation

```
AT+UARTFL<CR>
```

```
+ok=<len><CR><LF><CR><LF>
```

- ◆ Set operation

AT+UARTFL=<len ><CR>

+ok<CR><LF><CR><LF>

- Parameter

- ◆ len: Range 8 ~1000; Unit: Byte. Auto-frame trigger length;

3.2.2.19. AT+UARTTE

- Function: Set/Query UART free-frame trigger time between two bytes;
- format

- ◆ query operation

AT+UARTTE<CR>

+ok=<mode><CR><LF><CR><LF>

- ◆ set operation

AT+UARTTE=<mode ><CR>

+ok<CR><LF><CR><LF>

- Parameter

- ◆ mode:

- fast: No free-frame trigger time, the UART data may be break into two fragment
- normal: free-frame trigger time between two bytes is 50ms;

3.2.2.20. AT+SEND

- Function: send data to SOCKA at command mode
- Format

AT+SEND=<data_lenth><CR>

+ok<CR><LF><CR><LF>

- Parameter

- ◆ data_lenth: Length of send data. Range: 0~1000 Byte

The UART port will wait 3 seconds for input after this command is succeed and feedback “>” The data received from UART port is sent to SOCKA. If the interval of two bytes is more than 10ms, the data will be sent instantly.

3.2.2.21. AT+RECV

- Function: receive data from SOCKA at command mode
- Format

AT+RECV=<data_lenth><CR>

+ok=< data_lenth, data_content><CR><LF><CR><LF>

- Parameter

- ◆ data_lenth: the length of received data, range 0~1000 byte
- ◆ data_content: the content of received data

If not receive any data in 3 second, then feedback +ok=0.

3.2.2.22. AT+PING

- Function : network “PING” instruction
- Format

- ◆ Setting

AT+PING=<IP_address><CR>

+ok=<sta><CR><LF><CR><LF>

- Parameter

- ◆ sta: feedback result

- ✧ Success
- ✧ Timeout
- ✧ Unknown host

3.2.2.23. AT+NETP

- Function :set/query network protocol parameter. The change of TCP port and address of TCP clients valid immediately, the other changes is valid after reset

- Format

- ◆ Query operation

AT+NETP<CR>

+ok=<protocol,CS,port,IP><CR><LF><CR><LF>

- ◆ Set operation

AT+NETP=<protocol,CS,port,IP><CR>

+ok<CR><LF><CR><LF>

- Parameter

- ◆ Protocol: protocol type, include:

- ✧ TCP
- ✧ UDP

- ◆ CS: network mode

- ✧ SERVER
- ✧ CLIENT

- ◆ Port: protocol port ID, decimal digit and less than 65535

- ◆ IP: server's IP address or domain name when module set as "client"

If set as UDP SERVER, the module will save the IP address and port of the latest UDP packet received and send data to the saved IP address and port. When module under initialization status, it will send data to this IP address and port set by the command.

If set as UDP CLIENTS , module has no memory function

3.2.2.24. AT+MAXSK

- Function: set/query TCP Client connection number when work as TCP server

- Format

- ◆ Query operation

AT+MAXSK<CR>

+ok=<num><CR><LF><CR><LF>

- ◆ Set operation

AT+MAXSK=<num><CR>

+ok<CR><LF><CR><LF>

- Parameter

- ◆ num: limit TCP Client connection number, default is 5, range: 1~5。

Any data received by each socket will send to serial directly, the data received from serial will send out by each socket in sequence.

3.2.2.25. AT+TCPLK

- Function : query if TCP link already build-up

- Format

AT+TCPLK<CR>

+ok=<sta><CR><LF><CR><LF>

- Parameter

- ◆ sta.: if module already setup TCP link
 - ◇ on: TCP link setup
 - ◇ off: TCP link not setup

3.2.2.26. AT+TCPTO

- Function: set/query TCP timeout, setting is valid after reset

- Format

- ◆ Query operation

AT+TCPTO<CR>

+ok=<time><CR><LF><CR><LF>

- ◆ Set operation

AT+TCPTO=<time ><CR>

+ok<CR><LF><CR><LF>

- Parameter

- ◆ Time: TCP timeout time
 - ◇ <= 600: 600s
 - ◇ >=0: 0 means no timeout setting
 - ◇ Default: 300s

Module begin to count time when TCP channel don't receive any data, clear time counter when TCP channel receive any data. If the time counter reaches the TCPTO, the TCP channel will be break. If the module work in TCP Client, it will connect the TCP server instantly and when the module work in TCP Server, the TCP client device should make the connection itself.

3.2.2.27. AT+TCPDIS

- Function: open/close TCP link

- Format

- ◆ Query operation

AT+TCPDIS<CR>

+ok=<sta><CR><LF><CR><LF>

- ◆ Set operation

AT+TCPDIS =<on/off><CR>

+ok<CR><LF><CR><LF>

- Parameter

When query, sta.: Feedback if TCP Client can be link,

- ◇ On, TCP link close
- ◇ off, TCP link on

When setting, “off” means close TCP link. After finish this command, module disconnect TCP link and not connect again. “On” means open TCP link. After finish this command, module re-connect TCP server right away. If user didn't save the command, after reset, module will open TCP by default.

3.2.2.28. AT+SOCKB

- function: set/query SOCKB parameter, setting is valid after reset:
- Format

- ◆ Query operation

AT+SOCKB<CR>

+ok=<protocol,port,IP><CR><LF><CR><LF>

- ◆ Set operation

AT+SOCKB=<protocol,port,IP><CR>

+ok<CR><LF><CR><LF>

- Parameter

- ◆ Protocol: protocol type ,includes
 - ◇ TCP, only means TCP Client
 - ◇ UDP, UDP client
 - ◇ UDPS, UDP server
- ◆ Port: protocol port, decimal digital, less than 65535
- ◆ IP: target IP address, support domain name

If set as UDP SERVER, the module will save the IP address and port of the latest UDP packet received and send data to the saved IP address and port. When module under initialization status, it will send data to this IP address and port set by the command.

3.2.2.29. AT+TCPDISB

- Function: open/close SOCKB connection
- Format

- ◆ Query operation

AT+TCPDISB<CR>

+ok=<sta><CR><LF><CR><LF>

- ◆ Set operation

AT+TCPDISB =<on/off><CR>

+ok<CR><LF><CR><LF>

- Parameter

When setting, “off” means close TCP link. After finish this command, module disconnect TCP link and not connect again. “On” means open TCP link. After finish this command, module re-connect TCP server right away. If user didn't save the command, after reset, module will open SOCKB by default.

3.2.2.30. AT+TCPTOB

- Function: set/query SOCKB timeout, setting is valid after reset

- Format

- ◆ Query operation

AT+TCPTOB<CR>

+ok=<time><CR><LF><CR><LF>

- ◆ Set operation

AT+TCPTOB=<time ><CR>

+ok<CR><LF><CR><LF>

- Parameter:

- ◆ Time: TCP timeout time

- ◇ ≤ 600: 600s

- ◇ ≥ 0: 0 means no timeout setting

- ◇ Default: 300s

When timeout module will close SOCKB connection automatically, and will not reconnect ; need to send TCPDISB command to reconnect.

3.2.2.31. AT+TCPLKB

- Function :set/query SOCKB connection status

- Format

AT+TCPLKB<CR>

+ok=<sta><CR><LF><CR><LF>

- Parameter

- ◆ sta.: SOCKB connection status

- ◇ on: TCP connected

- ◇ off: TCP disconnect

3.2.2.32. AT+UDPLCPT

- Function: set/query local port of Socket A, Socket B when work as UDP communication

- Format :

- ◆ Query operation

AT+UDPLCPT<CR>

+ok=<porta,portb><CR><LF><CR><LF>

- ◆ Set operation

AT+UDPLCPT=<porta,portb><CR>

+ok<CR><LF><CR><LF>

- Parameter

- ◆ porta: the local port when Socket A work as UDP protocol, 0 means not fixed

- ◆ portb: the local port when Socket B work as UDP protocol, 0 means not fixed

3.2.2.33. AT+SNDB

- Function send data to SOCKB at command mode

- Format

AT+SNDB=<data_lenth ><CR>

+ok<CR><LF><CR><LF>

- Parameter

- ◆ data_lenth: the length of send data, range :1~1000 byte

The UART port will wait 3 seconds for input after this command is succeed and feedback ">". The data received from UART port is sent to SOCKB. If the interval of two bytes is more than 10ms, the data will be sent instantly.

3.2.2.34. AT+RCVB

- Function: receive data from SOCKB at command mode

- Format

AT+RCVB=<data_lenth><CR>

+ok=< data_lenth, data_content><CR><LF><CR><LF>

- Parameter

- ◆ data_lenth: length of received data, range :0~1000 byte
- ◆ data_content: content of received data

If no data received in 3s, feedback +ok=0

3.2.2.35. AT+WSSSID

- Function :set/query associated AP SSID parameter, setting is valid after reset

- Format

- ◆ Query operation

AT+WSSSID<CR>

+ok=<ap's ssid><CR><LF><CR><LF>

- ◆ Set operation

AT+WSSSID=<ap's ssid ><CR>

+ok<CR><LF><CR><LF>

- Parameter

- ◆ ap's ssid: AP's SSID (support utmost 32 character)

3.2.2.36. AT+WSKEY

- Function :set/query STA security parameter. Setting is valid after reset

- Format

- ◆ Query operation

AT+WSKEY<CR>

+ok=<auth,encry,key><CR><LF><CR><LF>

- ◆ Set operation

AT+WSKEY=< auth,encry,key><CR>

+ok<CR><LF><CR><LF>

- Parameter

- ◆ auth: authentication mode ,includes
 - ◇ OPEN
 - ◇ SHARED
 - ◇ WPAPSK

- ◇ WPA2PSK
- ◆ encry: encryption algorithm
 - ◇ NONE: "auth=OPEN" effective
 - ◇ WEP-H:"auth=OPEN" or "SHARED" effective , HEX type
 - ◇ WEP-A:"auth=OPEN" or "SHARED" effective , ASCII type
 - ◇ TKIP: "auth= WPAPSK or WPA2PSK" effective
 - ◇ AES: "auth= WPAPSK or WPA2PSK" effective
- ◆ key: password , ASCII code less than 64 bit and bigger 8 bit

3.2.2.37. AT+WANN

- Function: set/query STA network setting, setting is valid after reset.
- Format
 - ◆ Query operation

```
AT+WANN<CR>
```

```
+ok=<mode,address,mask,gateway><CR><LF><CR><LF>
```
 - ◆ Set operation

```
AT+WANN=< mode,address,mask,gateway ><CR>
```

```
+ok<CR><LF><CR><LF>
```
- Parameter
 - ◆ mode: STA's IP network setting
 - ◇ static: static IP
 - ◇ DHCP: dynamic IP
 - ◆ address: STA IP address.
 - ◆ mask: STA subnet mask
 - ◆ gateway: STA gateway address

3.2.2.38. AT+WSMAC

- Function: set/query STA MAC parameter, setting is valid after reset
- Format
 - ◆ Query operation

```
AT+WSMAC<CR>
```

```
+ok=<mac_address><CR><LF><CR><LF>
```
 - ◆ Set operation

```
AT+WSMAC=<code,mac_address><CR>
```

```
+ok<CR><LF><CR><LF>
```
- Parameter
 - ◆ code: security code
 - ◇ 8888 (default value) .
 - ◆ mac_address: STA MAC address e.g. : ACCF23FF1234

3.2.2.39. AT+BTMAC

- Function: set/query Bluetooth MAC parameter, setting is valid after reset
- Format

- ◆ Query operation

AT+BTMAC<CR>

+ok=<mac_address><CR><LF><CR><LF>

- ◆ Set operation

AT+BTMAC=<code,mac_address><CR>

+ok<CR><LF><CR><LF>

- Parameter

- ◆ code: security code
 - ◇ 8888 (default value)。
- ◆ mac_address: Bluetooth MAC address e.g.: ACCF23FF1234

3.2.2.40. AT+WSLK

- Function :query STA wireless link status

- Format

- ◆ Query operation

AT+WSLK<CR>

+ok=<ret><CR><LF><CR><LF>

- Parameter

- ◆ ret
 - ◇ if no connect, feedback “Disconnected”
 - ◇ if connected ,feedback “AP SSID (AP’s MAC) ”

3.2.2.41. AT+WSQL

- Function: query AP Wi-Fi signal strength

- Format

- ◆ Query operation

AT+WSQL<CR>

+ok=<ret><CR><LF><CR><LF>

- Parameter

- ◆ ret
 - ◇ if no connect, feedback “Disconnected”
 - ◇ if connected ,feedback Wi-Fi signal strength

3.2.2.42. AT+WSCAN

- Function: scan AP

- Format

- ◆ Query operation

AT+WSCAN<CR>

+ok=<ap_site><CR><LF><CR><LF>

- Parameter

- ◆ ap_site: searched AP site

3.2.2.43. AT+WSDNS

- Function: set/query STA static DNS server address
- Format :
 - ◆ Query operation
 - AT+WSDNS<CR>**
 - +ok=<address><CR><LF><CR><LF>**
 - ◆ Set operation
 - AT+WSDNS =<address><CR>**
 - +ok<CR><LF><CR><LF>**
- Parameter
 - ◆ address: STA's DNS server address, effective immediately

3.2.2.44. AT+UPURL

- Function: set/query remote upgrade URL address
- Format
 - ◆ Query
 - AT+UPURL<CR>**
 - +ok=<url><CR><LF><CR><LF>**
 - ◆ Set operation
 - AT+UPURL =<url,filename><CR>**
 - +ok<CR><LF><CR><LF>**
- Parameter
 - ◆ url: the upgrade file located URL address. Note: there should be '/' in the tail, utmost support 100 bytes
 - ◆ filename: upgrade file name, may choose not save. If provide this file name here, the module will start upgrade right away;.

3.2.2.45. AT+UPFILE

- Function: set/query remote upgrade file name
- format
 - ◆ query operation
 - AT+UPFILE<CR>**
 - +ok=<filename ><CR><LF><CR><LF>**
 - ◆ set operation
 - AT+UPFILE =<filename><CR>**
 - +ok<CR><LF><CR><LF>**
- parameter
 - ◆ filename: the upgrade configure file name (please add suffix and within 20 character)

3.2.2.46. AT+LOGSW

- Open/close remote upgrade log file
- Format

- ◆ Query operation

AT+LOGSW<CR>

+ok=<status><CR><LF><CR><LF>

- ◆ Set operation

AT+LOGSW=<status><CR>

+ok<CR><LF><CR><LF>

- Parameter

- ◆ status:

- ✧ on: Open. The UART Port will print some upgrade status when upgrading. the log file will be sent to fixed UDP Port after succeed
- ✧ off: close

3.2.2.47. AT+LOGPORT

- Function :set/query remote upgrade UDP port of log file

- Format

- ◆ Query operation

AT+LOGPORT<CR>

+ok=<port><CR><LF><CR><LF>

- ◆ Set operation

AT+LOGPORT =<port><CR>

+ok<CR><LF><CR><LF>

- Parameter

- ✧ port: the remote upgrade USP port of log file

3.2.2.48. AT+UPST

- Function: start remote upgrade

- Format

- ◆ Query operation

AT+UPST<CR>

+ok=<log><CR><LF><CR><LF>

- Parameter

- ◆ log: feedback the status of remote upgrade

Note: After execute this command, the HF-LPC100 will automatic start upgrade base on the setting of UPURL, UPFILE like URL address and configure file name. after upgrade succeeded , module will restart automatically

3.2.2.49. AT+MSLP

- Function: Set/Query deep sleep /standby mode parameter

- Format

- ◆ Query operation

AT+MSLP<CR>

+ok=<ret><CR><LF><CR><LF>

- ◆ Set operation

AT+MSLP=<mode><CR>

+ok<CR><LF><CR><LF>

- parameter
 - ◆ ret:
 - ◇ normal: normal work
 - ◆ mode:
 - ◇ normal: normal mode
 - ◇ standby: Wi-Fi shutdown mode (reserved function)

3.2.2.50. AT+NTPRF

- Function: set/query time calibration interval
- format
 - ◆ query operation

AT+NTPRF<CR>

+ok=<num><CR><LF><CR><LF>

- ◆ set operation

AT+NTPRF=<num><CR>

+ok<CR><LF><CR><LF>

- parameter
 - ◆ num: time calibration interval, range:0~720, default:30 minutes, 10 minutes for each step, set 0 means no time calibration

3.2.2.51. AT+NTPEN

- Function: enable/disable time calibration function. Setting is valid after reset.
- Format
 - ◆ Query operation

AT+NTPEN<CR>

+ok=<status><CR><LF><CR><LF>

- ◆ Set operation

AT+NTPEN=<status><CR>

+ok<CR><LF><CR><LF>

- Parameter
 - ◆ status: status of time calibration
 - on: enable time calibration
 - off: disable time calibration

3.2.2.52. AT+NTPTM

- Function: query network time
- Format
 - ◆ Query operation

AT+NTPTM<CR>

+ok=<time><CR><LF><CR><LF>

- Parameter

- ◆ time: network time, for example: 2013-10-9 16:10:42 Wed, if it shows Not Available means that the time calibration function is not enabled or the module doesn't connect to the internet.

3.2.2.53. AT+NTPSER

- Function: set /query NTP server IP address
- Format
 - ◆ Query operation

```
AT+NTPSER<CR>
```

```
+ok=<ipaddress><CR><LF><CR><LF>
```
 - ◆ Set operation

```
AT+NTPEN=< ipaddress ><CR>
```

```
+ok<CR><LF><CR><LF>
```
- Parameter
 - ◆ ipaddress: NTP network server IP address. 61.164.36.105 (default value)

3.2.2.54. AT+WRMID

- Function set module ID
- Format
 - ◆ Set operation

```
AT+WRMID =<wrmid><CR>
```

```
+ok<CR><LF><CR><LF>
```
- Parameter
 - ◆ wrmid: set module's ID (within 20 characters).

3.2.2.55. AT+RLDEN

- Function: set/query nReload function
- Format
 - ◆ Query operation

```
AT+RLDEN<CR>
```

```
+ok=<status><CR><LF><CR><LF>
```
 - ◆ Set operation

```
AT+RLDEN=<status><CR>
```

```
+ok<CR><LF><CR><LF>
```
- Parameter
 - ◆ status: the status of nReload function:
 - ◇ on: nReload pin function is enabled
 - ◇ off: nReload pin function is disabled

3.2.2.56. AT+ASWD

- Function: set/query Wi-Fi configuration password
- Format
 - ◆ Query operation

```
AT+ASWD<CR>
```

+ok=<aswd><CR><LF><CR><LF>

- ◆ set operation

AT+ASWD =<aswd><CR><LF><CR><LF>

- Parameter
 - ◆ aswd: Wi-Fi Configuration Password (within 20 characters)., **default is HF-A11ASSISTHREAD**

3.2.2.57. AT+MDCH

- Function: set Wi-Fi auto switch function. Setting is valid after reset.
- Format
 - ◆ Query operation

AT+MDCH<CR>

+ok=<mode><CR><LF><CR><LF>

- ◆ set operation

AT+MDCH=<mode><CR><LF><CR><LF>

- Parameter
 - ◆ mode: Wi-Fi auto switch mode
 - off: disable Wi-Fi auto switch
 - on: Enable Wi-Fi auto switch. When the module(STA mode) fail to connect to router, it will switch to AP mode itself in one minute.
 - Auto: Enable Wi-Fi auto detect function. The module will reset itself when encounter any abnormal. The default time interval is 10 minutes. **(default mode)**
 - 3-120: unit: minute. Set the time interval to reset itself when abnormal.

3.2.2.58. AT+TXPWR

- Function : Set/Query Wi-Fi Transmit Power, Real Transmit Power=Default Transmit Power(16dBm) – [Setting Value] * 0.5dBm. Setting is valid after reset.
- Format
 - ◆ Query operation

AT+TXPWR <CR>

+ok=<num><CR><LF><CR><LF>

- ◆ set operation

AT+TXPWR=<num><CR>

+ok<CR><LF><CR><LF>

- Parameter
 - ◆ num: offset value. The default is 0, it can be sent from 0 ~ 24. If set to 24, the module transmit power will be at a minimum of 4dBm. Reboot to make this setting change valid. It will not restore to default if reload the module.

3.2.2.59. AT+SMTLK

- Function: start smart link function
- Format
 - ◆ Query operation

AT+SMTLK<CR>

SmartLink is a One-Key config function. Config the module connecting to router easily. After start SmartLink function , the module work in SmartLink status and nLink LED is fast flashing waiting for APP to push information. See the Appendix for more details.

3.2.2.60. AT+LPTIO

- Function: : nReady、nLink、WPS function mapping, setting is valid after reset

- Format

- ◆ Query operation

AT+LPTIO<CR>

+ok=<status><CR>< LF><CR>< LF>

- ◆ set operation

AT+LPTIO=<status><CR>

+ok<CR>< LF><CR>< LF>

- parameter

- ◆ staus: nReady、nLink、WPS function mapping

- **off/lpb100 (default)** : nReady、nLink、WPS function are mapping to HF-LPC100 corresponding pin (Pin44、Pin43、Pin15) 。
- **on/lpt100**: nReady、nLink、WPS function are mapping to HF-LPT100 corresponding pin (Pin9、Pin10、Pin8) 。
- **lpt200**: nReady、nLink、WPS are mapping to HF-LPT200 corresponding pin (Pin11、Pin13、Pin14) 。

4. PACKAGE INFORMATION

4.1. Recommend Reflow Profile

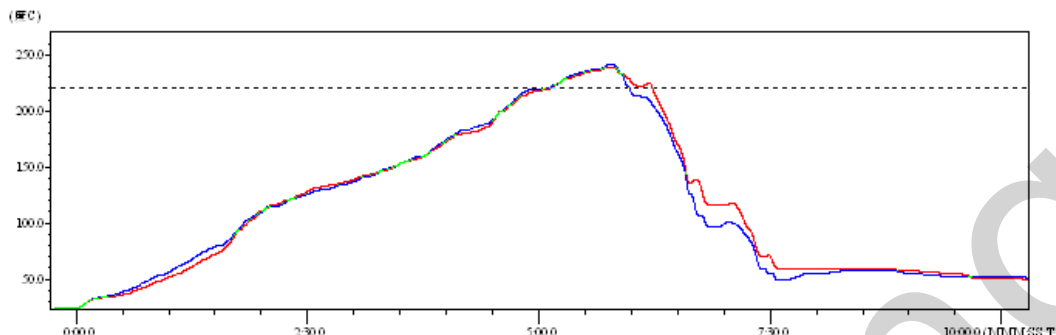

Figure 14. Reflow soldering profile

Table 12 reflow soldering parameter

No.	item	Temp (°C)	time(sec)
1	Reflow time	220 °C above	35~55sec
2	Peak temp	Max 260°C	

- Note:**
1. Recommend to supply N2 for reflow oven.
 2. N2 atmosphere during reflow (O2<300ppm)

4.2. Device Handling Instruction (Module IC SMT Preparation)

- Shelf life in sealed bag: 12 months, at <30°C and <60% relative humidity (RH)
 - After bag is opened, devices that will be re-baked required after last baked with window time 168 hours.
 - Recommend to oven bake with N2 supplied
 - Recommend end to reflow oven with N2 supplied
 - Baked required with 24 hours at 125+/-5°C before rework process for two modules, one is new module and two is board with module
 - Recommend to store at ≦ 10% RH with vacuum packing
 - If SMT process needs twice reflow:
 - (1) Top side SMT and reflow □ □ (2) Bottom side SMT and reflow
- Case 1: Wifi module mounted on top side. Need to bake when bottom side process over 168 hours window time, no need to bake within 168 hours
- Case 2: Wifi module mounted on bottom side, follow normal bake rule before process

Note: Window time means from last bake end to next reflow start that has 168 hours space.

4.3. Shipping Information

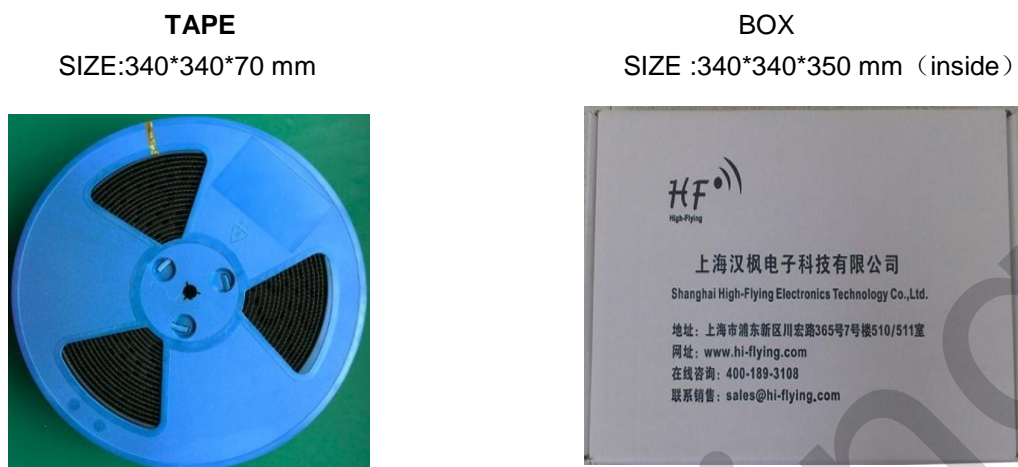

Figure 15. Shipping information

Note :

1 tape = 500pcs

1 box= 5 tape = 5 * 500pcs= 2500pcs

APEENDIX A: HARD REFERENCE DESIGN

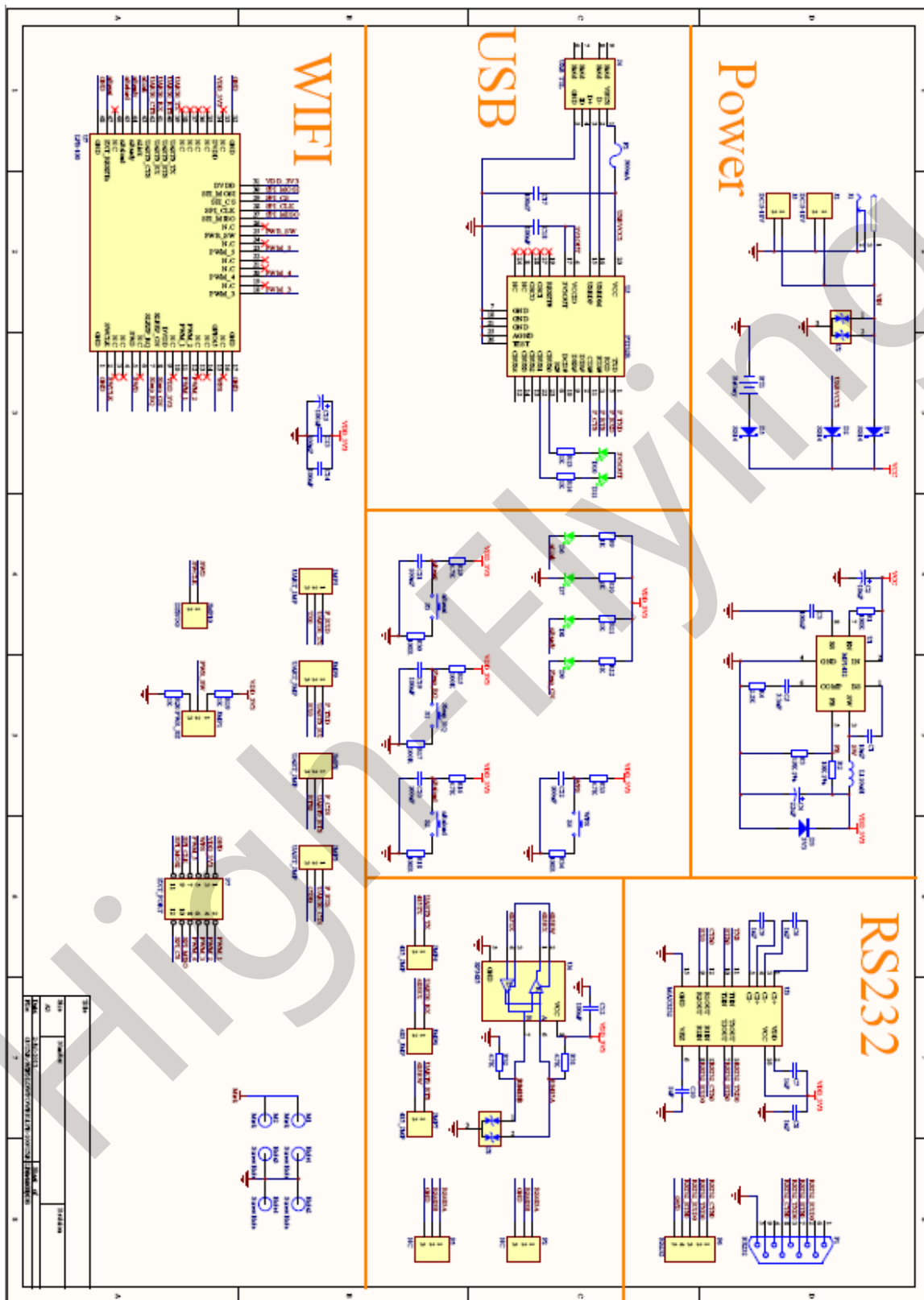

Detailed HF-LPC100 Evaluation Board design source files, pls access High-Flying web download page or contact with High-Flying technical support people to acquire.

APPENDIX B: CONTROL GPIO、 PWM FUNCTION WITH NETWORK COMMAND(TBD)

Send command data to control module’s GPIO, PWM port after make network connection with TCP or UDP protocol.(module must at PWM mode) The status of GPIO won’t be changed if the module is reset

B.1 Network Command

B.1.1 GPIO <channel> OUT <value>

- function: set module GPIO channel output temporary value, valid after save and reset
- parameter
 - ◆ channel: GPIO channel number, can be 11、 12、 15、 18、 20、 23(GPIO pin number)
 - ◆ value: GPIO channel value, 1(high voltage), 0(low voltage)
- return data:
 - ◆ GPIO OK: command succeed
 - ◆ GPIO NOK: command failed

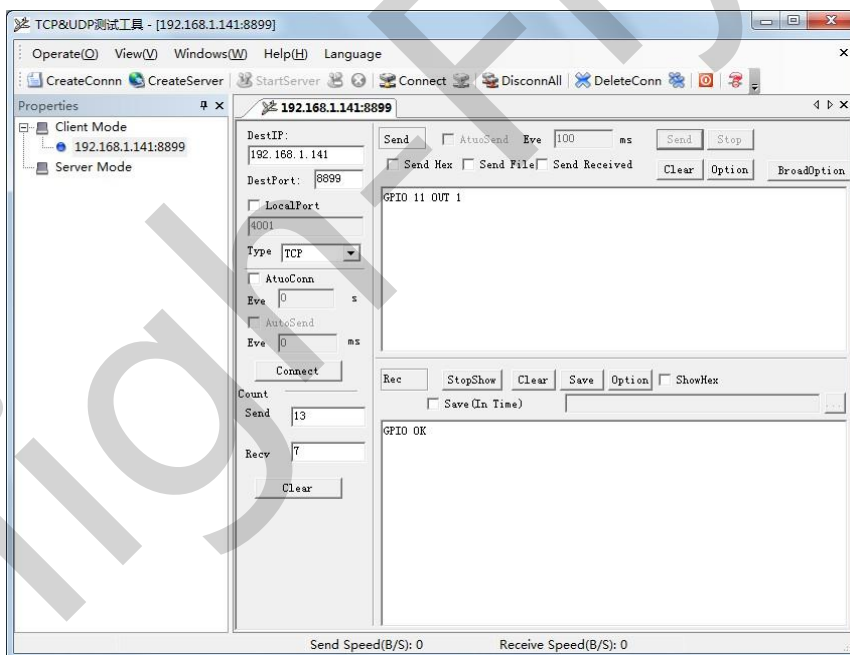

B.1.2 GPIO <channel> GET

- Function: query GPIO channel value
- Parameter
 - ◆ channel: GPIO channel number, can be 11、 12、 15、 18、 20、 23(GPIO pin number)
- return data
 - ◆ +ok=<value>

- value: GPIO channel value
- ◆ GPIO NOK: command failed

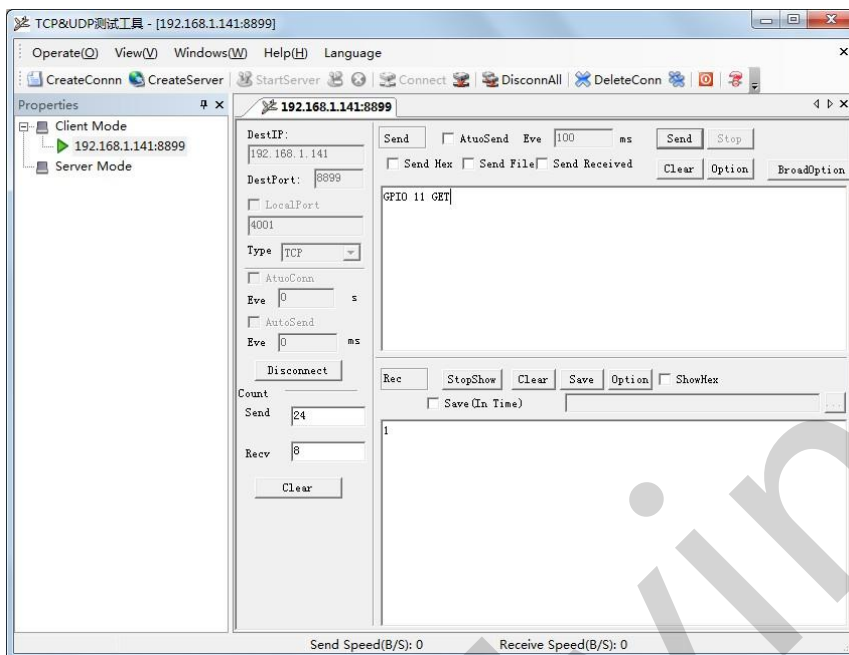

B.1.3 GPIO <channel> SET

- Function : save GPIO channel value
- Parameter :
 - ◆ channel: GPIO channel number, can be 11、12、15、18、20、23(GPIO pin number)
- return data
 - ◆ GPIO OK: command succeed
 - ◆ GPIO NOK: command failed

B.1.4 PWM <channel frequency duty>

- Function: set PWM channel output channel temporary value, valid after save and reset
- Parameter
 - ◆ channel: PWM channel number , can be 11、12、18、20(GPIO pin number)
 - ◆ frequency: PWM frequency value, 500~60000
 - ◆ duty: PWM duty, 0~100
- return data:
 - ◆ PWM OK: command succeed
 - ◆ PWM NOK: command failed

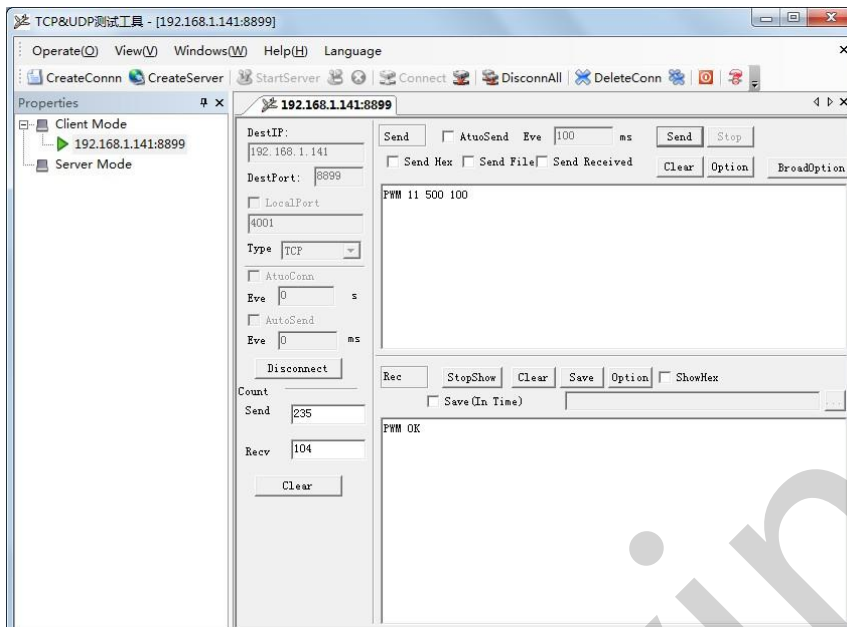

B.1.5 PWM <channel> GET

- Function: query PWM channel output value
- Parameter
 - ◆ channel: PWM channel number, can be 11、12、18、20(GPIO pin number)
- return data
 - ◆ +ok=<frequency duty>
 - frequency: PWM channel frequency
 - duty: PWM channel duty
 - ◆ PWM NOK: command failed

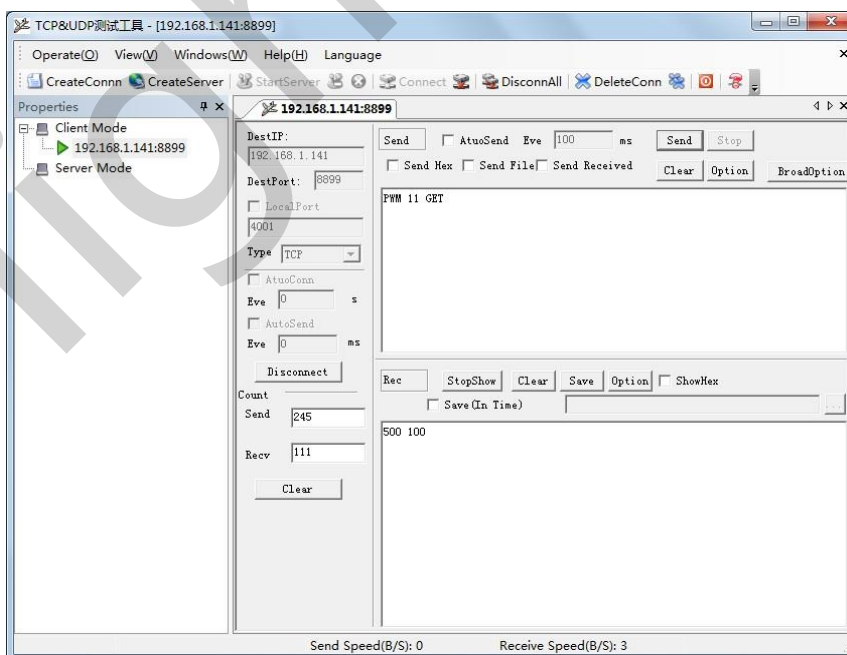

B.1.6 PWM <channel> SET

- Function : save PWM channel output value
- Parameter
 - ◆ channel: PWM channel number, can be 11、12、18、20(GPIO pin number)
- return data
 - ◆ PWM OK: command succeed
 - ◆ PWM NOK: command failed

B.2 Hexadecimal Network Command

Send hexadecimal data to quickly read module's I/O status, send area and receive area must send and receive based on hexadecimal.

B.2.1 Read all GPIO channel

- Send data 【0a】 :
- return data: 【8a <value>】
 - ◆ value: bit0、bit1 represent GPIO15、GPIO23 value

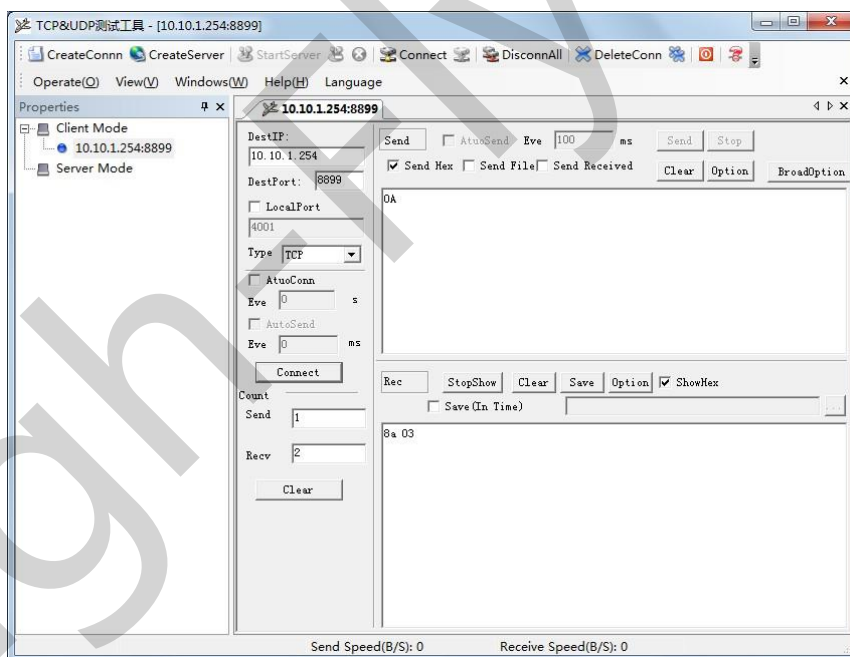

B.2.2 Reverse GPIO Channel value

- Send Data 【03 <channel>】 :
 - ◆ channel: GPIO Channel number, it can be 01、02(GPIO15、GPIO23)
- Return Data: 【83 <channel value>】
 - ◆ channel: GPIO Channel number, it can be 01、02(GPIO15、GPIO23)
 - ◆ value: GPIO Channel value, 0 or 1

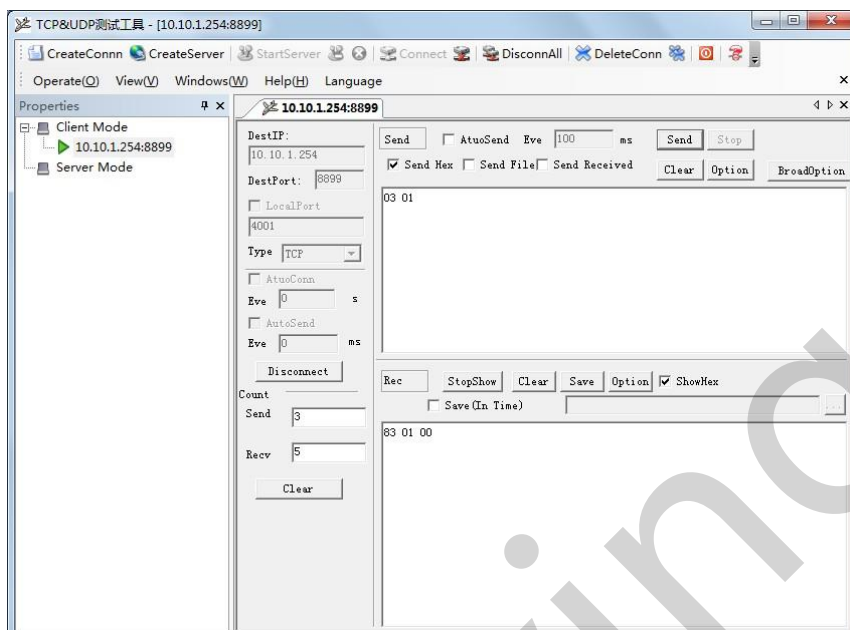

B.2.3 Read All PWM Channel Frequency

- Send Data: **【30】** :
- Return Data: **【b0 <value1 value2 value3 value4 value5 value6 value7 value8>】**
 - ◆ value1: High byte of PWM Channel 0(GPIO11) frequency
 - ◆ value2: Low byte of PWM Channel 0(GPIO11) frequency
 - ◆ value3: High byte of PWM Channel 1(GPIO12) frequency
 - ◆ value4: Low byte of PWM Channel 1(GPIO12) frequency
 - ◆ value5: High byte of PWM Channel 2(GPIO18) frequency
 - ◆ value6: Low byte of PWM Channel 2(GPIO18) frequency
 - ◆ value7: High byte of PWM Channel 3(GPIO20) frequency
 - ◆ value8: Low byte of PWM Channel 3(GPIO20) frequency

B.2.4 Write PWM Channel Frequency

- Send Data: **【32 <channel value1 value2】** :
 - ◆ channel: PWM Channel number
 - ◆ value1: High byte of PWM Channel frequency
 - ◆ value2: Low byte of PWM Channel frequency
- Return Data: **【b2 <channel value1 value2>】**
 - ◆ Channel: PWM Channel number
 - ◆ value1: High byte of PWM Channel frequency
 - ◆ value2: Low byte of PWM Channel frequency

B.2.5 Read All PWM Channel Duty

- Send Data: **【20】** :
- Return Data: **【a0 <value1 value2 value3 value4>】**
 - ◆ value1: Duty of PWM Channel 0
 - ◆ value2: Duty of PWM Channel 1
 - ◆ value3: Duty of PWM Channel 2

- ◆ value4: Duty of PWM Channel 3

B.2.6 Write All PWM Channel Duty

- Send Data: **【24 <value1 value2 value3>】** :
- Return Data: **【a4 <value1 value2 value3>】**
 - ◆ value1: Duty of PWM Channel 0
 - ◆ value2: Duty of PWM Channel 1
 - ◆ value3: Duty of PWM Channel 2

B.2.7 Write PWM Channel Duty

- Send Data: **【22 <channel value1>】** :
 - ◆ channel: PWM Channel number
 - ◆ value1: Duty of PWM Channel
- Return Data: **【a2 <channel value1>】**
 - ◆ Channel: PWM Channel number
 - ◆ value1: Duty of PWM Channel

B.2.8 Save Present GPIO,PWM Setting

- Send Data: **【7a】** :
- Return Data: **【fa】**

B.2.9 Assert All GPIO Channel Low

- Send Data: **【04】** :
- Return Data: **【84 00】**

B.2.10 Assert All GPIO Channel High

- Send Data: **【05】** :
- Return Data: **【85 01】**

B.2.11 Read Resources of module

- Send Data: **【7e】** :
- Return Data: **【fe <value1 value2 value3>】**
 - ◆ value1: Module's GPIO output pin number .
 - ◆ value2:Module's GPIO input pin number
 - ◆ value3:Module's PWM pin number

APPENDIX C: HTTP PROTOCOL TRANSFER

HF-LPB100 module support http data transfer in command mode. If any detailed HTTP protocol, contact us and we may support customization.

C.1. HTTP AT Command

C.1.1. AT+HTTPURL

- Function: Set /Query HTTP server IP address and Port Number.
- Format:
 - ◆ Query Operation

```
AT+HTTPURL<CR>
+ok=<IP,Port><CR><LF><CR><LF>
```
 - ◆ Set Operation

```
AT+HTTPURL=<IP,Port><CR>
+ok<CR><LF><CR><LF>
```
- Parameters:
 - ◆ IP: IP address.
 - ◆ Port: Port number.

C.1.2. AT+HTTPTP

- Function: Set /Query HTTP request type
- Format:
 - ◆ Query Operation

```
AT+HTTPTP<CR>
+ok=<Type><CR><LF><CR><LF>
```
 - ◆ Set Operation

```
AT+HTTPTP=<Type><CR>
+ok<CR><LF><CR><LF>
```
- Parameters:
 - ◆ Type: GET(default) or POST.

C.1.3. AT+HTTTPH

- Function: Set/Query HTTP protocol header path.
- Format:
 - ◆ Query Operation

```
AT+HTTTPH<CR>
+ok=<Path><CR><LF><CR><LF>
```
 - ◆ Set Operation

```
AT+HTTTPH=<Path><CR>
+ok<CR><LF><CR><LF>
```

- Parameters:
 - ◆ Path: Max length is 50 bytes.

C.1.4. AT+HTTPCN

- Function: Set/Query Connection of HTTP protocol header
- Format:

- ◆ Query Operation

AT+HTTPCN<CR>

+ok=<Connection><CR><LF><CR><LF>

- ◆ Set Operation

AT+HTTPCN=<Connection><CR>

+ok<CR><LF><CR><LF>

- Parameters:
 - ◆ Connection: Max length is 20 bytes.

C.1.5. AT+HTTTPUA

- Function: Set/Query User-Agent of HTTP protocol header.
- Format:

- ◆ Query Operation

AT+HTTTPUA<CR>

+ok=<Parameter><CR><LF><CR><LF>

- ◆ Set Operation

AT+HTTTPUA=<Parameter><CR>

+ok<CR><LF><CR><LF>

- Parameters:
 - ◆ Parameter: Max length is 20 bytes.

C.1.6. AT+HTTPDPT

- Function: Send HTTP request or data.
- Format:

- ◆ Set Operation

AT+HTTPDPT=<Data><CR>

+ok<CR><LF><CR><LF>

- Parameters:
 - ◆ Data: HTTP request data, send AT+HTTPDPT directly if no data to be sent.

C.2. HTTP Example

HTTP parameter settings are as follows:

AT+HTTPURL=192.168.1.1,80	Set HTTP server address and port
AT+HTTPPTP=POST	Set HTTP request type
AT+HTTTPPH=/abcd	Set HTTP protocol header path
AT+HTTPCN= keep-alive	Set HTTP Connection area
AT+HTTTPUA= lwip1.3.2	Set HTTP User-Agent area

If send “AT+HTTPD”, the data packet will be sent as the following instance including the two new line:

```
POST /abcd HTTP/1.1
Connection:keep-alive
User-Agent:lwp1.3.2
Content-Length:0
Host:192.168.0.127:8999
```

If send AT+HTTPD=abcd, the data packet will be sent as the following instance:

```
POST /abcd HTTP/1.1
Connection:keep-alive
User-Agent:lwp1.3.2
Content-Length:4
Host:192.168.0.127:8999
```

abcd

The data received from HTTP server will be output to serial port and end with “+ok”.

If the module hasn't received data from HTTP server for 5 second, it will cut the TCP link with HTTP server.

APPENDIX D: BLUETOOTH ONE-KEY CONFIGURATION

➤ APP download

IOS /Android



Hi-Flying Getway使用指南
2014-11-10



[APP工具]SmartLinkV4.4X
2014-10-24



[APP工具]SmartLinkV3.7(IOS)
2014-10-20



生产工具 双棍生产升级工具
2014-08-30

IOS APP download address: <http://www.pgyer.com/bNwD>

Android APP download address: <http://www.pgyer.com/5zg5>

Step 1: after installation, user can find below icon shows on smart terminal



Step 2: press 【nReload】 on LPC100 module to start Bluetooth one-key configuration. After module restart, the 【nLink】 led twinkle slowly indicate that the Bluetooth is opened

Step 3: mobile connect to router and open Bluetooth, then connect to module Bluetooth.

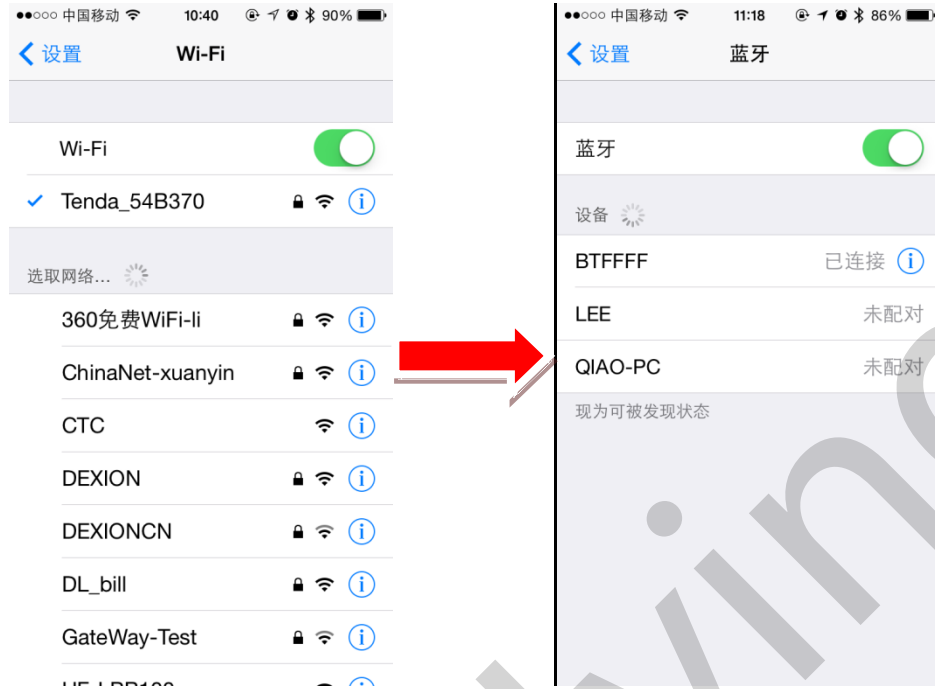

Note: module's default Bluetooth name is BTFFFF(BT+ last four byte of MAC address), user can revise MAC address via AT+BTMAC=8888,XXXXXXXXXXXX.

Step 4: click APP icon and enter the main page

SSID: the mobile connected router's SSID

Password : router's password



Step 5: press APP 【开始连接】 (start connect) button , sending the configuration information to module. After configuration, module will restart automatically and switch to STA module to connect router .

- nLink light stays on, indicate the module already connected to router
- if configure failed, nLink is off, require configure again.

Note:

- 1、 after Bluetooth configure finished, APP will continue sending configuration information in sonic way.
- 2、 if require configure again, for the IOS device already connected via Bluetooth require connect again, user must 【忽略此设备】 (ignore this device) and reconnect ; for android device, there is no such limitation.



3、High Flying Wi-Fi module recommended hardware connection

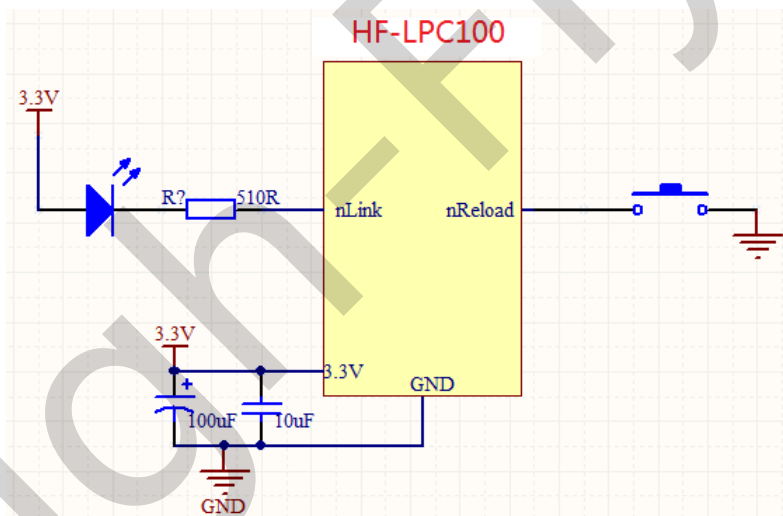

nReload: press this button when use smart configure
 nLink: link status indicator

APPENDIX E: HF-LPX SERIES MODULE PIN COMPATIBLE TABLE

	HF-LPB100	HF-LPT100	HF-LPT200	HF-LPB100U	HF-LPC100
1	GND	1	16	GND	GND
2	SWCLK			SWCLK	SWCLK
3	N.C			N.C	N.C
4	N.C			N.C	N.C
5	SWD			SWD	SWD
6	N.C			N.C	N.C
7	GPIO7		14	GPIO7(AD)	N.C
8	GPIO8			GPIO8(AD,PWM5 N)	N.C
9	DVDD	2	15	DVDD	DVDD
10	N.C			N.C	N.C
11	GPIO11	10		DAC RO	N.C
12	GPIO12	9		DAC LO	N.C
13	GPIO13			MIC IN	N.C
14	N.C			N.C	N.C
15	GPIO15 (WPS)			GPIO15	N.C
16	N.C			N.C	N.C
17	GND			GND	GND
18	GPIO18	8		GPIO18(PWM7)	N.C
19	N.C			N.C	N.C
20	GPIO20			GPIO20	N.C
21	N.C			N.C	N.C
22	N.C			N.C	N.C
23	GPIO23		9	PWR SW	PWR SW
24	N.C			N.C	N.C
25	PWR SW	7		USB D+(GPIO)	USB D+(GPIO)
26	N.C			USB D-(GPIO)	USB D-(GPIO)
27	SPI MISO		3	GPIO27(AD)	GPIO27
28	SPI CLK		2	N.C	N.C
29	SPI CS		4	UART1 RX(AD,PWM5 P)	N.C
30	SPI MOSI		1	UART1 TX(AD,PWM6)	GPIO30
31	DVDD			DVDD	DVDD
32	GND			GND	GND
33	N.C			N.C	N.C
34	DVDD			DVDD	DVDD
35	N.C			GPIO35 (WPS)	GPIO35 (WPS)
36	N.C			N.C	N.C
37	N.C			N.C	N.C
38	N.C			N.C	N.C
39	UART0 TX	6	5	UART0 TX	UART0 TX
40	UART0 RTS		8	UART0 RTS	N.C
41	UART0 RX	5	6	UART0 RX	UART0 RX
42	UART0 CTS		7	UART0 CTS(PWM1)	N.C
43	nLink		13	nLink(AD,PWM4)	nLink
44	nReady		11	nReady(AD,PWM3)	nReady
45	nReload	3	12	nReload(PWM2)	nReload
46	N.C			N.C	N.C
47	EXT RESETn	4	10	EXT RESETn	EXT RESETn
48	GND			GND	GND
			17(ANT)		

APPENDIX F: CONTACT INFORMATION

Address: Room 1002, Building 1, No.3000, Longdong Avenue, Pudong
New Area, Shanghai, China, 201203
Web: www.hi-flying.com
Online service: 400-189-3108
Email: sales@hi-flying.com

or more information about High-Flying modules, applications, and solutions, please visit our web site
<http://www.hi-flying.com/en/>

<END>

© Copyright High-Flying, May, 2011

The information disclosed herein is proprietary to High-Flying and is not to be used by or disclosed to unauthorized persons without the written consent of High-Flying. The recipient of this document shall respect the security status of the information.

The master of this document is stored on an electronic database and is "write-protected" and may be altered only by authorized persons at High-Flying. Viewing of the master document electronically on electronic database ensures access to the current issue. Any other copies must be regarded as uncontrolled copies.