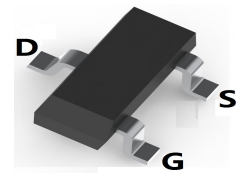
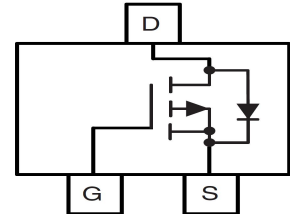

LOW VOLTAGE MOSFET (P-CHANNEL)
FEATURES

- $V_{DS}=-12V, R_{DS(ON)} \leq 45m\Omega @ V_{GS}=-4.5V, I_D=-4.1A$
- Low on-resistance
- For DC to DC converter and Load switch applications
- Surface Mount device

SOT-23

MECHANICAL DATA

- Case: SOT-23
- Case Material: Molded Plastic. UL flammability
- Classification Rating: 94V-0
- Weight: 0.008 grams (approximate)

MAXIMUM RATINGS ($T_A = 25^\circ C$ unless otherwise noted)

Parameter	Symbol	Value	Unit
Drain-source voltage	V_{DS}	-12	V
Gate-source voltage	V_{GS}	± 8	V
Continuous drain current	I_D	-4.1	A
Continuous source-drain diode current	I_S	-0.8	A
Power dissipation	P_D	0.35	W
Thermal resistance from Junction to ambient ($t \leq 10s$)	$R_{\theta JA}$	357	$^\circ C/W$
Junction temperature	T_J	150	$^\circ C$
Storage temperature	T_{STG}	-55 ~ +150	$^\circ C$

ELECTRICAL CHARACTERISTICS ($T_A = 25^\circ C$ unless otherwise specified)

Parameter	Symbol	Min	Typ	Max	Unit	Conditions
Drain-Source breakdown voltage	$V_{(BR)DSS}$	-12			V	$V_{GS}=0V, I_D=-250\mu A$
Zero gate voltage drain current	I_{DSS}			-1	μA	$V_{DS}=-8V, V_{GS}=0V$
Gate-body leakage current	I_{GSS}			± 100	nA	$V_{DS}=0V, V_{GS}=\pm 8V$
Gate-threshold voltage (note 1)	$V_{GS(th)}$	-0.5		-0.9	V	$V_{DS}=V_{GS}, I_D=-250\mu A$
Drain-source on-resistance (note 1)	$R_{DS(ON)}$		30	45	m Ω	$V_{GS}=-4.5V, I_D=-3.5A$
			75	190	m Ω	$V_{GS}=-2.5V, I_D=-3A$
			115	330	m Ω	$V_{GS}=-1.8V, I_D=-2.0A$
Forward transconductance (note 1)	g_{FS}	6			S	$V_{DS}=-5V, I_D=-4.1A$
Gate resistance	R_g	1.4	7	14	Ω	$f=1MHz$
Input capacitance	C_{ISS}		740		pF	$V_{DS}=-4V, V_{GS}=0V, f=1MHz$
Output capacitance	C_{OSS}		290		pF	
Reverse transfer capacitance	C_{RSS}		190		pF	
Turn-on delay time	$t_{d(on)}$		13	20	nS	$V_{DD}=-4V, I_D \approx -3.3A, V_{GEN}=-4.5V, R_g=1\Omega, R_L=1.2\Omega$
Turn-on rise time	t_r		35	53	nS	
Turn-off delay time	$t_{d(off)}$		32	48	nS	
Turn-off fall time	t_f		10	20	nS	
Turn-on delay time	$t_{d(on)}$		5	10	nS	$V_{DD}=-4V, I_D \approx -3.3A, V_{GEN}=-8V, R_g=1\Omega, R_L=1.2\Omega$
Turn-on rise time	t_r		11	17	nS	
Turn-off delay time	$t_{d(off)}$		22	33	nS	
Turn-off fall time	t_f		16	24	nS	
Total gate charge	Q_g		7.8	15	nC	$V_{DS}=-4V, V_{GS}=-4.5V, I_D=-4.1A$
			4.5	9	nC	
Gate-source charge	Q_{gs}		1.2		nC	$V_{DS}=-4V, V_{GS}=-2.5V, I_D=-4.1A$
Gate-drain charge	Q_{gd}		1.6		nC	
Diode forward voltage	V_{SD}			-1.2	V	$I_F=-3.3A, V_{GS}=0V$
Diode forward current	I_S			-1.4	A	$T_C = 25^\circ C$
Pulse diode forward current(note 1)	I_{SM}			-10	A	

Note:1. Pulse test ; Pulse width $\leq 300\mu s$, Duty cycle $\leq 2\%$.

LOW VOLTAGE MOSFET (P-CHANNEL)

Typical Characteristics

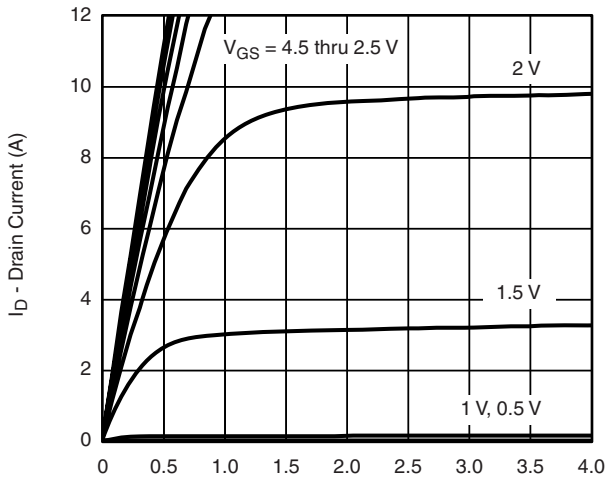

$V_{GS} = 4.5$ thru 2.5 V

Output Characteristics

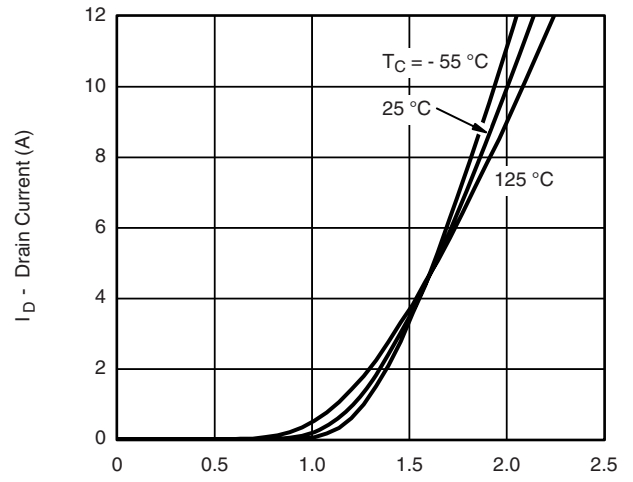

$T_C = -55^\circ\text{C}$, 25°C , 125°C

Transfer Characteristics

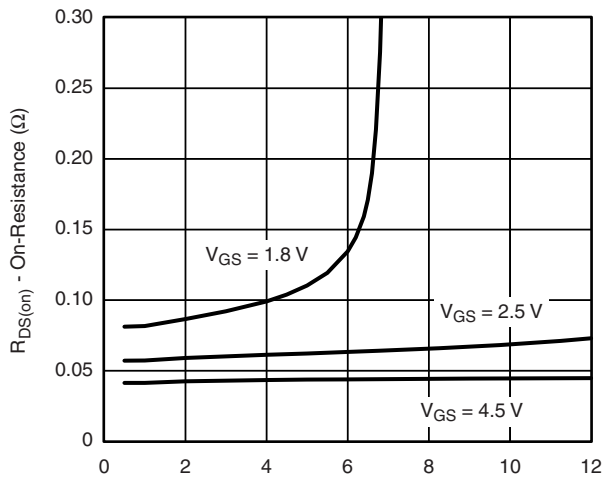

$V_{GS} = 1.8$ V, 2.5 V, 4.5 V

On-Resistance vs. Drain Current

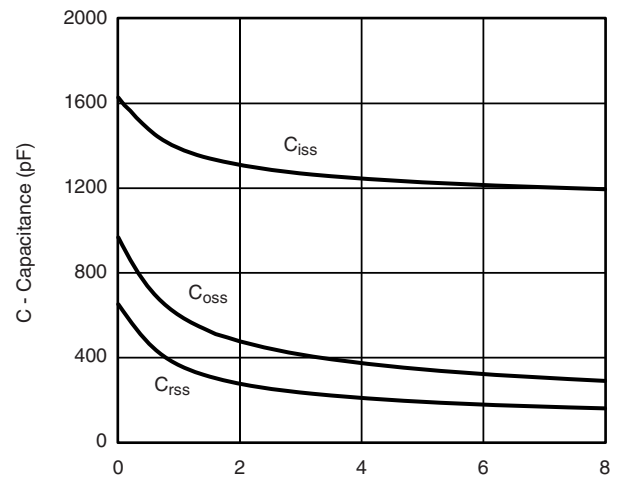

$V_{DS} = 0$ to 8 V

Capacitance

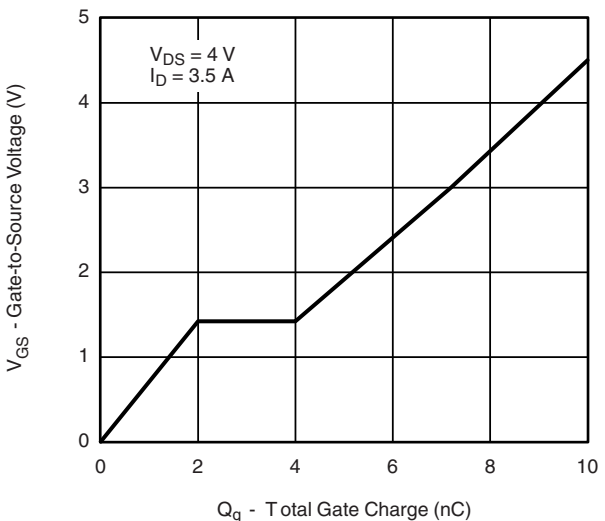

$V_{DS} = 4$ V, $I_D = 3.5$ A

Gate Charge

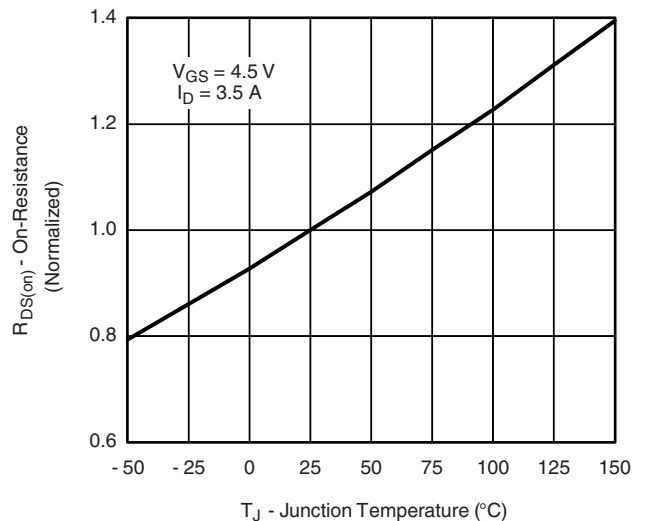

$V_{GS} = 4.5$ V, $I_D = 3.5$ A

On-Resistance vs. Junction Temperature

LOW VOLTAGE MOSFET (P-CHANNEL)

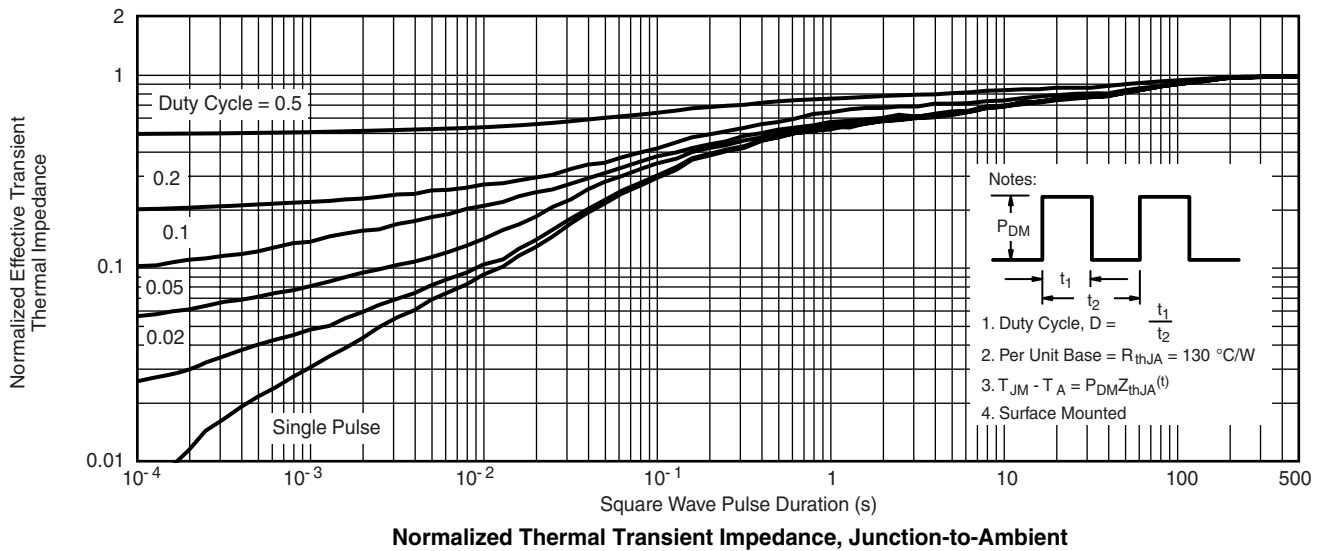
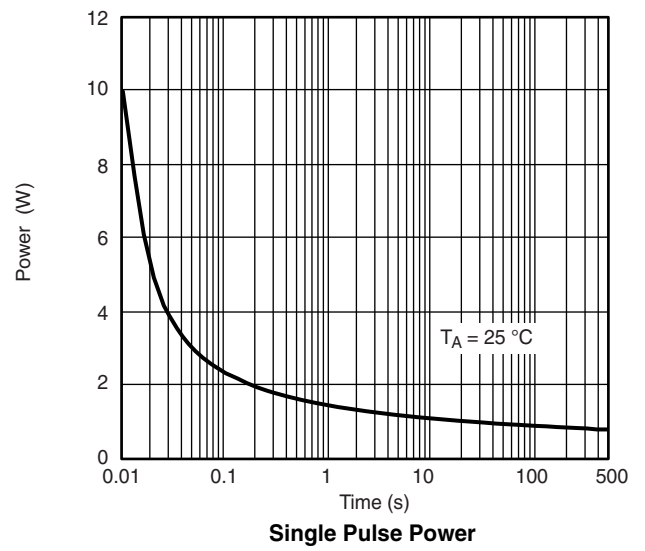
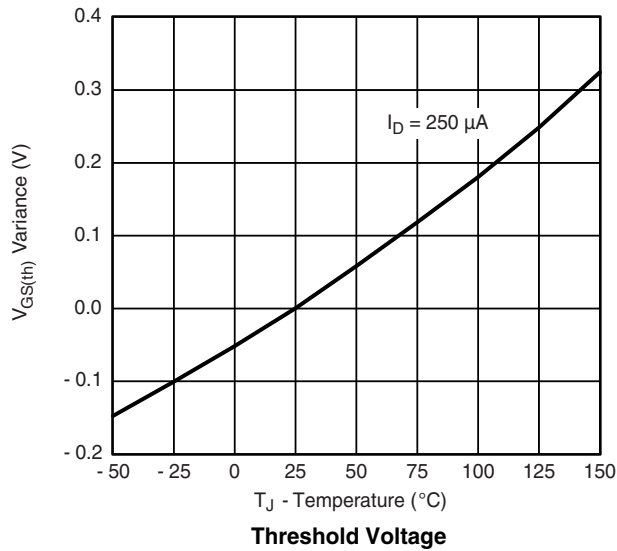
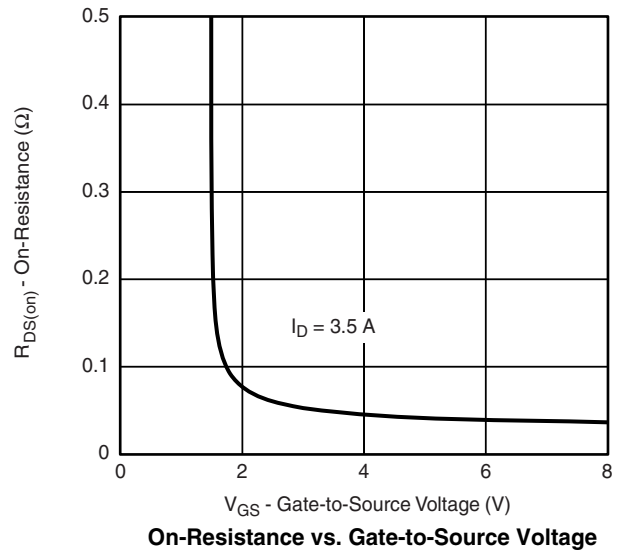
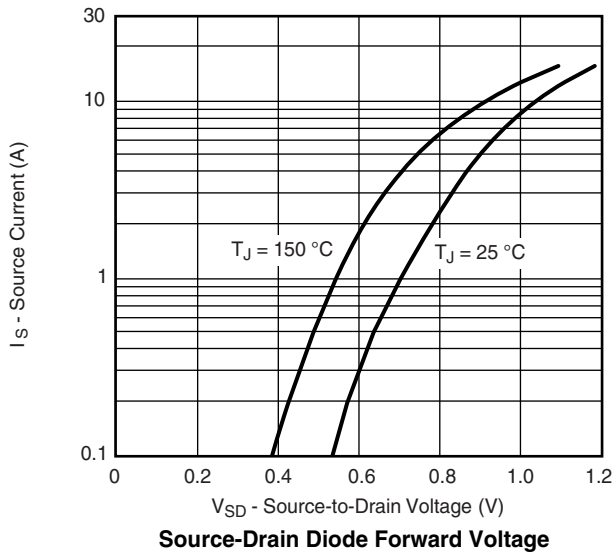

LOW VOLTAGE MOSFET (P-CHANNEL)

SOT-23 Package Outline Dimensions

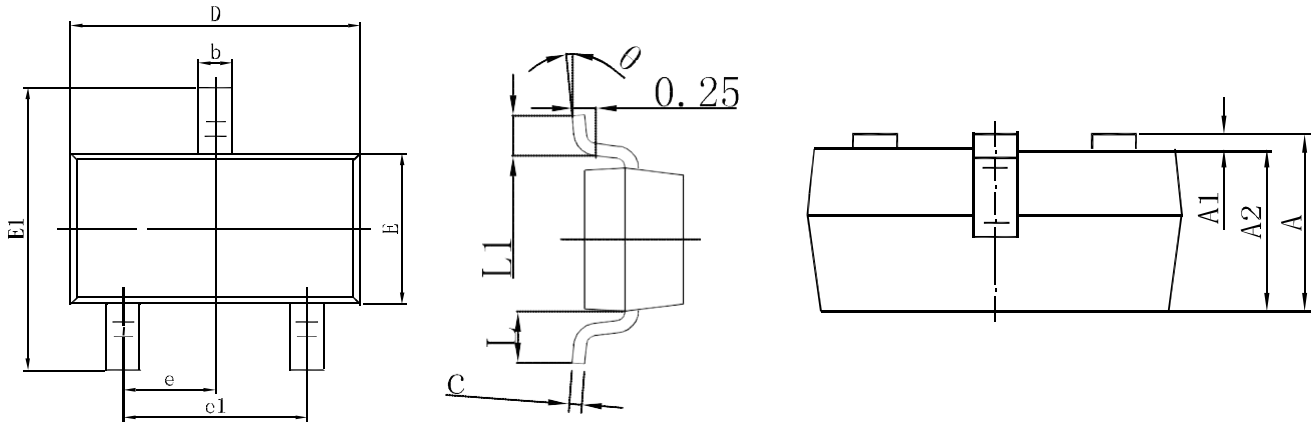

Symbol	Dimensions In Millimeters		Dimensions In Inches	
	Min.	Max.	Min.	Max.
A	0.900	1.150	0.035	0.045
A1	0.000	0.100	0.000	0.004
A2	0.900	1.050	0.035	0.041
b	0.300	0.500	0.012	0.020
c	0.080	0.150	0.003	0.006
D	2.800	3.000	0.110	0.118
E	1.200	1.400	0.047	0.055
E1	2.250	2.550	0.089	0.100
e	0.950 TYP		0.037 TYP	
e1	1.800	2.000	0.071	0.079
L	0.550 REF		0.022 REF	
L1	0.300	0.500	0.012	0.020
θ	0°	8°	0°	8°

SOT-23 Suggested Pad Layout

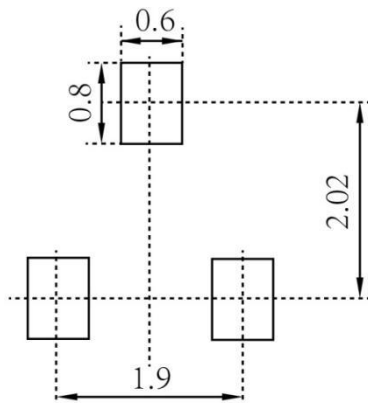

Note:

1. Controlling dimension: in millimeters
2. General tolerance: $\pm 0.05\text{mm}$
3. The pad layout is for reference purposes only

LOW VOLTAGE MOSFET (P-CHANNEL)

SOT-23 Tape and Reel

SOT-23 Embossed Carrier Tape

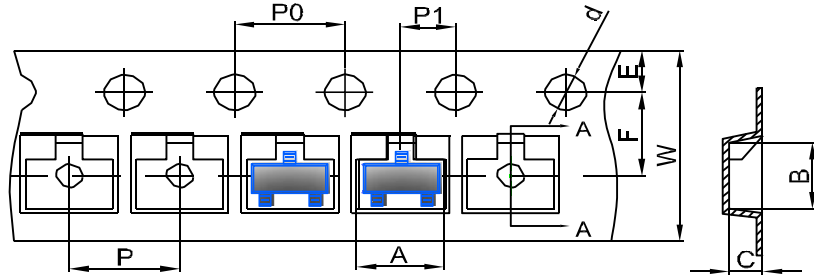

DIMENSIONS ARE IN MILLIMETER										
TYPE	A	B	C	d	E	F	P0	P	P1	W
SOT-23	3.15	2.77	1.22	Ø1.50	1.75	3.50	4.00	4.00	2.00	8.00
TOLERANCE	±0.1	±0.1	±0.1	±0.1	±0.1	±0.1	±0.1	±0.1	±0.1	±0.1

SOT-23 Tape Leader and Trailer

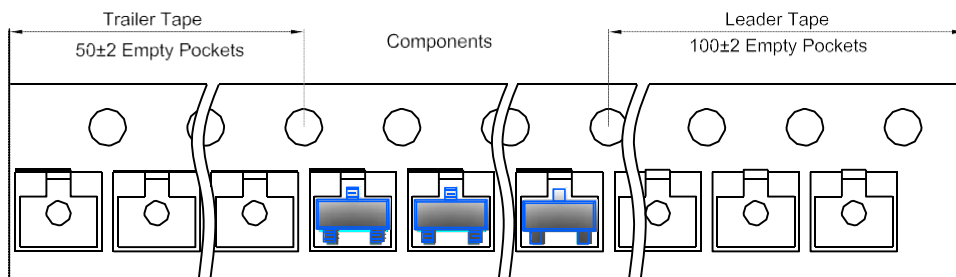

SOT-23 Reel

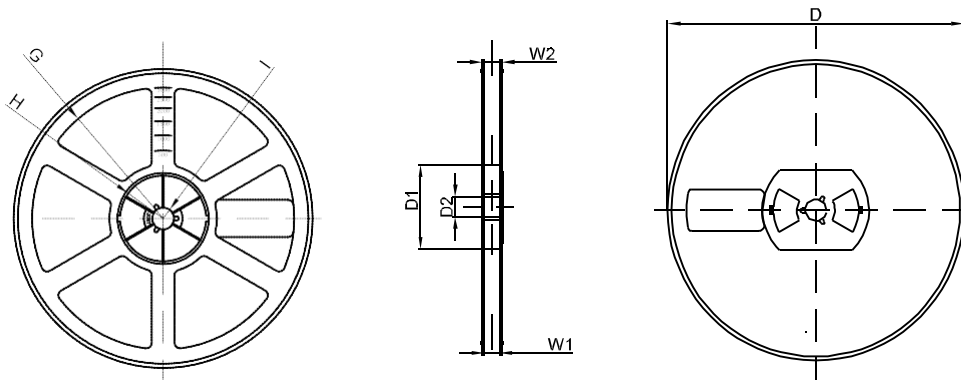

DIMENSIONS ARE IN MILLIMETER								
REEL OPTION	D	D1	D2	G	H	I	W1	W2
7" DIA	Ø178	54.40	13.00	R78	R25.60	R6.50	9.50	12.30
TOLERANCE	±2	±1	±1	±1	±1	±1	±1	±1