

Quartz Crystal Unit

Series 6C, Resistance Welded HC-49/SMD Surface Mount Package



Approved by:	
Checked by :	
Issued by:	

SPECIFICATION

MODEL: SJK-6C-12.00-20-30-50-F-B-30-H

深圳市晶科鑫实业有限公司
SHENZHEN CRYSTAL TECHNOLOGY INDUSTRIAL CO., LTD.

Add: RM#1805, East Wing, TianAn Hi-tech Plaza Phase2, TianAn Cyber Park, Shenzhen, China
Tel: (86) 755 88352809 88352810 Fax: (86) 755 88353718 88352499
E-mail: jolly@q-crystal.com HTTP://www.q-crystal.com

Quartz Crystal Unit



Series 6C, Resistance Welded HC-49/SMD Surface Mount Package

FEATURE

- I Height 4.0mm or 3.0mm, compact crystal unit to surface mount.
- I Able to by means of a metal case and completely sealed high resolution characteristics.
- I Copes with high density mounting and is the optimum for mass production.

ELECTRICAL SPECIFICATIONS

Nominal frequency	12.000MHz
Oscillation mode	Fundamental
Load capacitance	20pF
Frequency tolerance	± 30 PPM at $25 \pm 3^\circ\text{C}$
Equivalent series resistance	50Ω
Storage temperature range	-40°C --- $+85^\circ\text{C}$
Operating temperature range	-20°C --- $+70^\circ\text{C}$
Frequency Stability Over Operating Temperature	± 30 PPM
Parallel capacitance(C_0)	7PF Max
Drive level	100 μW
Insulation resistance	More than $500\text{M} \Omega$ AT DC100V

Reflow Condition

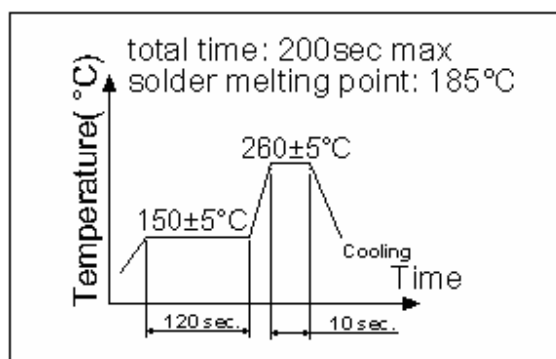

Dimension

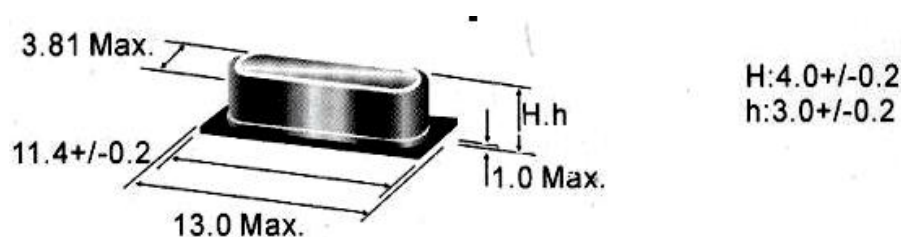

Add: RM#1805, East Wing, TianAn Hi-tech Plaza Phase2, TianAn Cyber Park, Shenzhen, China

Tel: (86) 755 88352809 88352810 Fax: (86) 755 88353718 88352499

E-mail: jolly@q-crystal.com HTTP://www.q-crystal.com

Quartz Crystal Unit

Series 6C, Resistance Welded HC-49/SMD Surface Mount Package

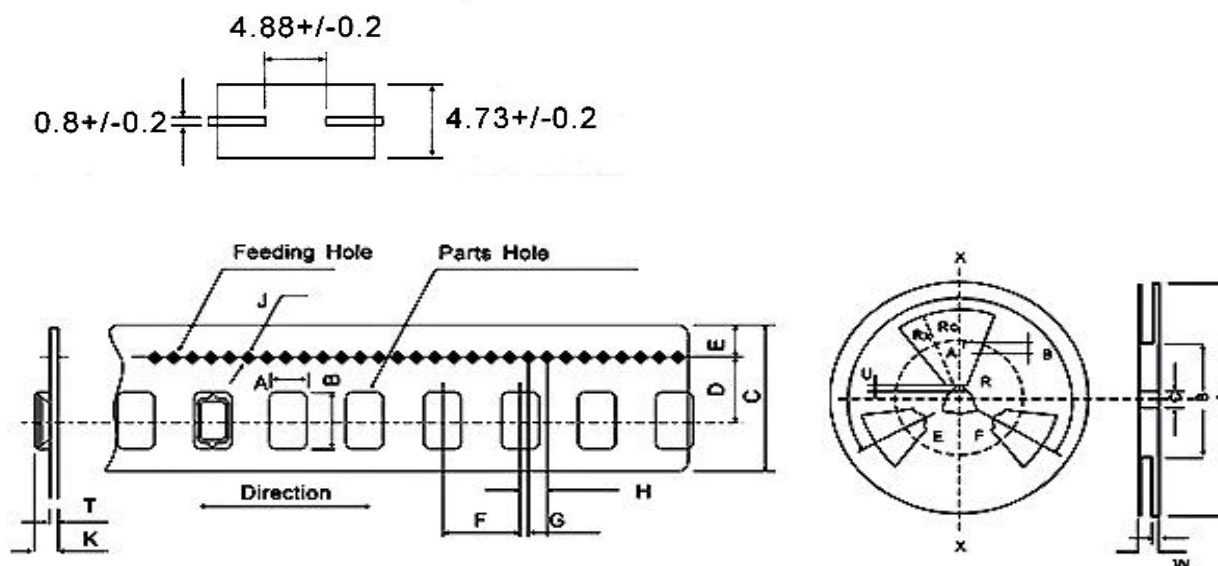

Descriptio		Code	Dimenstions	
Flanges	Diameter	A	$\phi 330 \pm 2.0$	
	Thickness	t	2.4 ± 0.2	
	Width between Flanges	W	$+2.0$ $24.4-0$	
Flanges	Outline Diameter	B	$\phi 100 \pm 2.0$	
	Center Core Slit	Width	F	2.3 ± 1.0
		Depth	V	6.0 ± 1.0
	Position	Q	$120^\circ \pm 3.0^\circ$	
	Spindle Diameter	C	$\phi 13.0 \pm 0.5$	
	Key Seats	Width	E	2.5
Depth		U	5.0 ± 0.5	
Position		Q	$120^\circ \pm 3^\circ$	
Fenestrate	Outline Radius	Ro	$R90 \pm 1.0$	
	Inline Radius	Ri	$R40 \pm 1.0$	
Rounded Comers		Rc	$+2.0$ $R5-0$	
	Open Angle	R	$40^\circ \pm 2^\circ$	

Code	Dimension	Code	Dimension	Code	Dimension
A	5.0 ± 0.1	E	1.75 ± 0.1	J	$\phi 1.5 (+0.1, -0)$
B	15.0 ± 0.2	F	$8.0 \pm 0.1 / 12.0 \pm 0.1$	K	5.0 ± 0.1
C	24.0 ± 0.3	G	2.0 ± 0.1	T	5.0 ± 0.1
D	11.05 ± 0.1	H	4.0 ± 0.1		

Add: RM#1805, East Wing, TianAn Hi-tech Plaza Phase2, TianAn Cyber Park, Shenzhen, China
 Tel: (86) 755 88352809 88352810 Fax: (86) 755 88353718 88352499
 E-mail: jolly@q-crystal.com HTTP://www.q-crystal.com

Quartz Crystal Unit



Series 6C, Resistance Welded HC-49/SMD Surface Mount Package

SJK-6C-	12.000M	20	30	50	F	B	30	H
	Frequency	Load capacitance	Frequency tolerance	E.S.R.	oscillate mode F:Fundamental 3:3rd overtone 5:5th overtone	operating temperature range A:-10-60℃ B:-20-70℃ C:-40-85℃	temperature stability:	H:Normal (4.0mm) h:low (3.0mm)

RELIABILITY TEST SPECIFICATION

Test item	Equipment	Condition	Specification
1.SOLDERABILITY TEST	SJK-REL001、RC-328A	1.solderability:245±5℃, 5±0.5S 2.heat resistance:260±5℃,10±1S restoration of 1 hour	'1. MIL-STD-883CMETHOD 2003.7 2. MIL-STD-202F,METHOD 210A
2. HERMETICITY TEST	UL-306S	small and do not control roughly (hubble-bubble machine); Nothing air bubble creation s thin leave out 1 * 10 E-8 ATM.CC/SEC.	MIL-STD-883C METHOD 1014.9
3. VIBRATION TEST	HG-V4、S&A 250B	Enable Crystal(10g) from 10-55-10Hz,X、Y、Z horizontal,1 Minute vibration/time, 1time/ 2 hours.	JIS C5025 TEST A MIL-STD-883C,METHOD 2007.2
4. MECHANICAL SHOCK	HPC-200、S&A 250B	Enable Crystal 50G(490m/s ²) time=11 ms speed=3.4 m/s half sine wave oscillation	JIS C5026 MIL-STD-883C,METHOD 2002
5. DROP TEST	HARD BOARD.S&A250B	75CM HIGH,3 TIMES ON HARD BOARD	'JIS C6701
6. SALT SPRAY	H-SST-60、RC-328A	5% NaCL,35℃±2℃ CHAMBER,48 hrs. , PH:6.5~7.2	JIS C5028 & MIL-STD-202F/METHOD 101D
7. HIGH&LOW TEMP STORAGE TEST	H-PTH-80CK & HM101-3ABN, S&A 350B/250B	High temperature: 125℃±2℃,1000hr; Low temperature:-40℃±3℃,1000hrs	MIL-STD-883C,METHOD 1011.8& JIS C5030
8.TEMP &HUM CYCLING TEST	H-PTH-80CK CHAMBER, S&A 350B/250B	Temperature:-10℃±2℃ ~ 65℃±2℃ ,Humidity:93±3%,1 cycle need 24 hrs. 5cycles.	MIL-STD-883C,METHOD 1010.7
9. HIGH TEM. & HUM. STORAGE TEST	H-PTH-80CK CHAMBER, S&A350B/250B	temperature:40℃±2℃ , Humidity:85+3,-2%,Store 96 hrs	JIS C5023
10. AGING TEST	H-PTH-80CK CHAMBER, S&A350B/250	temperature: 85℃±2, 1000hrs	JIS C5031

Add: RM#1805, East Wing,TianAn Hi-tech Plaza Phase2,TianAn Cyber Park, Shenzhen, China
 Tel: (86) 755 88352809 88352810 Fax: (86) 755 88353718 88352499
 E-mail: jolly@q-crystal.com HTTP://www.q-crystal.com