

AC FAN

80mm~280mm



NA1725



General Specification

Size: 172×172×51mm
 Airflow: 272~336m³/hr 160-198CFM
 Weight: 860g
 Noise: 49~59dBA
 Impeller: PBT Black
 Frame: Aluminum Alloy
 Terminals: 0.5mm
 Lead Wire: AWG#22
 Motor: Shaded Pole Induction Motor
 Operation Temperature: -10°C~+65°C

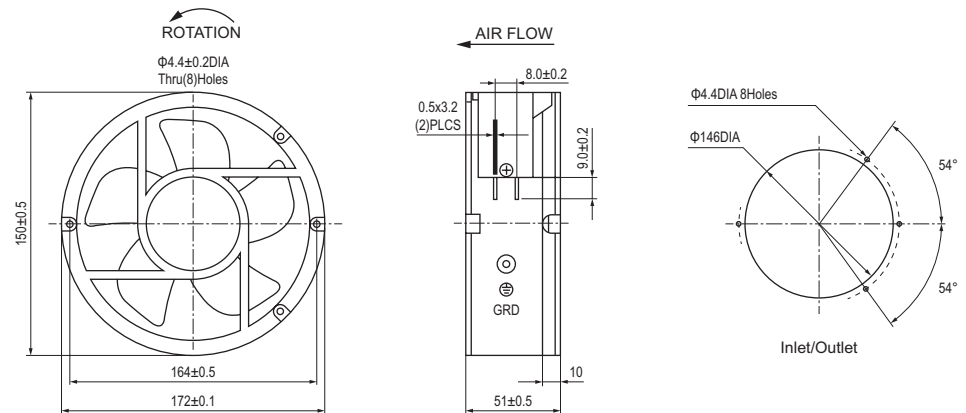

Specific Parameters

Model Number	Bearing Type	Voltage (V)	Freq. (Hz)	Current (A)	Power (W)	Speed (RPM)	Noise (dBA)	Air Flow		Phase	Capacitor
								M ³ /hr	CFM		
17251-110BH	Ball	100~125	50/60	0.45/0.40	26/28	2650/2950	54/59	299/336	176/198	1	/
17251-230BH	Ball	200~240	50/60	0.23/0.20	26/28	2650/2950	54/59	299/336	176/198	1	/
17251-380BH	Ball	380	50/60	0.13/0.11	26/28	2650/2950	54/59	299/336	176/198	1	/
17251-110SH	Sleeve	100~125	50/60	0.45/0.40	26/28	2650/2950	54/59	299/336	176/198	1	/
17251-230SH	Sleeve	200~240	50/60	0.23/0.20	26/28	2650/2950	54/59	299/336	176/198	1	/
17251-380SH	Sleeve	380	50/60	0.13/0.11	26/28	2650/2950	54/59	299/336	176/198	1	/

"B" means Ball, "S" means Sleeve, "H" means High Speed, "M" means Middle Speed, Current, Speed can be customer made

