

TINA-Y-M

~25° medium beam. Assembly with holder, installation tape and pins.

SPECIFICATION:

Dimensions	Ø 16.1 mm
Height	10 mm
Fastening	tape, pin
ROHS compliant	yes ⓘ

MATERIALS:

Component	Type	Material	Colour	Finish
TINA-Y-M	Single lens	PMMA	clear	gloss
TINA-Y-HLD	Holder	PC	black	gloss
TINA-Y-TAPE	Tape	Acrylic foam		

ORDERING INFORMATION:

Component	Qty in box	MOQ	MPQ	Box weight (kg)
CA18104_TINA-Y-M » Box size: 476 x 273 x 197 mm	3900	300	300	5.9



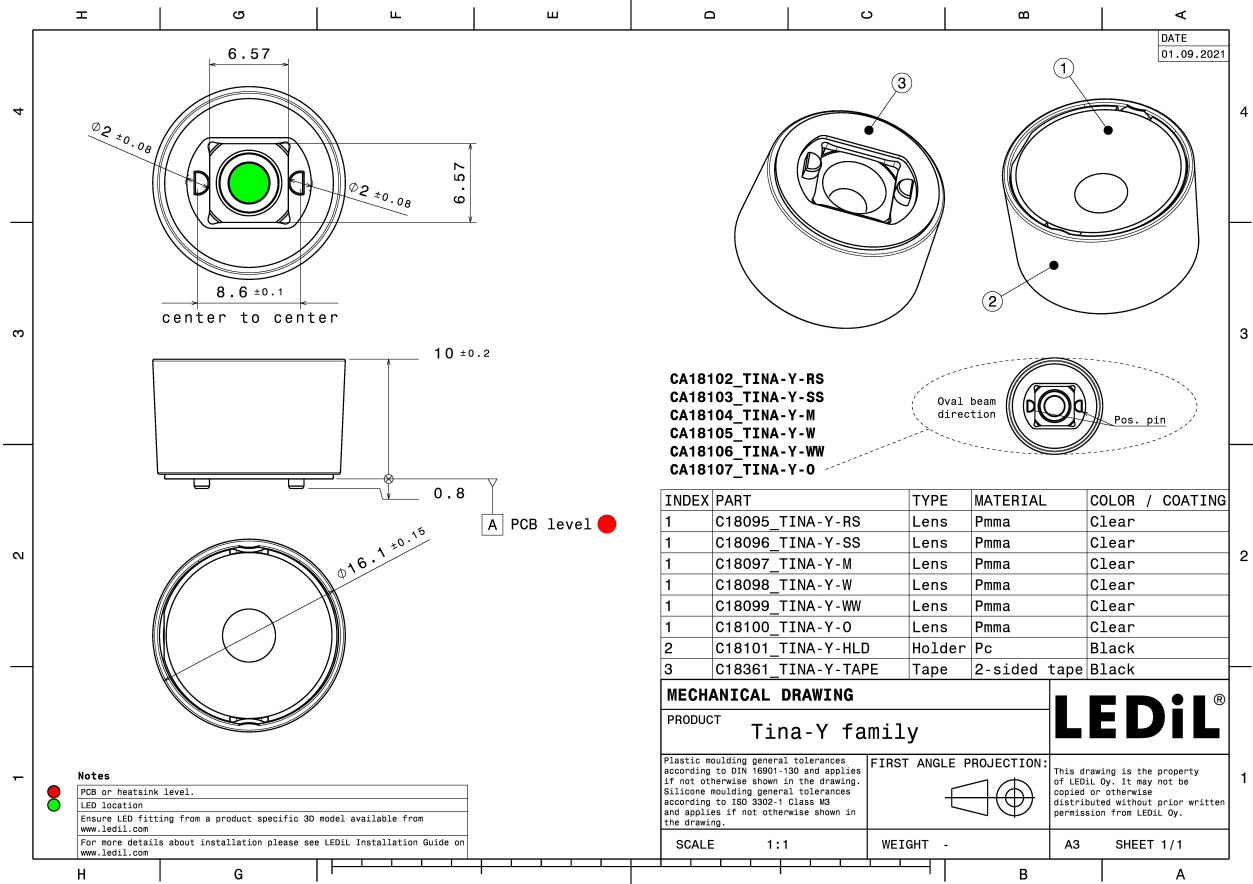

See also our general installation guide: www.ledil.com/installation_guide

OPTICAL RESULTS (MEASURED):



LED XP-G3
 FWHM / FWTM 24.0° / 47.0°
 Efficiency 77 %
 Peak intensity 3.3 cd/lm
 LEDs/each optic 1
 Light colour White
 Required components:

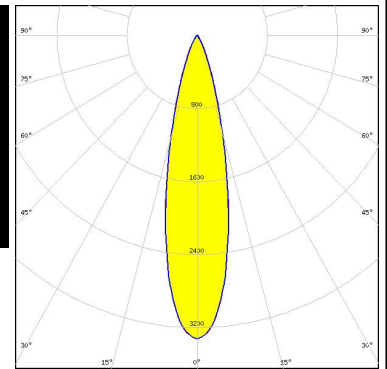
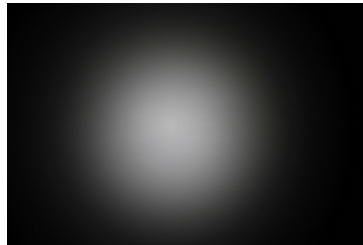

LED XP-G4
 FWHM / FWTM 23.0° / 43.0°
 Efficiency 83 %
 Peak intensity 4.1 cd/lm
 LEDs/each optic 1
 Light colour White
 Required components:

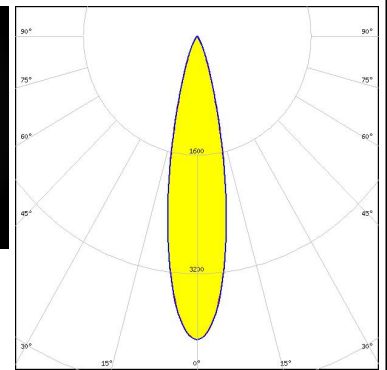

LED NVSW719AC
 FWHM / FWTM 23.0° / 43.0°
 Efficiency 84 %
 Peak intensity 4.2 cd/lm
 LEDs/each optic 1
 Light colour White
 Required components:

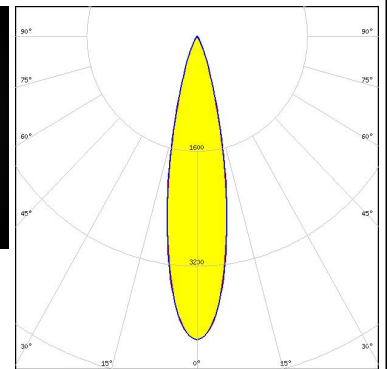
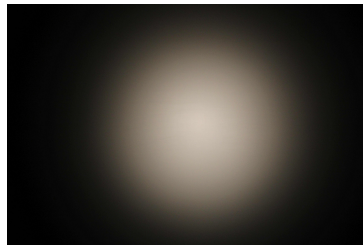

LED OSCONIQ C 3030
 FWHM / FWTM 23.0° / 44.0°
 Efficiency 80 %
 Peak intensity 4 cd/lm
 LEDs/each optic 1
 Light colour White
 Required components:

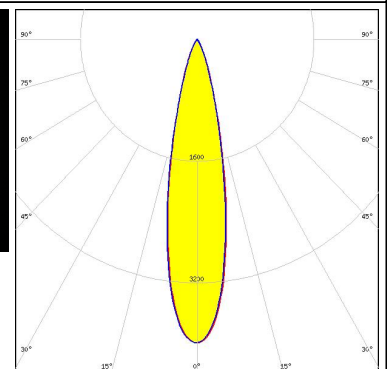
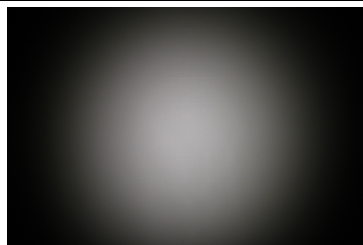

OPTICAL RESULTS (SIMULATED):



LED XHP35.2 HD
 FWHM / FWTM 32.0° / 61.0°
 Efficiency 74 %
 Peak intensity 1.9 cd/lm
 LEDs/each optic 1
 Light colour White
 Required components:

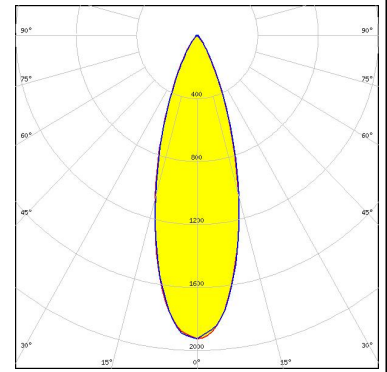

LED XHP35.2 HI
 FWHM / FWTM 26.0° / 50.0°
 Efficiency 74 %
 Peak intensity 2.8 cd/lm
 LEDs/each optic 1
 Light colour White
 Required components:

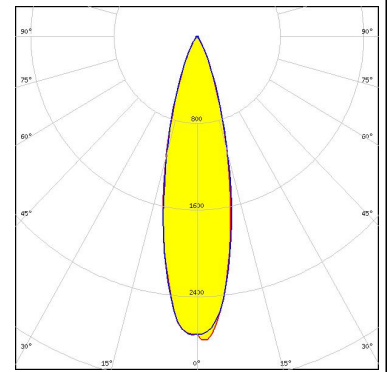

LED XM-L RGBW (XMLDCL HD)
 FWHM / FWTM 32.0° / 61.0°
 Efficiency 83 %
 Peak intensity 2.2 cd/lm
 LEDs/each optic 1
 Light colour RGBW
 Required components:

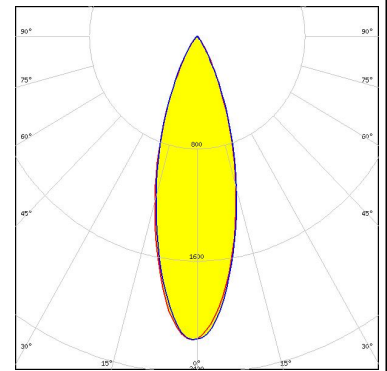

LED XM-L3
 FWHM / FWTM 30.0° / 58.0°
 Efficiency 79 %
 Peak intensity 2.4 cd/lm
 LEDs/each optic 1
 Light colour White
 Required components:

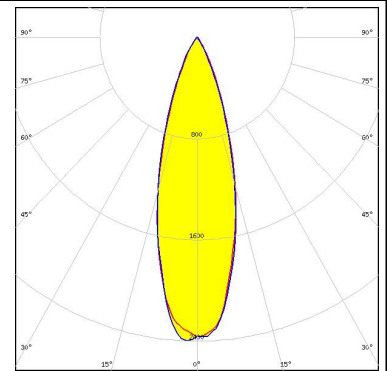

OPTICAL RESULTS (SIMULATED):

<p>CREE LEDs</p> <p>LED: XP-E FWHM / FWTM: 28.0° / 44.0° Efficiency: 88 % Peak intensity: 3.6 cd/lm LEDs/each optic: 1 Light colour: White Required components:</p>	
<p>CREE LEDs</p> <p>LED: XP-E2 FWHM / FWTM: 27.0° / 46.0° Efficiency: 89 % Peak intensity: 3.7 cd/lm LEDs/each optic: 1 Light colour: White Required components:</p>	
<p>CREE LEDs</p> <p>LED: XP-G2 FWHM / FWTM: 26.0° / 46.0° Efficiency: 87 % Peak intensity: 3.6 cd/lm LEDs/each optic: 1 Light colour: White Required components:</p>	
<p>CREE LEDs</p> <p>LED: XQ-E HI FWHM / FWTM: 26.0° / 42.0° Efficiency: 87 % Peak intensity: 3.9 cd/lm LEDs/each optic: 1 Light colour: White Required components:</p>	

OPTICAL RESULTS (SIMULATED):

<p>LUMILEDS</p> <p>LED LUXEON 5050 Round LES</p> <p>FWHM / FWTM 32.0° / 64.0°</p> <p>Efficiency 78 %</p> <p>Peak intensity 2.1 cd/lm</p> <p>LEDs/each optic 1</p> <p>Light colour White</p> <p>Required components:</p>	
<p>LUMILEDS</p> <p>LED LUXEON 5050 Round LES</p> <p>FWHM / FWTM 32.0° / 62.0°</p> <p>Efficiency 78 %</p> <p>Peak intensity 2.1 cd/lm</p> <p>LEDs/each optic 1</p> <p>Light colour White</p> <p>Required components:</p>	
<p>LUMILEDS</p> <p>LED LUXEON 5050 Square LES</p> <p>FWHM / FWTM 32.0° / 62.0°</p> <p>Efficiency 76 %</p> <p>Peak intensity 2 cd/lm</p> <p>LEDs/each optic 1</p> <p>Light colour White</p> <p>Required components:</p>	
<p>LUMILEDS</p> <p>LED LUXEON C</p> <p>FWHM / FWTM 30.0° / 47.0°</p> <p>Efficiency 78 %</p> <p>Peak intensity 3 cd/lm</p> <p>LEDs/each optic 1</p> <p>Light colour White</p> <p>Required components:</p>	

OPTICAL RESULTS (SIMULATED):

LUMILEDS

LED LUXEON HL2X
 FWHM / FWTM 29.0° / 52.0°
 Efficiency 86 %
 Peak intensity 3 cd/lm
 LEDs/each optic 1
 Light colour White
 Required components:

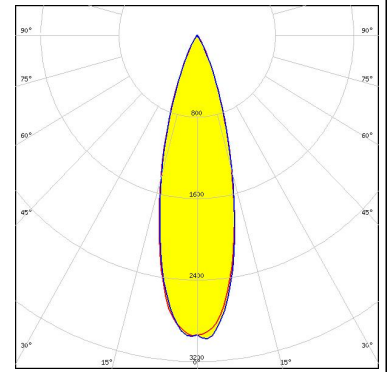

LUMILEDS

LED LUXEON MZ
 FWHM / FWTM 28.0° / 53.0°
 Efficiency 81 %
 Peak intensity 2.9 cd/lm
 LEDs/each optic 1
 Light colour White
 Required components:

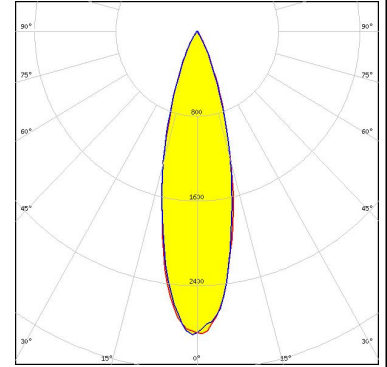

LUMILEDS

LED LUXEON TX
 FWHM / FWTM 25.0° / 46.0°
 Efficiency 84 %
 Peak intensity 3.6 cd/lm
 LEDs/each optic 1
 Light colour White
 Required components:

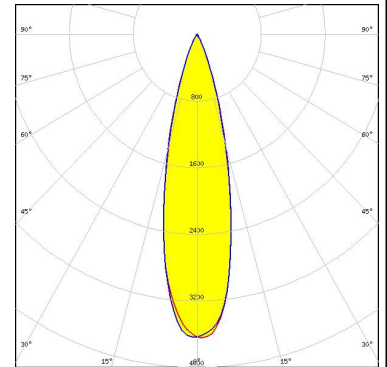

LUMINUS

LED SST-20
 FWHM / FWTM 26.0° / 44.0°
 Efficiency 85 %
 Peak intensity 3.9 cd/lm
 LEDs/each optic 1
 Light colour White
 Required components:

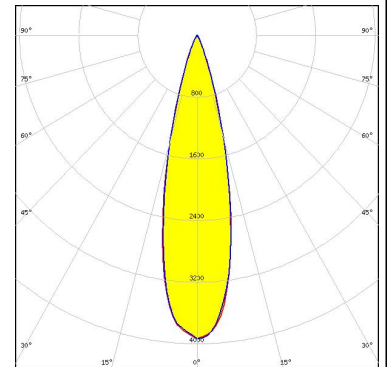

OPTICAL RESULTS (SIMULATED):

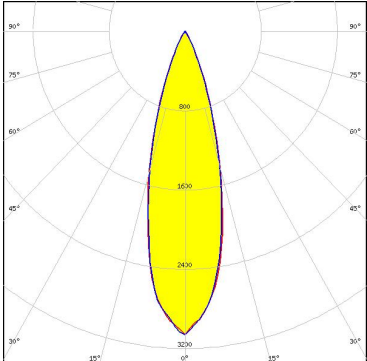
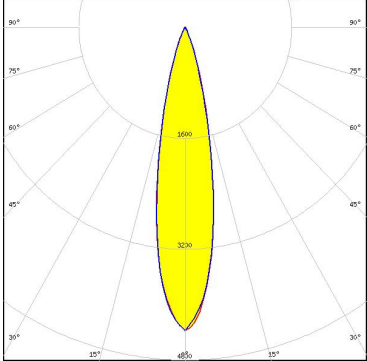
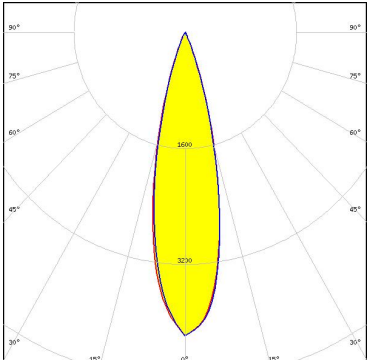
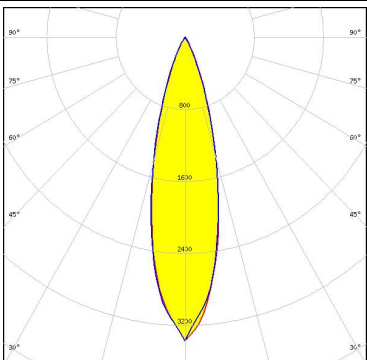
<p>NICHIA</p> <p>LED: NVSW219F FWHM / FWTM: 28.0° / 51.0° Efficiency: 86 % Peak intensity: 3 cd/lm LEDs/each optic: 1 Light colour: White Required components:</p>	
<p>NICHIA</p> <p>LED: NVSxE21A FWHM / FWTM: 22.0° / 42.0° Efficiency: 78 % Peak intensity: 4.4 cd/lm LEDs/each optic: 1 Light colour: White Required components:</p>	
<p>OSRAM <small>Opto Semiconductors</small></p> <p>LED: OSOLON Square CSSRM2/CSSRM3 FWHM / FWTM: 24.0° / 43.0° Efficiency: 87 % Peak intensity: 4.3 cd/lm LEDs/each optic: 1 Light colour: White Required components:</p>	
<p>SAMSUNG</p> <p>LED: LH351B FWHM / FWTM: 26.0° / 50.0° Efficiency: 85 % Peak intensity: 3.4 cd/lm LEDs/each optic: 1 Light colour: White Required components:</p>	

OPTICAL RESULTS (SIMULATED):

SAMSUNG

LED	LH351C
FWHM / FWTM	27.0° / 51.0°
Efficiency	86 %
Peak intensity	3.2 cd/lm
LEDs/each optic	1
Light colour	White
Required components:	

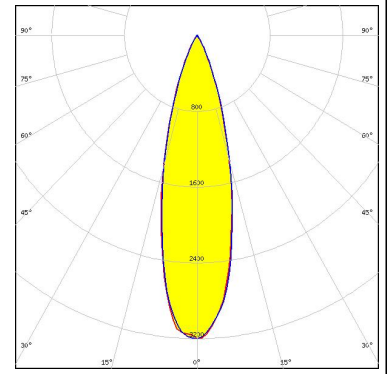

GENERAL INFORMATION:

NOTE: The typical beam angle will be changed by different color, chip size and chip position tolerance. The typical total beam angle is the full angle measured where the luminous intensity is half of the peak value.

MATERIALS:

As part of our continuous research and improvement processes, and to ensure the best possible quality and availability of our products, LEDiL reserves the right to change material grades without notice.

PRODUCT DATA USER AGREEMENT AND DISCLAIMER:

The measured data in the provided downloadable LEDiL Product Datasheets and Mechanical 2D-Drawings is rounded and provided as reference for planning. LEDiL Oy's optical specifications have been verified by conducting performance testing of the products in accordance with the company's quality system. The reported data are averaged results of multiple measurements with typical variation. LEDiL Oy reserves the right to without prior notification make changes and improvements to its products.

LEDiL Oy assumes neither warranty, nor guarantee nor any other liability of any kind for the contents and correctness of the provided data. The provided data has been generated with highest diligence but the provided data may in reality not represent the complete possible variation range of all intrinsic parameters. Therefore, in certain cases a deviation from the provided data could occur.

LEDiL Oy reserves the right to undertake technical changes of its products without further notification which could lead to changes in the provided data. LEDiL Oy assumes no liability of any kind for the possible deviation from any provided data or any other damage resulting from the usage of the provided data.

The user agrees to this disclaimer and user agreement with the download or usage of the provided files.

LEDiL Oy

Joensuunkatu 13
FI-24240 SALO
Finland

LEDiL Inc.

228 West Page Street
Suite D
Sycamore IL 60178
USA

Ledil Optics Technology (Shenzhen) Co., Ltd.

405 , Block B
Casic Motor Building
Shenzhen 518057
P.R.CHINA

Local sales and technical support

[www.ledil.com/
where_to_buy](http://www.ledil.com/where_to_buy)

Shipping locations

Salo, Finland
Hong Kong, China

Distribution Partners

[www.ledil.com/
where_to_buy](http://www.ledil.com/where_to_buy)