

General Description

These N-Channel enhancement mode power field effect transistors are using trench DMOS technology. This advanced technology has been especially tailored to minimize on-state resistance, provide superior switching performance, and withstand high energy pulse in the avalanche and commutation mode. These devices are well suited for high efficiency fast switching applications.

| | | |
|-------|-------|------|
| BVDSS | RDSON | ID |
| 100V | 2.3mΩ | 220A |

Features

- 100V,220A, $R_{DS(ON)} = 2.3m\Omega$ @ $V_{GS} = 10V$
- Improved dv/dt capability
- Fast switching
- 100% EAS Guaranteed
- Green Device Available

TO263 Pin Configuration

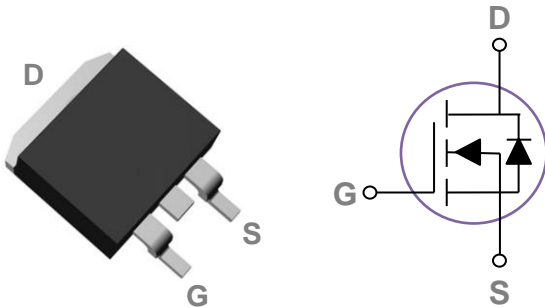

Applications

- Networking
- Load Switch
- LED applications
- Quick Charger

Absolute Maximum Ratings $T_c=25^\circ C$ unless otherwise noted

| Symbol | Parameter | Rating | Units |
|-----------|--|------------|---------------|
| V_{DS} | Drain-Source Voltage | 100 | V |
| V_{GS} | Gate-Source Voltage | ± 20 | V |
| I_D | Drain Current – Continuous ($T_c=25^\circ C$) | 220 | A |
| | Drain Current – Continuous ($T_c=100^\circ C$) | 140 | A |
| I_{DM} | Drain Current – Pulsed ¹ | 880 | A |
| EAS | Single Pulse Avalanche Energy ² | 952 | mJ |
| IAS | Single Pulse Avalanche Current ² | 138 | A |
| P_D | Power Dissipation ($T_c=25^\circ C$) | 298 | W |
| | Power Dissipation – Derate above $25^\circ C$ | 2.38 | W/ $^\circ C$ |
| T_{STG} | Storage Temperature Range | -55 to 150 | $^\circ C$ |
| T_J | Operating Junction Temperature Range | -55 to 150 | $^\circ C$ |

Thermal Characteristics

| Symbol | Parameter | Typ. | Max. | Unit |
|-----------------|--|------|------|--------------|
| $R_{\theta JA}$ | Thermal Resistance Junction to ambient | --- | 62 | $^\circ C/W$ |
| $R_{\theta JC}$ | Thermal Resistance Junction to Case | --- | 0.42 | $^\circ C/W$ |

Electrical Characteristics (T_J=25 °C, unless otherwise noted)
Off Characteristics

| Symbol | Parameter | Conditions | Min. | Typ. | Max. | Unit |
|-------------------|--------------------------------|---|------|------|------|------|
| BV _{DSS} | Drain-Source Breakdown Voltage | V _{GS} =0V, I _D =250μA | 100 | --- | --- | V |
| I _{DSS} | Drain-Source Leakage Current | V _{DS} =80V, V _{GS} =0V, T _J =25°C | --- | --- | 1 | μA |
| | | V _{DS} =80V, V _{GS} =0V, T _J =85°C | --- | --- | 10 | μA |
| I _{GSS} | Gate-Source Leakage Current | V _{GS} =±20V, V _{DS} =0V | --- | --- | ±100 | nA |

On Characteristics

| | | | | | | |
|---------------------|--|--|-----|-----|-----|----|
| R _{DS(ON)} | Static Drain-Source On-Resistance ³ | V _{GS} =10V, I _D =20A | --- | 1.9 | 2.3 | mΩ |
| V _{GS(th)} | Gate Threshold Voltage | V _{GS} =V _{DS} , I _D =250μA | 2 | 2.6 | 4 | V |
| g _{fs} | Forward Transconductance | V _{DS} =10V, I _D =3A | --- | 21 | --- | S |

Dynamic and switching Characteristics

| | | | | | | |
|---------------------|-------------------------------------|---|-----|------|-------|----|
| Q _g | Total Gate Charge ^{3, 4} | V _{DS} =50V, V _{GS} =10V, I _D =80A | --- | 122 | 185 | nC |
| Q _{gs} | Gate-Source Charge ^{3, 4} | | --- | 27 | 40 | |
| Q _{gd} | Gate-Drain Charge ^{3, 4} | | --- | 33 | 50 | |
| T _{d(on)} | Turn-On Delay Time ^{3, 4} | V _{DD} =50V, V _{GS} =10V, R _G =6Ω I _D =80A | --- | 20 | 30 | ns |
| T _r | Rise Time ^{3, 4} | | --- | 32 | 50 | |
| T _{d(off)} | Turn-Off Delay Time ^{3, 4} | | --- | 98 | 150 | |
| T _f | Fall Time ^{3, 4} | | --- | 32 | 50 | |
| C _{iss} | Input Capacitance | V _{DS} =50V, V _{GS} =0V, F=1MHz | --- | 7700 | 11550 | pF |
| C _{oss} | Output Capacitance | | --- | 1500 | 2250 | |
| C _{rss} | Reverse Transfer Capacitance | | --- | 30 | 45 | |
| R _g | Gate resistance | V _{GS} =0V, V _{DS} =0V, F=1MHz | --- | 1 | --- | Ω |

Drain-Source Diode Characteristics and Maximum Ratings

| Symbol | Parameter | Conditions | Min. | Typ. | Max. | Unit |
|-----------------|---------------------------|---|------|------|------|------|
| I _S | Continuous Source Current | V _G =V _D =0V, Force Current | --- | --- | 220 | A |
| I _{SM} | Pulsed Source Current | | --- | --- | 440 | A |
| V _{SD} | Diode Forward Voltage | V _{GS} =0V, I _S =1A, T _J =25°C | --- | --- | 1 | V |
| t _{rr} | Reverse Recovery Time | V _R =100V, I _S =10A | --- | 250 | --- | ns |
| Q _{rr} | Reverse Recovery Charge | di/dt=100A/μs, T _J =25°C | --- | 820 | --- | nC |

Note :

1. Repetitive Rating : Pulsed width limited by maximum junction temperature.
2. V_{DD}=50V, V_{GS}=10V, L=0.1mH, I_{AS}=138A., R_G=25Ω, Starting T_J=25°C.
3. The data tested by pulsed, pulse width ≤ 300us, duty cycle ≤ 2%.
4. Essentially independent of operating temperature.

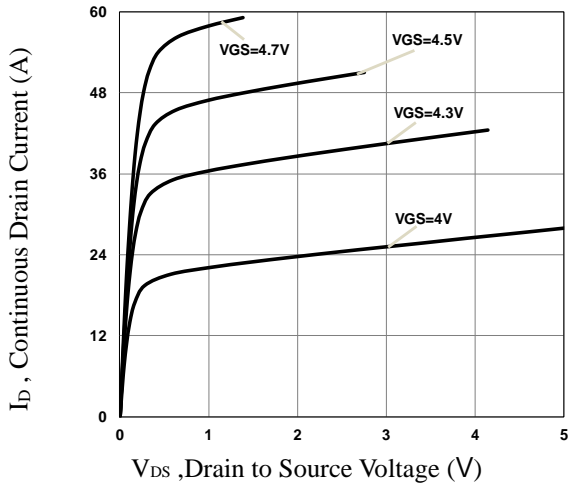

Fig.1 Typical Output Characteristics

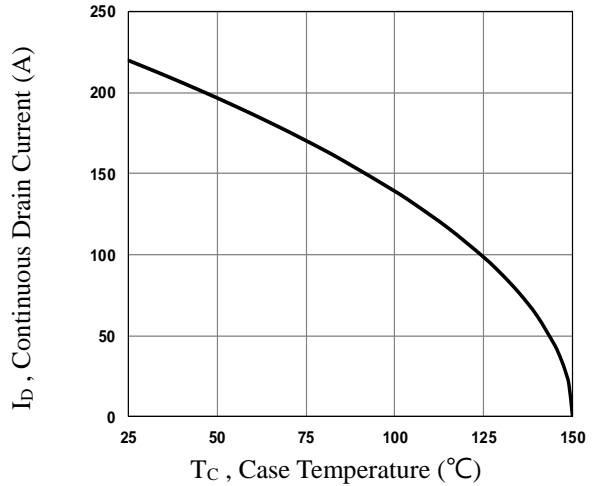

Fig.2 Continuous Drain Current vs. T_c

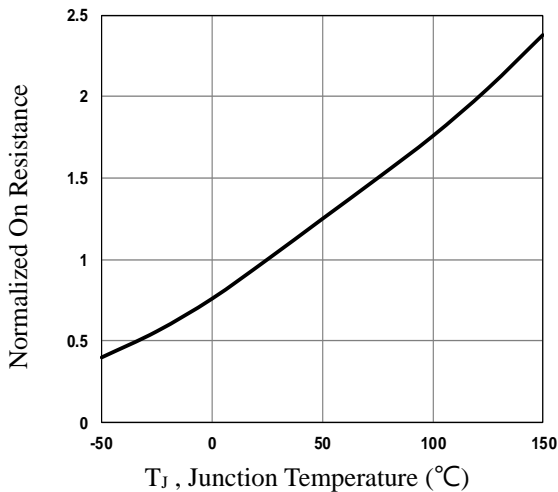

Fig.3 Normalized R_{DS(on)} vs. T_j

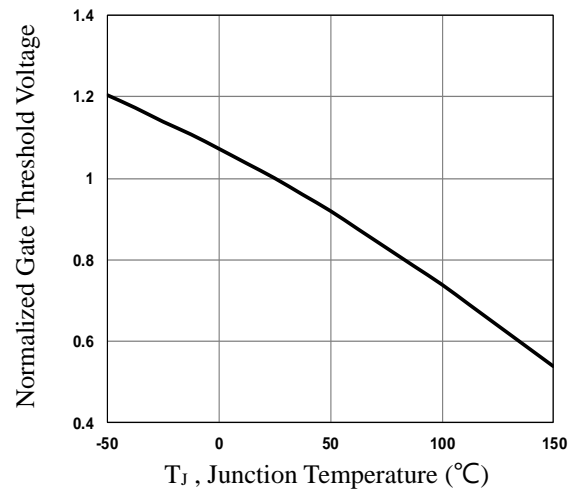

Fig.4 Normalized V_{th} vs. T_j

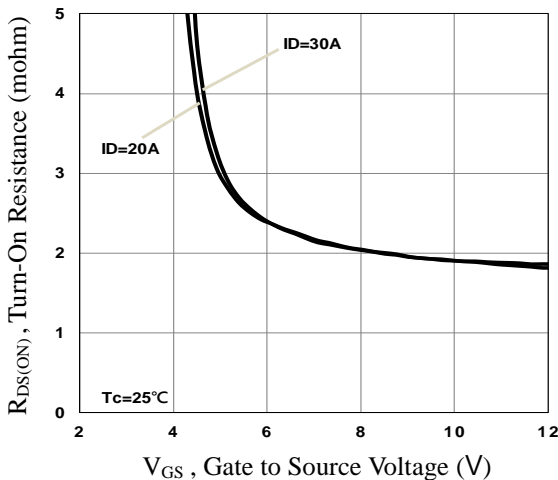

Fig.5 Turn-On Resistance vs. V_{GS}

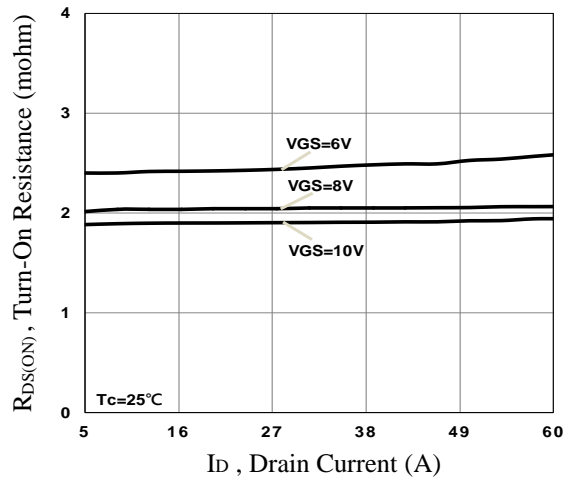

Fig.6 Turn-On Resistance vs. I_D

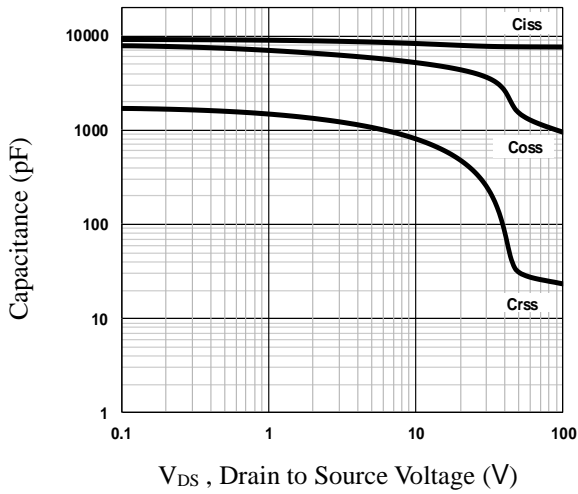

Fig.7 Capacitance Characteristics

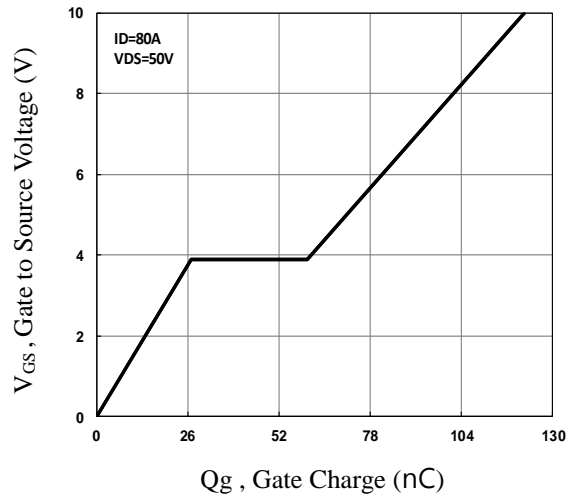

Fig.8 Gate Charge Characteristics

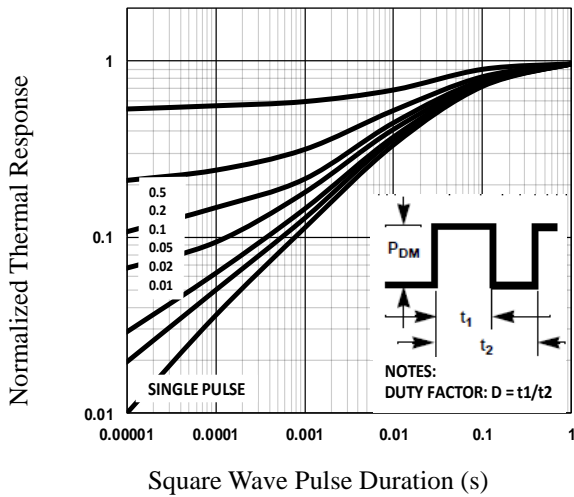

Fig.9 Normalized Transient Impedance

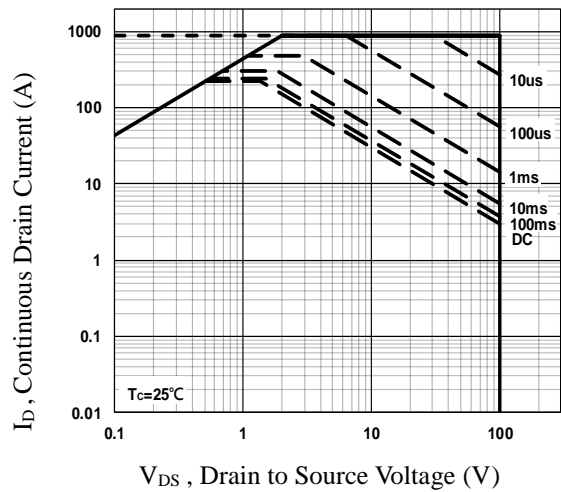

Fig.10 Maximum Safe Operation Area

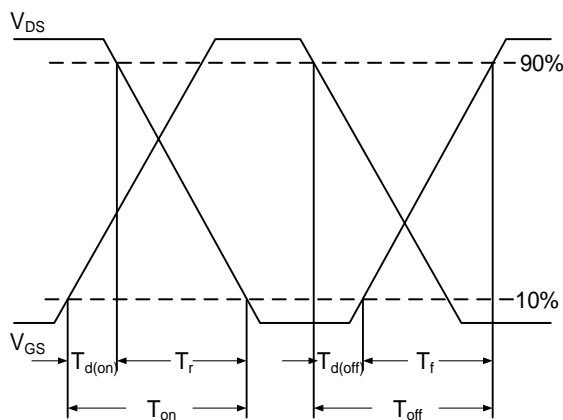

Fig.11 Switching Time Waveform

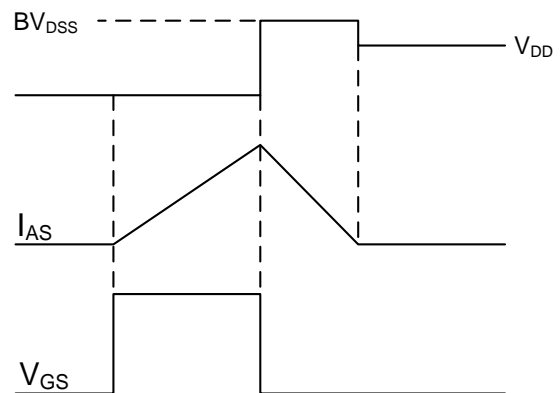
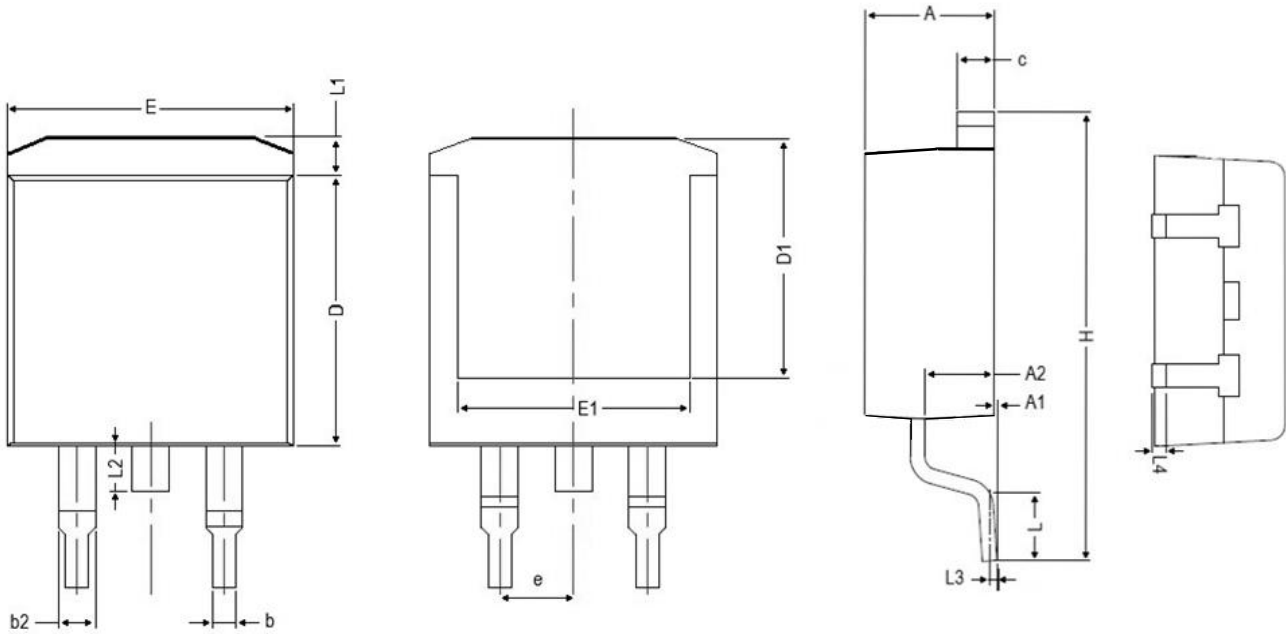

Fig.12 EAS Waveform

TO263 PACKAGE INFORMATION



| Symbol | Dimensions In Millimeters | | Dimensions In Inches | |
|--------|---------------------------|--------|----------------------|-------|
| | MAX | MIN | MAX | MIN |
| A | 4.850 | 4.200 | 0.191 | 0.165 |
| A1 | 0.300 | 0.000 | 0.012 | 0.000 |
| A2 | 2.900 | 2.200 | 0.114 | 0.087 |
| b | 0.950 | 0.700 | 0.037 | 0.028 |
| b2 | 1.700 | 1.000 | 0.067 | 0.039 |
| c | 1.450 | 1.150 | 0.057 | 0.045 |
| D | 9.500 | 8.350 | 0.374 | 0.329 |
| D1 | 9.150 | 6.400 | 0.360 | 0.252 |
| E | 10.500 | 9.600 | 0.413 | 0.378 |
| E1 | 8.900 | 6.850 | 0.350 | 0.270 |
| e | 2.540 BSC | | 0.100 BSC | |
| H | 15.900 | 14.600 | 0.626 | 0.575 |
| L | 2.800 | 1.700 | 0.110 | 0.067 |
| L1 | 1.700 | 1.050 | 0.067 | 0.041 |
| L2 | 2.100 | 1.300 | 0.083 | 0.051 |
| L3 | 0.250 BSC | | 0.010 BSC | |
| L4 | 0.750 | 0.200 | 0.030 | 0.008 |