

General Description

These N+P dual Channel enhancement mode power field effect transistors are using trench DMOS technology. This advanced technology has been especially tailored to minimize on-state resistance, provide superior switching performance, and withstand high energy pulse in the avalanche and commutation mode. These devices are well suited for high efficiency fast switching applications.

BVDSS	RDSON	ID
30V	12mΩ	16A
-30V	30mΩ	-12A

TO252-4L Pin Configuration

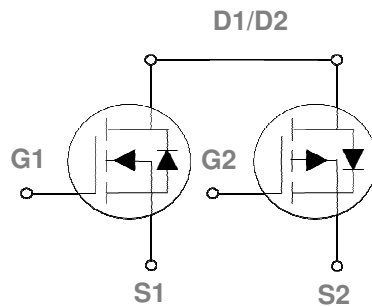
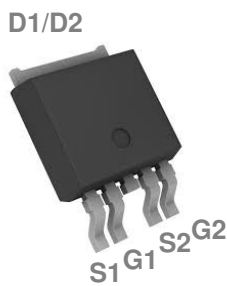

Features

- Fast switching
- Green Device Available
- Suit for 4.5V Gate Drive Applications

Applications

- DC Fan
- Motor Drive Applications
- Networking
- Half / Full Bridge Topology

Absolute Maximum Ratings $T_c=25^\circ\text{C}$ unless otherwise noted

Symbol	Parameter	Rating		Units
V_{DS}	Drain-Source Voltage	30	-30	V
V_{GS}	Gate-Source Voltage	± 20	± 20	V
I_D	Drain Current – Continuous ($T_c=25^\circ\text{C}$)	16	-12	A
	Drain Current – Continuous ($T_c=100^\circ\text{C}$)	10.1	-7.6	A
I_{DM}	Drain Current – Pulsed ¹	64	-48	A
P_D	Power Dissipation ($T_c=25^\circ\text{C}$)	32.5		W
	Power Dissipation – Derate above 25°C	0.26		W/ $^\circ\text{C}$
T_{STG}	Storage Temperature Range	-55 to 150		$^\circ\text{C}$
T_J	Operating Junction Temperature Range	-55 to 150		$^\circ\text{C}$

Thermal Characteristics

Symbol	Parameter	Typ.	Max.	Unit
$R_{\theta JA}$	Thermal Resistance Junction to ambient	---	62.5	$^\circ\text{C}/\text{W}$
$R_{\theta JC}$	Thermal Resistance Junction to Case	---	3.84	$^\circ\text{C}/\text{W}$

N-CH Electrical Characteristics ($T_J=25\text{ }^\circ\text{C}$, unless otherwise) noted)
Off Characteristics

Symbol	Parameter	Conditions	Min.	Typ.	Max.	Unit
BV_{DSS}	Drain-Source Breakdown Voltage	$V_{GS}=0V, I_D=250\mu A$	30	---	---	V
I_{DSS}	Drain-Source Leakage Current	$V_{DS}=30V, V_{GS}=0V, T_J=25^\circ C$	---	---	1	μA
		$V_{DS}=24V, V_{GS}=0V, T_J=125^\circ C$	---	---	10	μA
I_{GSS}	Gate-Source Leakage Current	$V_{GS}=\pm 20V, V_{DS}=0V$	---	---	± 100	nA

On Characteristics

$R_{DS(ON)}$	Static Drain-Source On-Resistance	$V_{GS}=10V, I_D=10A$	---	9.4	12	m Ω
		$V_{GS}=4.5V, I_D=5A$	---	13	18	m Ω
$V_{GS(th)}$	Gate Threshold Voltage	$V_{GS}=V_{DS}, I_D=250\mu A$	1.2	1.6	2.5	V
$\Delta V_{GS(th)}$	$V_{GS(th)}$ Temperature Coefficient		---	-4	---	mV/ $^\circ C$
gfs	Forward Transconductance	$V_{DS}=10V, I_D=3A$	---	6	---	S

Dynamic and switching Characteristics

Q_g	Total Gate Charge ^{3, 4}	$V_{DS}=15V, V_{GS}=4.5V, I_D=5A$	---	7.4	12	nC
Q_{gs}	Gate-Source Charge ^{3, 4}		---	2.3	5	
Q_{gd}	Gate-Drain Charge ^{3, 4}		---	3	6	
$T_{d(on)}$	Turn-On Delay Time ^{3, 4}	$V_{DD}=15V, V_{GS}=10V, R_G=6\Omega$ $I_D=1A$	---	3.8	7	ns
T_r	Rise Time ^{3, 4}		---	10	19	
$T_{d(off)}$	Turn-Off Delay Time ^{3, 4}		---	22	42	
T_f	Fall Time ^{3, 4}		---	6.6	13	
C_{iss}	Input Capacitance	$V_{DS}=25V, V_{GS}=0V, F=1MHz$	---	620	900	pF
C_{oss}	Output Capacitance		---	85	125	
C_{rss}	Reverse Transfer Capacitance		---	60	90	
R_g	Gate resistance	$V_{GS}=0V, V_{DS}=0V, f=1MHz$	---	2.8	5.6	Ω

Drain-Source Diode Characteristics and Maximum Ratings

Symbol	Parameter	Conditions	Min.	Typ.	Max.	Unit
I_S	Continuous Source Current	$V_G=V_D=0V, \text{ Force Current}$	---	---	16	A
I_{SM}	Pulsed Source Current		---	---	32	A
V_{SD}	Diode Forward Voltage	$V_{GS}=0V, I_S=1A, T_J=25^\circ C$	---	---	1	V

Note :

1. Repetitive Rating : Pulsed width limited by maximum junction temperature.
2. The data tested by pulsed , pulse width $\leq 300\mu s$, duty cycle $\leq 2\%$.
3. Essentially independent of operating temperature.

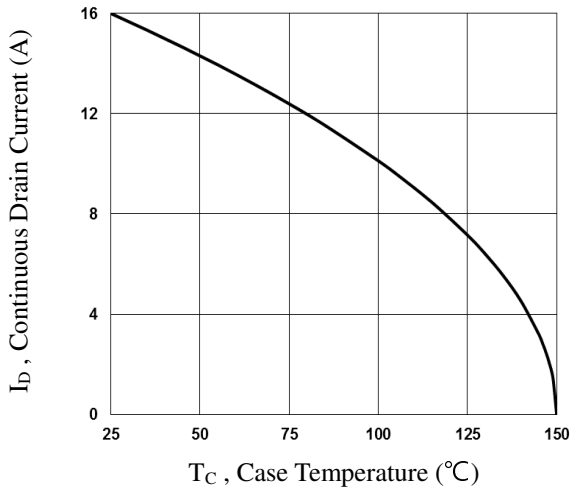

Fig.1 Continuous Drain Current vs. T_c

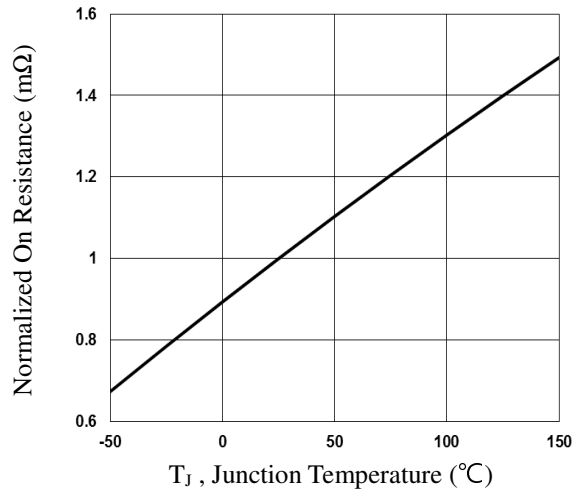

Fig.2 Normalized $R_{DS(on)}$ vs. T_j

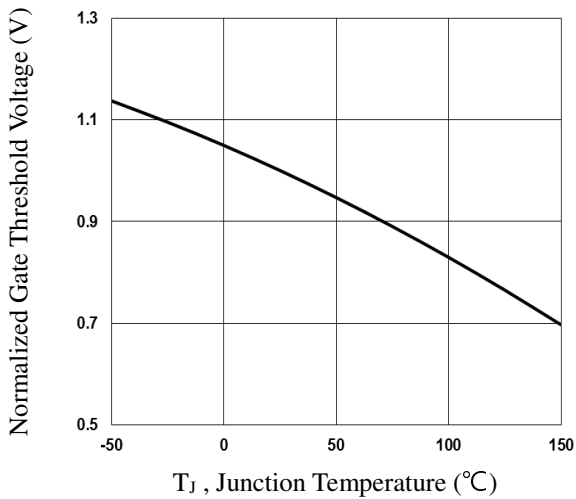

Fig.3 Normalized V_{th} vs. T_j

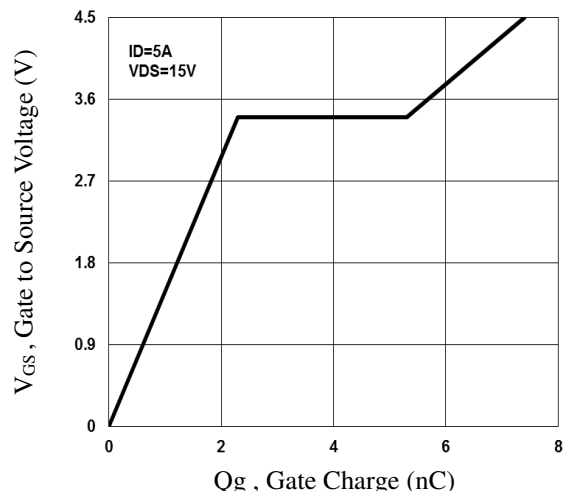

Fig.4 Gate Charge Waveform

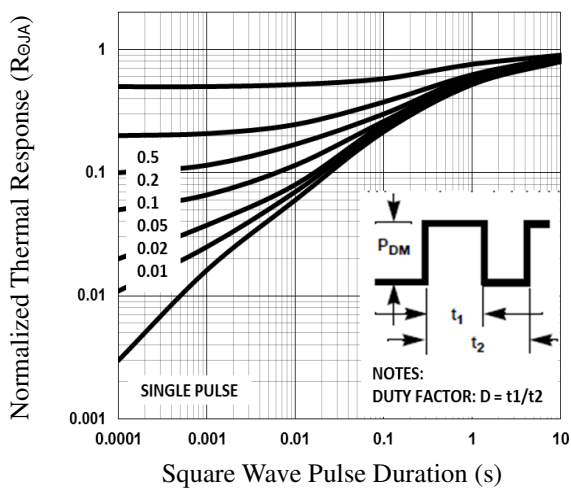

Fig.5 Normalized Transient Response

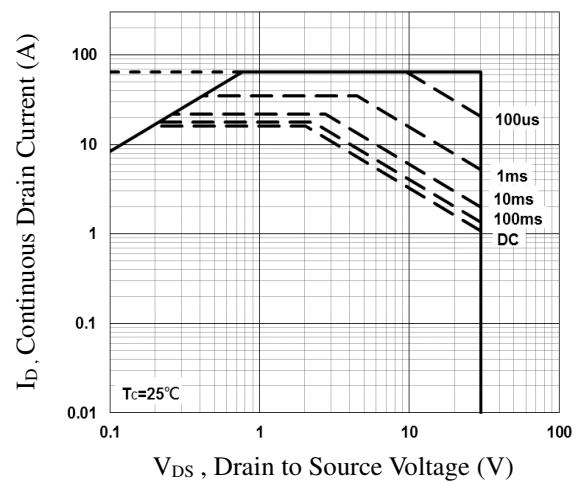

Fig.6 Maximum Safe Operation Area

P-CH Electrical Characteristics (T_J=25 °C, unless otherwise noted)
Off Characteristics

Symbol	Parameter	Conditions	Min.	Typ.	Max.	Unit
BV _{DSS}	Drain-Source Breakdown Voltage	V _{GS} =0V , I _D =-250uA	-30	---	---	V
ΔBV _{DSS} /ΔT _J	BV _{DSS} Temperature Coefficient	Reference to 25°C , I _D =-1mA	---	-0.03	---	V/°C
I _{DSS}	Drain-Source Leakage Current	V _{DS} =-30V , V _{GS} =0V , T _J =25°C	---	---	-1	uA
		V _{DS} =-24V , V _{GS} =0V , T _J =125°C	---	---	-10	uA
I _{GSS}	Gate-Source Leakage Current	V _{GS} =±20V , V _{DS} =0V	---	---	±100	nA

On Characteristics

R _{DS(ON)}	Static Drain-Source On-Resistance	V _{GS} =-10V , I _D =-7A	---	24	30	mΩ
		V _{GS} =-4.5V , I _D =-4A	---	37	46	mΩ
V _{GS(th)}	Gate Threshold Voltage	V _{GS} =V _{DS} , I _D =-250uA	-1	-1.6	-2.5	V
ΔV _{GS(th)}	V _{GS(th)} Temperature Coefficient		---	4	---	mV/°C
g _{fs}	Forward Transconductance	V _{DS} =-10V , I _D =-3A	---	9	---	S

Dynamic and switching Characteristics

Q _g	Total Gate Charge ^{2, 3}	V _{DS} =-15V , V _{GS} =-4.5V , I _D =-5A	---	8	15	nC
Q _{gs}	Gate-Source Charge ^{2, 3}		---	3.3	6	
Q _{gd}	Gate-Drain Charge ^{2, 3}		---	2.3	5	
T _{d(on)}	Turn-On Delay Time ^{2, 3}	V _{DD} =-15V , V _{GS} =-10V , R _G =6Ω I _D =-1A	---	4.6	9	ns
T _r	Rise Time ^{2, 3}		---	14	26	
T _{d(off)}	Turn-Off Delay Time ^{2, 3}		---	34	58	
T _f	Fall Time ^{2, 3}		---	18	35	
C _{iss}	Input Capacitance	V _{DS} =-15V , V _{GS} =0V , F=1MHz	---	757	1280	pF
C _{oss}	Output Capacitance		---	122	210	
C _{rss}	Reverse Transfer Capacitance		---	88	175	

Drain-Source Diode Characteristics and Maximum Ratings

Symbol	Parameter	Conditions	Min.	Typ.	Max.	Unit
I _S	Continuous Source Current	V _G =V _D =0V , Force Current	---	---	-12	A
I _{SM}	Pulsed Source Current		---	---	-24	A
V _{SD}	Diode Forward Voltage	V _{GS} =0V , I _S =-1A , T _J =25°C	---	---	-1	V

Note :

4. Repetitive Rating : Pulsed width limited by maximum junction temperature.
5. The data tested by pulsed , pulse width ≤ 300us , duty cycle ≤ 2%.
6. Essentially independent of operating temperature.

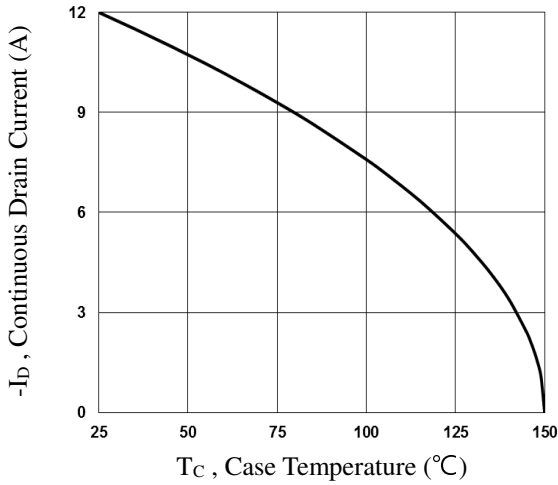

Fig.1 Continuous Drain Current vs. T_c

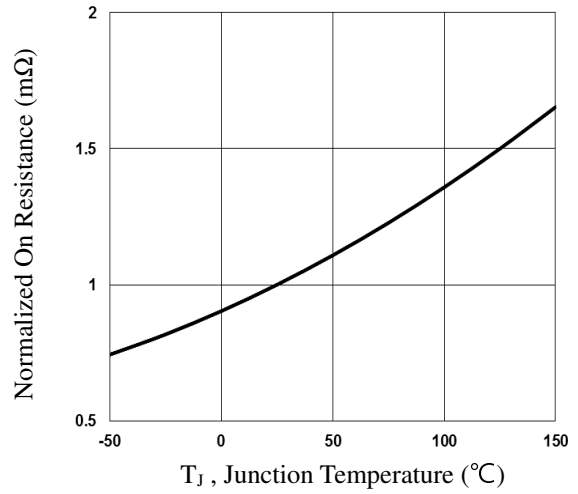

Fig.2 Normalized R_{DSon} vs. T_j

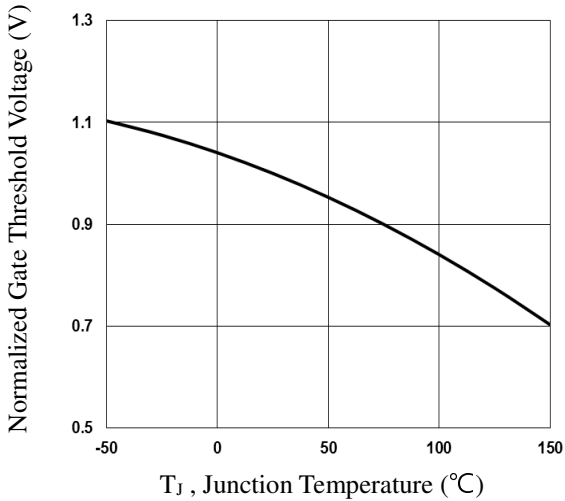

Fig.3 Normalized V_{th} vs. T_j

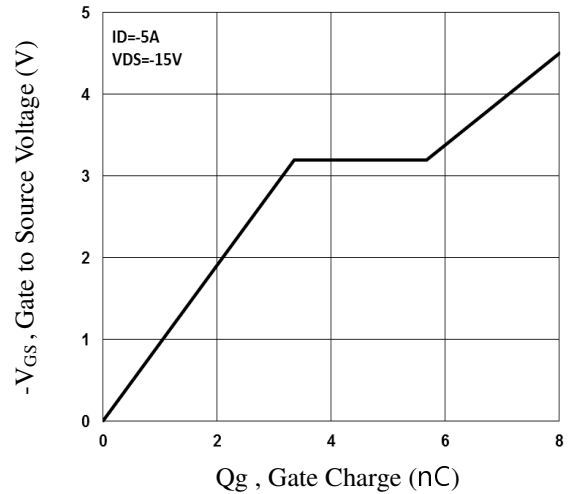

Fig.4 Gate Charge Waveform

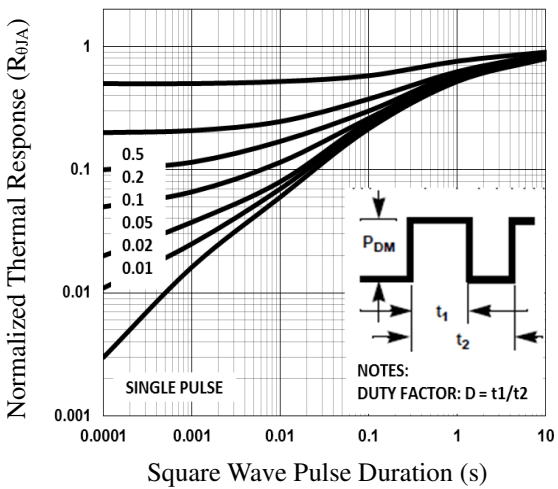

Fig.5 Normalized Transient Impedance

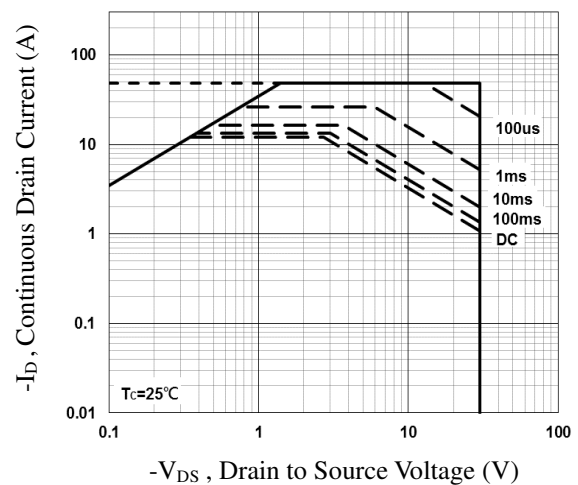
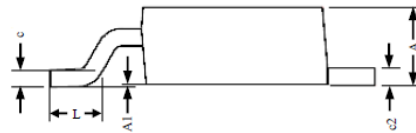
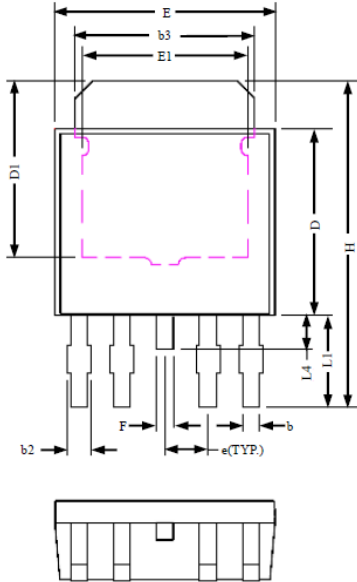

Fig.6 Maximum Safe Operation Area

TO252-4L PACKAGE INFORMATION



Symbol	Dimensions In Millimeters		Dimensions In Inches	
	MAX	MIN	MAX	MIN
A	2.400	2.200	0.094	0.087
A1	0.150	0.000	0.006	0.000
B	0.600	0.400	0.024	0.016
b2	0.800	0.500	0.031	0.020
b3	5.500	5.200	0.217	0.205
C	0.508typ.		0.02typ.	
c2	0.550	0.450	0.022	0.018
D	5.800	5.400	0.228	0.213
D1	---	4.570	---	0.180
E	6.800	6.400	0.268	0.252
E1	---	3.810	---	0.150
E	1.27ref.		0.05ref.	
F	0.600	0.400	0.024	0.016
H	10.200	9.400	0.402	0.370
L	1.770	1.400	0.070	0.055
L1	3.000	2.400	0.118	0.094
L4	1.200	0.800	0.047	0.031