

### General Description

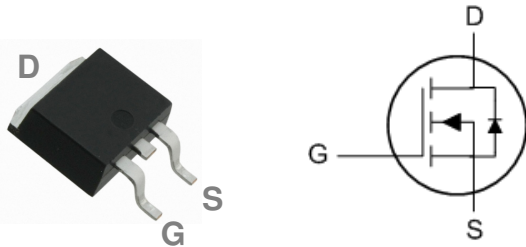
These N-Channel enhancement mode power field effect transistors are planar stripe, DMOS technology. This advanced technology has been especially tailored to minimize on-state resistance, provide superior switching performance, and withstand high energy pulse in the avalanche and commutation mode. These devices are well suited for high efficiency switch mode power supply

BVDSS	RDSON	ID
700V	2.8Ω	4A

### Features

- Improved dv/dt capability
- Fast switching
- 100% EAS Guaranteed
- Green Device Available

### TO252 Pin Configuration



### Applications

- High efficient switched mode power supplies
- TV Power
- Adapter/charger
- LED Lighting

### Absolute Maximum Ratings $T_c=25^\circ\text{C}$ unless otherwise noted

Symbol	Parameter	Rating	Units
$V_{DS}$	Drain-Source Voltage	700	V
$V_{GS}$	Gate-Source Voltage	$\pm 30$	V
$I_D$	Drain Current – Continuous ( $T_c=25^\circ\text{C}$ )	4	A
	Drain Current – Continuous ( $T_c=100^\circ\text{C}$ )	2.5	A
$I_{DM}$	Drain Current – Pulsed <sup>1</sup>	16	A
EAS	Single Pulse Avalanche Energy <sup>2</sup>	7.6	mJ
IAS	Single Pulse Avalanche Current <sup>2</sup>	3.9	A
$P_D$	Power Dissipation ( $T_c=25^\circ\text{C}$ )	42	W
	Power Dissipation – Derate above $25^\circ\text{C}$	0.345	W/ $^\circ\text{C}$
$T_{STG}$	Storage Temperature Range	-55 to 150	$^\circ\text{C}$
$T_J$	Operating Junction Temperature Range	-55 to 150	$^\circ\text{C}$

### Thermal Characteristics

Symbol	Parameter	Typ.	Max.	Unit
$R_{\theta JA}$	Thermal Resistance Junction to ambient	---	62	$^\circ\text{C}/\text{W}$
$R_{\theta JC}$	Thermal Resistance Junction to Case	---	2.93	$^\circ\text{C}/\text{W}$

**Electrical Characteristics (T<sub>J</sub>=25 °C, unless otherwise noted)**
**Off Characteristics**

Symbol	Parameter	Conditions	Min.	Typ.	Max.	Unit
BV <sub>DSS</sub>	Drain-Source Breakdown Voltage	V <sub>GS</sub> =0V , I <sub>D</sub> =250μA	700	---	---	V
I <sub>DSS</sub>	Drain-Source Leakage Current	V <sub>DS</sub> =700V , V <sub>GS</sub> =0V , T <sub>J</sub> =25°C	---	---	1	μA
		V <sub>DS</sub> =560V , V <sub>GS</sub> =0V , T <sub>J</sub> =100°C	---	---	10	μA
I <sub>GSS</sub>	Gate-Source Leakage Current	V <sub>GS</sub> =±30V , V <sub>DS</sub> =0V	---	---	±100	nA

**On Characteristics**

R <sub>DS(ON)</sub>	Static Drain-Source On-Resistance	V <sub>GS</sub> =10V , I <sub>D</sub> =1A	---	2.3	2.8	Ω
V <sub>GS(th)</sub>	Gate Threshold Voltage	V <sub>GS</sub> =V <sub>DS</sub> , I <sub>D</sub> =250μA	2	2.8	4	V
g <sub>fs</sub>	Forward Transconductance	V <sub>DS</sub> =30V , I <sub>D</sub> =2A	---	4	---	S

**Dynamic and switching Characteristics**

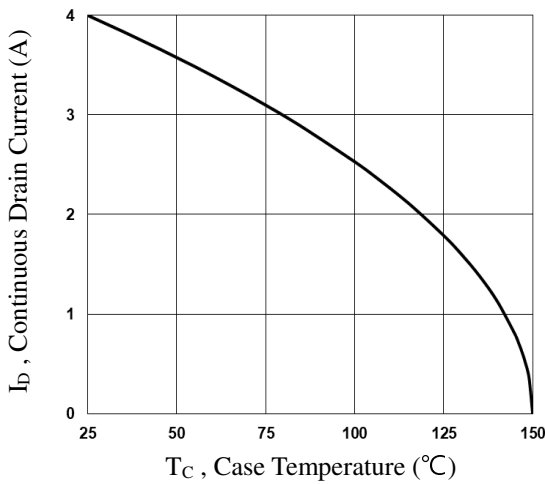
Q <sub>g</sub>	Total Gate Charge <sup>3,4</sup>	V <sub>DS</sub> =520V , V <sub>GS</sub> =10V , I <sub>D</sub> =4A	---	15.4	---	nC
Q <sub>gs</sub>	Gate-Source Charge <sup>3,4</sup>		---	2	---	
Q <sub>gd</sub>	Gate-Drain Charge <sup>3,4</sup>		---	7.3	---	
T <sub>d(on)</sub>	Turn-On Delay Time <sup>3,4</sup>	V <sub>DD</sub> =350V , V <sub>GS</sub> =10V , R <sub>G</sub> =25Ω I <sub>D</sub> =4A	---	15.4	---	ns
T <sub>r</sub>	Rise Time <sup>3,4</sup>		---	14.8	---	
T <sub>d(off)</sub>	Turn-Off Delay Time <sup>3,4</sup>		---	43.7	---	
T <sub>f</sub>	Fall Time <sup>3,4</sup>		---	10.5	---	
C <sub>iss</sub>	Input Capacitance	V <sub>DS</sub> =100V , V <sub>GS</sub> =0V , F=1MHz	---	650	---	pF
C <sub>oss</sub>	Output Capacitance		---	46	---	
C <sub>rss</sub>	Reverse Transfer Capacitance		---	7	---	

**Drain-Source Diode Characteristics and Maximum Ratings**

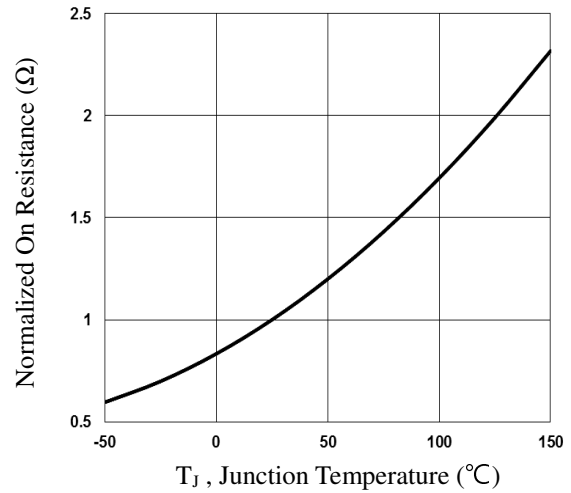
Symbol	Parameter	Conditions	Min.	Typ.	Max.	Unit
I <sub>S</sub>	Continuous Source Current	V <sub>G</sub> =V <sub>D</sub> =0V , Force Current	---	---	4	A
I <sub>SM</sub>	Pulsed Source Current		---	---	8	A
V <sub>SD</sub>	Diode Forward Voltage	V <sub>GS</sub> =0V , I <sub>S</sub> =1A , T <sub>J</sub> =25°C	---	---	1	V
t <sub>rr</sub>	Reverse Recovery Time <sup>3</sup>	V <sub>GS</sub> =0V , I <sub>S</sub> =2A , dI/dt=100A/μs T <sub>J</sub> =25°C	---	170	---	ns
Q <sub>rr</sub>	Reverse Recovery Charge <sup>3</sup>		---	1.98	---	μC

Note :

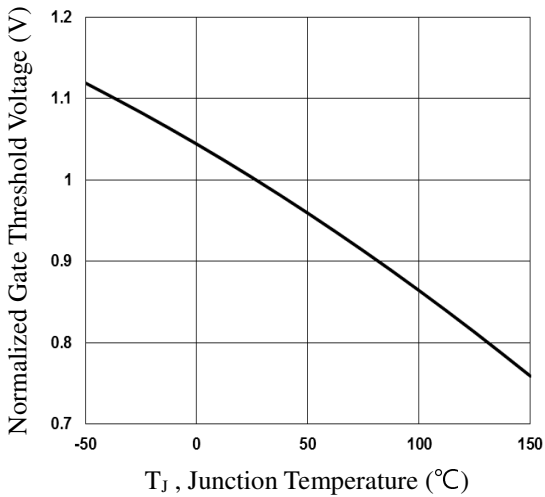
1. Repetitive Rating : Pulsed width limited by maximum junction temperature.
2. V<sub>DD</sub>=50V, V<sub>GS</sub>=10V, L=1mH, I<sub>AS</sub>=3.9A., R<sub>G</sub>=25Ω, Starting T<sub>J</sub>=25°C.
3. The data tested by pulsed , pulse width ≤ 300us , duty cycle ≤ 2%.
4. Essentially independent of operating temperature.



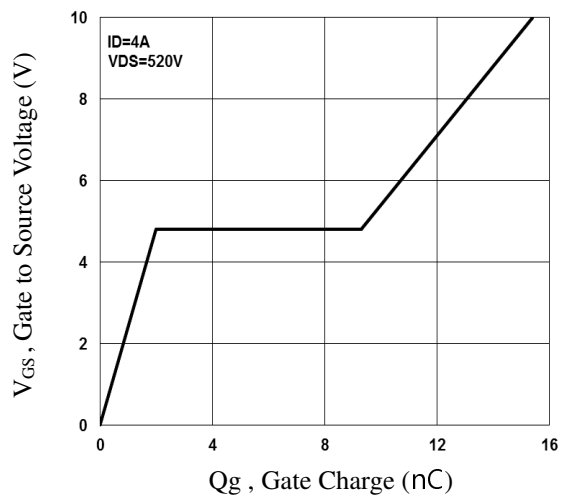
**Fig.1 Continuous Drain Current vs.  $T_c$**



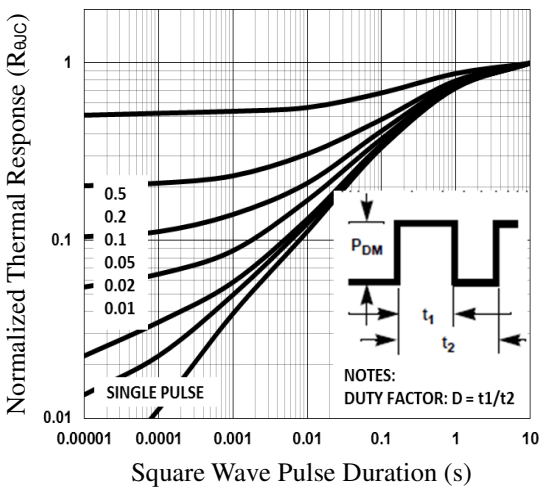
**Fig.2 Normalized  $R_{DS(on)}$  vs.  $T_j$**



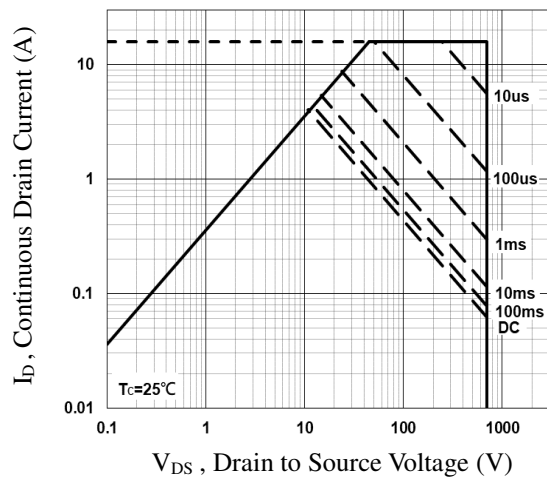
**Fig.3 Normalized  $V_{th}$  vs.  $T_j$**



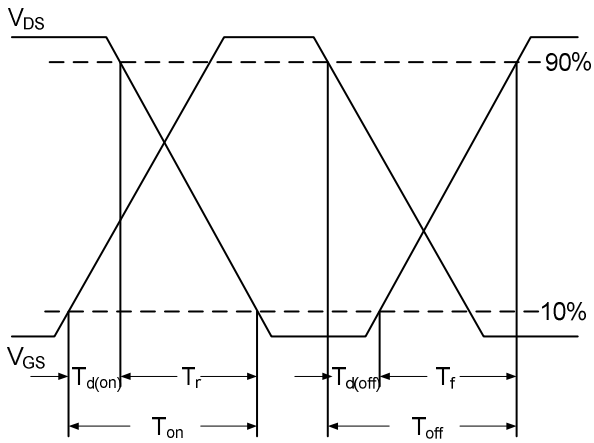
**Fig.4 Gate Charge Waveform**



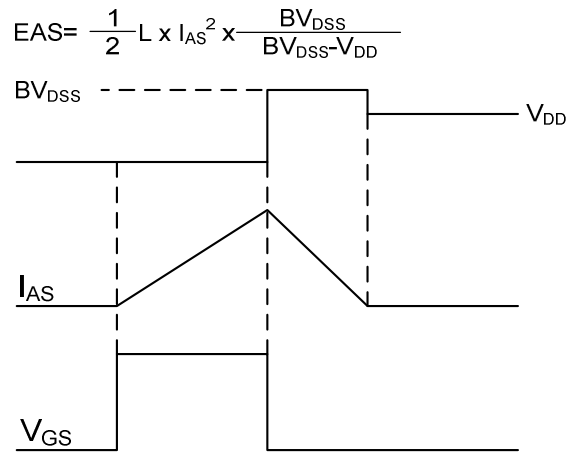
**Fig.5 Normalized Transient Impedance**



**Fig.6 Maximum Safe Operation Area**

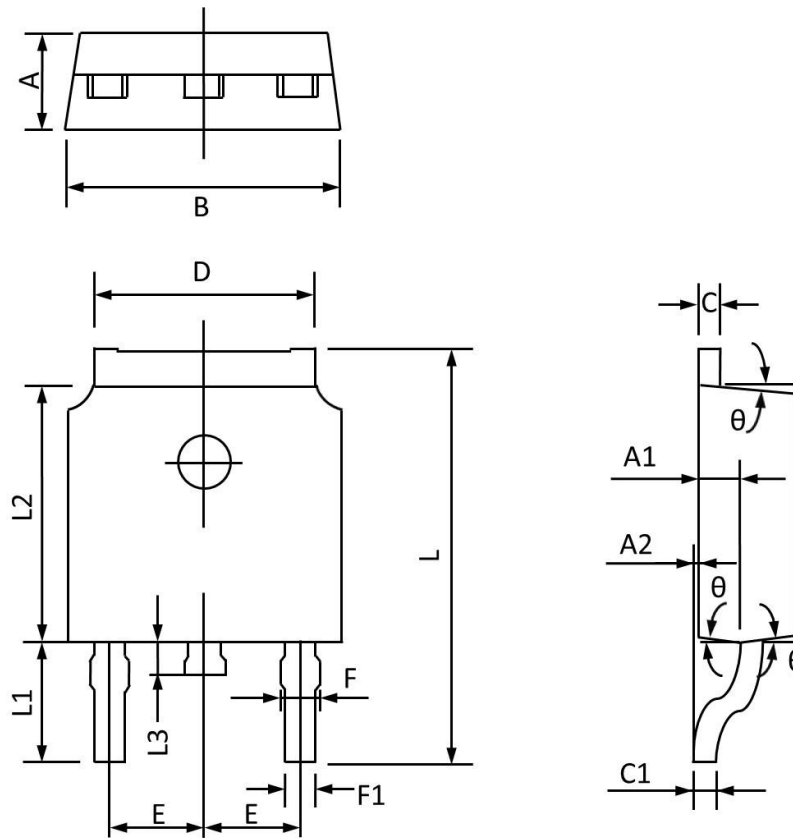


**Fig.7 Switching Time Waveform**



**Fig.8 EAS Waveform**

TO252 PACKAGE INFORMATION



Symbol	Dimensions In Millimeters		Dimensions In Inches	
	Min	Max	Min	Max
A	2.20	2.40	0.087	0.094
A1	0.91	1.11	0.036	0.044
A2	0.00	0.15	0.000	0.006
B	6.50	6.70	0.256	0.264
C	0.46	0.580	0.018	0.230
C1	0.46	0.580	0.018	0.030
D	5.10	5.46	0.201	0.215
E	2.186	2.386	0.086	0.094
F	0.74	0.94	0.029	0.037
F1	0.660	0.860	0.026	0.034
L	9.80	10.40	0.386	0.409
L1	2.9REF		0.114REF	
L2	6.00	6.20	0.236	0.244
L3	0.60	1.00	0.024	0.039
$\theta$	3°	9°	3°	9°