

### General Description

These N-Channel enhancement mode power field effect transistors are using trench DMOS technology. This advanced technology has been especially tailored to minimize on-state resistance, provide superior switching performance, and withstand high energy pulse in the avalanche and commutation mode. These devices are well suited for high efficiency fast switching applications.

|       |       |     |
|-------|-------|-----|
| BVDSS | RDSON | ID  |
| 100V  | 7.8mΩ | 70A |

### Features

- 100V,70A,  $R_{DS(ON)} = 7.8m\Omega @ V_{GS} = 10V$
- Improved  $dv/dt$  capability
- Fast switching
- 100% EAS Guaranteed
- Green Device Available

### TO252 Pin Configuration

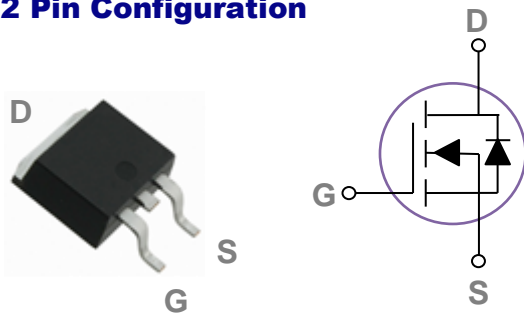

### Applications

- Networking
- Load Switch
- LED applications
- Quick Charger

### Absolute Maximum Ratings $T_c=25^\circ\text{C}$ unless otherwise noted

| Symbol    | Parameter  | Rating     | Units               |
|-----------|--|------------|---------------------|
| $V_{DS}$  | Drain-Source Voltage                                   | 100        | V                   |
| $V_{GS}$  | Gate-Source Voltage                                    | $\pm 20$   | V                   |
| $I_D$     | Drain Current – Continuous ( $T_c=25^\circ\text{C}$ )  | 70         | A                   |
|           | Drain Current – Continuous ( $T_c=100^\circ\text{C}$ ) | 45         | A                   |
| $I_{DM}$  | Drain Current – Pulsed <sup>1</sup>                    | 280        | A                   |
| EAS       | Single Pulse Avalanche Energy <sup>2</sup>             | 174        | mJ                  |
| IAS       | Single Pulse Avalanche Current <sup>2</sup>            | 59         | A                   |
| $P_D$     | Power Dissipation ( $T_c=25^\circ\text{C}$ )           | 94         | W                   |
|           | Power Dissipation – Derate above $25^\circ\text{C}$    | 0.75       | W/ $^\circ\text{C}$ |
| $T_{STG}$ | Storage Temperature Range                              | -55 to 150 | $^\circ\text{C}$    |
| $T_J$     | Operating Junction Temperature Range                   | -55 to 150 | $^\circ\text{C}$    |

### Thermal Characteristics

| Symbol          | Parameter                              | Typ. | Max. | Unit               |
|-----------------|--|------|------|--------------------|
| $R_{\theta JA}$ | Thermal Resistance Junction to ambient | ---  | 62   | $^\circ\text{C/W}$ |
| $R_{\theta JC}$ | Thermal Resistance Junction to Case    | ---  | 1.33 | $^\circ\text{C/W}$ |

**Electrical Characteristics (T<sub>J</sub>=25 °C, unless otherwise noted)**
**Off Characteristics**

| Symbol            | Parameter                      | Conditions  | Min. | Typ. | Max. | Unit |
|-------------------|--------------------------------|---|------|------|------|------|
| BV <sub>DSS</sub> | Drain-Source Breakdown Voltage | V <sub>GS</sub> =0V, I <sub>D</sub> =250μA                      | 100  | ---  | ---  | V    |
| I <sub>DSS</sub>  | Drain-Source Leakage Current   | V <sub>DS</sub> =80V, V <sub>GS</sub> =0V, T <sub>J</sub> =25°C | ---  | ---  | 1    | μA   |
|                   |                                | V <sub>DS</sub> =80V, V <sub>GS</sub> =0V, T <sub>J</sub> =85°C | ---  | ---  | 10   | μA   |
| I <sub>GSS</sub>  | Gate-Source Leakage Current    | V <sub>GS</sub> =±20V, V <sub>DS</sub> =0V                      | ---  | ---  | ±100 | nA   |

**On Characteristics**

|                     |                                   |  |     |     |      |    |
|---------------------|-----------------------------------|--|-----|-----|------|----|
| R <sub>DS(ON)</sub> | Static Drain-Source On-Resistance | V <sub>GS</sub> =10V, I <sub>D</sub> =15A                | --- | 6.5 | 7.8  | mΩ |
|                     |                                   | V <sub>GS</sub> =4.5V, I <sub>D</sub> =8A                | --- | 8   | 10.5 | mΩ |
| V <sub>GS(th)</sub> | Gate Threshold Voltage            | V <sub>GS</sub> =V <sub>DS</sub> , I <sub>D</sub> =250μA | 1.2 | 1.6 | 2.5  | V  |
| g <sub>fs</sub>     | Forward Transconductance          | V <sub>DS</sub> =10V, I <sub>D</sub> =3A                 | --- | 17  | ---  | S  |

**Dynamic and switching Characteristics**

|                     |                                     |   |     |      |      |    |
|---------------------|-------------------------------------|---|-----|------|------|----|
| Q <sub>g</sub>      | Total Gate Charge <sup>3, 4</sup>   | V <sub>DS</sub> =50V, V <sub>GS</sub> =10V, I <sub>D</sub> =35A                       | --- | 39.1 | 58   | nC |
| Q <sub>gs</sub>     | Gate-Source Charge <sup>3, 4</sup>  |   | --- | 4.4  | 6.6  |    |
| Q <sub>gd</sub>     | Gate-Drain Charge <sup>3, 4</sup>   |   | --- | 12.3 | 18   |    |
| T <sub>d(on)</sub>  | Turn-On Delay Time <sup>3, 4</sup>  | V <sub>DD</sub> =50V, V <sub>GS</sub> =10V, R <sub>G</sub> =6Ω<br>I <sub>D</sub> =35A | --- | 14.6 | 30   | ns |
| T <sub>r</sub>      | Rise Time <sup>3, 4</sup>           |   | --- | 21.5 | 44   |    |
| T <sub>d(off)</sub> | Turn-Off Delay Time <sup>3, 4</sup> |   | --- | 54   | 108  |    |
| T <sub>f</sub>      | Fall Time <sup>3, 4</sup>           |   | --- | 84.3 | 168  |    |
| C <sub>iss</sub>    | Input Capacitance                   | V <sub>DS</sub> =50V, V <sub>GS</sub> =0V, F=1MHz                                     | --- | 1990 | 2980 | pF |
| C <sub>oss</sub>    | Output Capacitance                  |   | --- | 370  | 560  |    |
| C <sub>rss</sub>    | Reverse Transfer Capacitance        |   | --- | 10   | 15   |    |
| R <sub>g</sub>      | Gate resistance                     | V <sub>GS</sub> =0V, V <sub>DS</sub> =0V, F=1MHz                                      | --- | 1.2  | ---  | Ω  |

**Drain-Source Diode Characteristics and Maximum Ratings**

| Symbol          | Parameter                 | Conditions  | Min. | Typ. | Max. | Unit |
|-----------------|---------------------------|---|------|------|------|------|
| I <sub>S</sub>  | Continuous Source Current | V <sub>G</sub> =V <sub>D</sub> =0V, Force Current             | ---  | ---  | 70   | A    |
| I <sub>SM</sub> | Pulsed Source Current     |   | ---  | ---  | 140  | A    |
| V <sub>SD</sub> | Diode Forward Voltage     | V <sub>GS</sub> =0V, I <sub>S</sub> =1A, T <sub>J</sub> =25°C | ---  | ---  | 1    | V    |
| t <sub>rr</sub> | Reverse Recovery Time     | V <sub>R</sub> =100V, I <sub>S</sub> =10A                     | ---  | 240  | ---  | ns   |
| Q <sub>rr</sub> | Reverse Recovery Charge   | di/dt=100A/μs, T <sub>J</sub> =25°C                           | ---  | 460  | ---  | nC   |

Note :

1. Repetitive Rating : Pulsed width limited by maximum junction temperature.
2. V<sub>DD</sub>=50V, V<sub>GS</sub>=10V, L=0.1mH, I<sub>AS</sub>=59A., R<sub>G</sub>=25Ω, Starting T<sub>J</sub>=25°C.
3. The data tested by pulsed, pulse width ≤ 300us, duty cycle ≤ 2%.
4. Essentially independent of operating temperature.

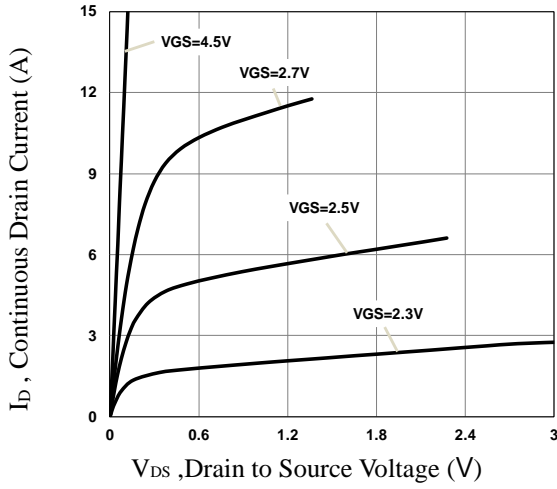

**Fig.1 Typical Output Characteristics**

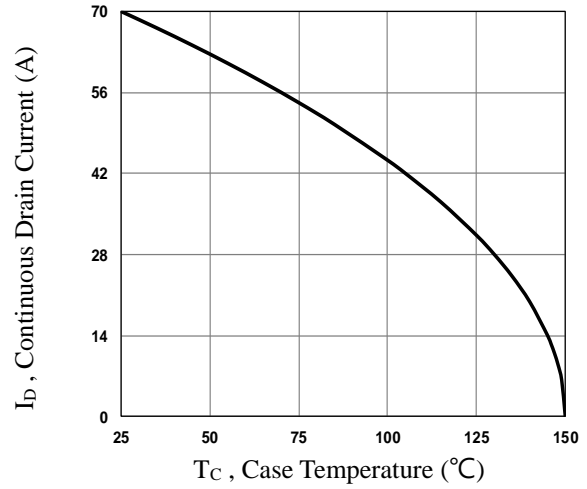

**Fig.2 Continuous Drain Current vs. T<sub>c</sub>**

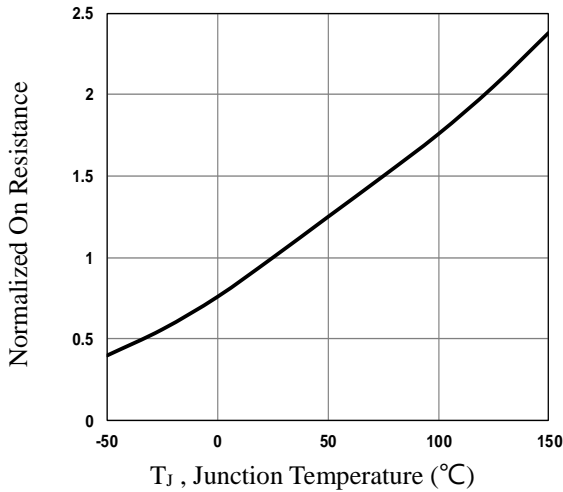

**Fig.3 Normalized R<sub>DS(on)</sub> vs. T<sub>j</sub>**

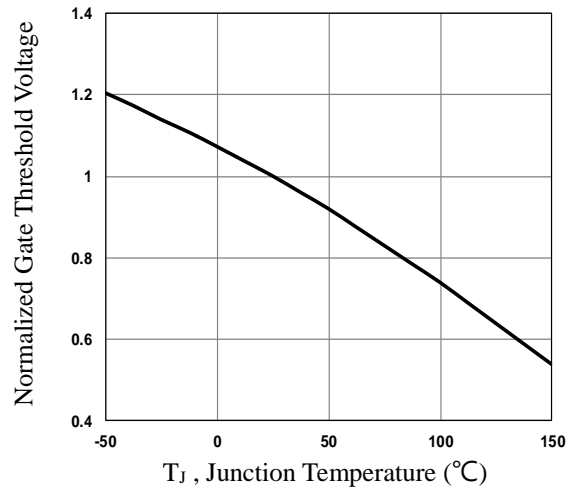

**Fig.4 Normalized V<sub>th</sub> vs. T<sub>j</sub>**

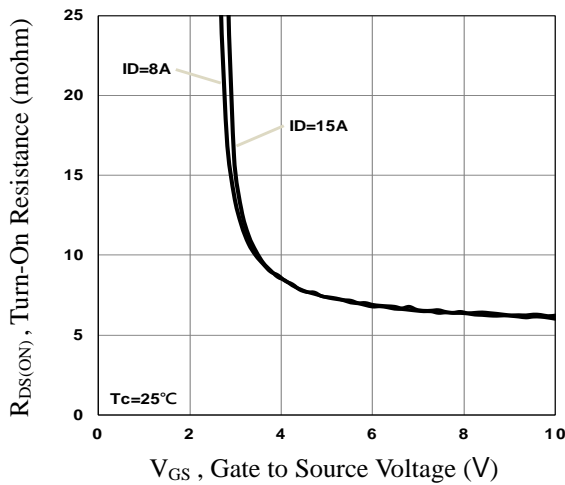

**Fig.5 Turn-On Resistance vs. V<sub>GS</sub>**

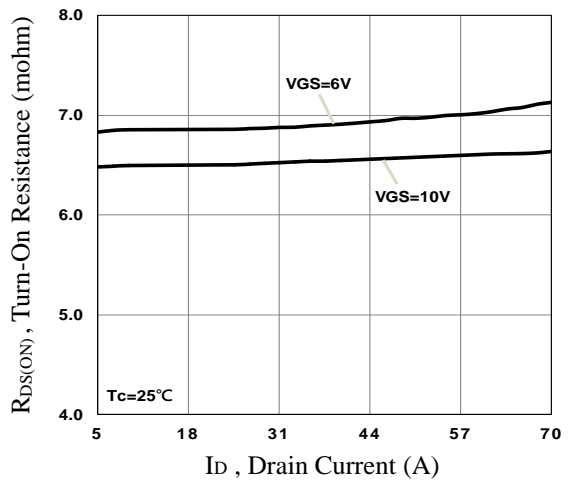

**Fig.6 Turn-On Resistance vs. I<sub>D</sub>**

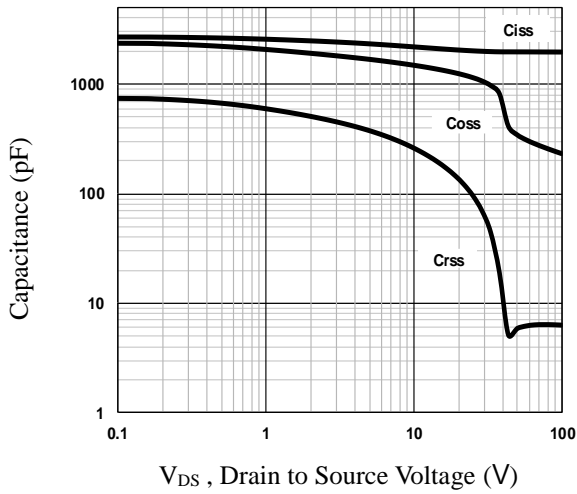

**Fig.7 Capacitance Characteristics**

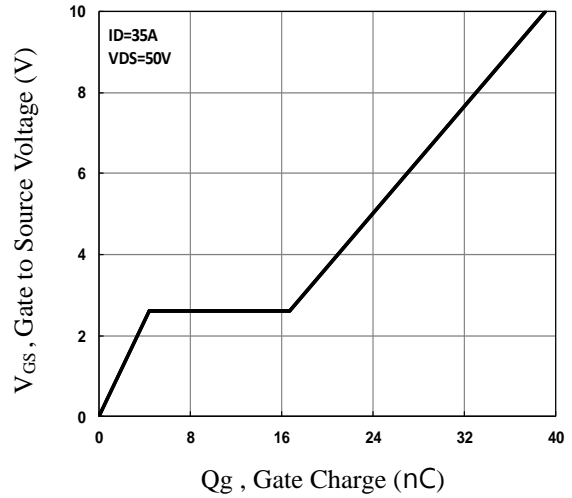

**Fig.8 Gate Charge Characteristics**



**Fig.9 Normalized Transient Impedance**

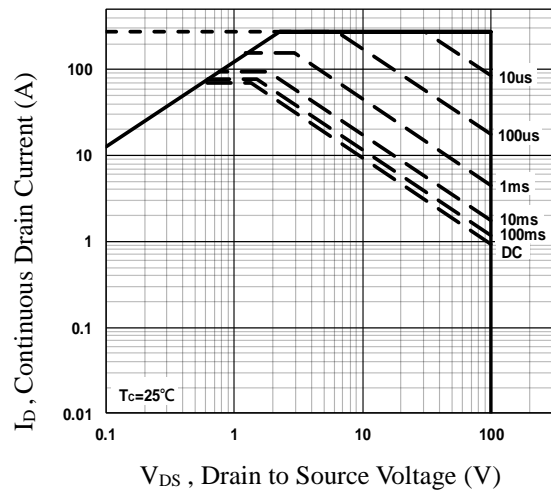

**Fig.10 Maximum Safe Operation Area**



**Fig.11 Switching Time Waveform**

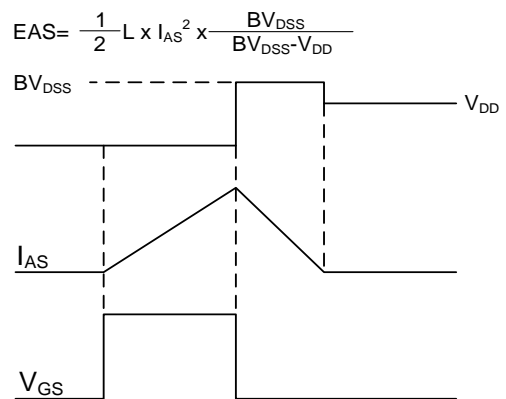

**Fig.12 EAS Waveform**

## TO252 PACKAGE INFORMATION



| Symbol   | Dimensions In Millimeters |       | Dimensions In Inches |       |
|----------|---------------------------|-------|----------------------|-------|
|          | MAX                       | MIN   | MAX                  | MIN   |
| A        | 2.450                     | 2.150 | 0.096                | 0.085 |
| A1       | 1.200                     | 0.910 | 0.047                | 0.036 |
| A2       | 0.150                     | 0.000 | 0.006                | 0.000 |
| B        | 6.800                     | 6.300 | 0.268                | 0.248 |
| C        | 0.580                     | 0.350 | 0.023                | 0.014 |
| C1       | 0.550                     | 0.380 | 0.022                | 0.015 |
| D        | 5.500                     | 5.100 | 0.217                | 0.201 |
| E        | 2.390                     | 2.000 | 0.094                | 0.079 |
| F        | 0.940                     | 0.600 | 0.037                | 0.024 |
| F1       | 0.860                     | 0.500 | 0.034                | 0.020 |
| L        | 10.400                    | 9.400 | 0.409                | 0.370 |
| L1       | 3.000                     | 2.400 | 0.118                | 0.094 |
| L2       | 6.200                     | 5.300 | 0.244                | 0.209 |
| L3       | 1.200                     | 0.600 | 0.047                | 0.024 |
| $\theta$ | 9°                        | 3°    | 9°                   | 3°    |