

General Description

These N-Channel enhancement mode power field effect transistors are using trench DMOS technology. This advanced technology has been especially tailored to minimize on-state resistance, provide superior switching performance, and withstand high energy pulse in the avalanche and commutation mode. These devices are well suited for high efficiency fast switching applications.

BVDSS	RDSON	ID
100V	85mΩ	15A

Features

- 100V, 15A, $R_{DS(ON)} = 85m\Omega @ V_{GS} = 10V$
- Improved dv/dt capability
- Fast switching
- 100% EAS Guaranteed
- Green Device Available

TO251 Pin Configuration

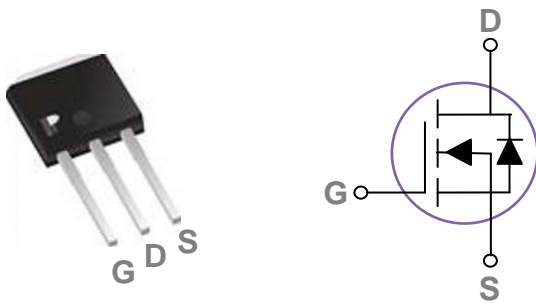

Applications

- Networking
- Load Switch
- LED applications

Absolute Maximum Ratings $T_C=25^\circ\text{C}$ unless otherwise noted

Symbol	Parameter	Rating	Units
V_{DS}	Drain-Source Voltage	100	V
V_{GS}	Gate-Source Voltage	± 20	V
I_D	Drain Current – Continuous ($T_C=25^\circ\text{C}$)	15	A
	Drain Current – Continuous ($T_C=100^\circ\text{C}$)	9.5	A
I_{DM}	Drain Current – Pulsed ¹	60	A
EAS	Single Pulse Avalanche Energy ⁴	18	mJ
IAS	Single Pulse Avalanche Current ⁴	19	A
P_D	Power Dissipation ($T_C=25^\circ\text{C}$)	40	W
	Power Dissipation – Derate above 25°C	0.32	W/ $^\circ\text{C}$
T_{STG}	Storage Temperature Range	-50 to 150	$^\circ\text{C}$
T_J	Operating Junction Temperature Range	-50 to 150	$^\circ\text{C}$

Thermal Characteristics

Symbol	Parameter	Typ.	Max.	Unit
$R_{\theta JA}$	Thermal Resistance Junction to ambient	---	62	$^\circ\text{C}/\text{W}$
$R_{\theta JC}$	Thermal Resistance Junction to Case	---	3.1	$^\circ\text{C}/\text{W}$

Electrical Characteristics ($T_J=25^\circ\text{C}$, unless otherwise noted)
Off Characteristics

Symbol	Parameter	Conditions	Min.	Typ.	Max.	Unit
BV_{DSS}	Drain-Source Breakdown Voltage	$V_{GS}=0V, I_D=250\mu A$	100	---	---	V
I_{DSS}	Drain-Source Leakage Current	$V_{DS}=100V, V_{GS}=0V, T_J=25^\circ\text{C}$	---	---	1	μA
		$V_{DS}=80V, V_{GS}=0V, T_J=125^\circ\text{C}$	---	---	10	μA
I_{GSS}	Gate-Source Leakage Current	$V_{GS}=\pm 20V, V_{DS}=0V$	---	---	± 100	nA

On Characteristics

$R_{DS(ON)}$	Static Drain-Source On-Resistance	$V_{GS}=10V, I_D=6A$	---	65	85	$m\Omega$
$V_{GS(th)}$	Gate Threshold Voltage	$V_{GS}=V_{DS}, I_D=250\mu A$	2	3	4	V
g_{fs}	Forward Transconductance	$V_{DS}=10V, I_D=3A$	---	6	---	S

Dynamic and switching Characteristics

Q_g	Total Gate Charge ^{2,3}	$V_{DS}=50V, V_{GS}=10V, I_D=6A$	---	10.5	20	nC
Q_{gs}	Gate-Source Charge ^{2,3}		---	4.8	9	
Q_{gd}	Gate-Drain Charge ^{2,3}		---	2.9	6	
$T_{d(on)}$	Turn-On Delay Time ^{2,3}	$V_{DD}=50V, V_{GS}=10V, R_G=25\Omega$ $I_D=1A$	---	73	140	ns
T_r	Rise Time ^{2,3}		---	36	72	
$T_{d(off)}$	Turn-Off Delay Time ^{2,3}		---	124	240	
T_f	Fall Time ^{2,3}		---	25	50	
C_{iss}	Input Capacitance	$V_{DS}=50V, V_{GS}=0V, F=1\text{MHz}$	---	615	1200	pF
C_{oss}	Output Capacitance		---	47	80	
C_{riss}	Reverse Transfer Capacitance		---	29	60	
R_g	Gate resistance	$V_{GS}=0V, V_{DS}=0V, F=1\text{MHz}$	---	2.1	4	Ω

Drain-Source Diode Characteristics and Maximum Ratings

Symbol	Parameter	Conditions	Min.	Typ.	Max.	Unit
I_S	Continuous Source Current	$V_G=V_D=0V, \text{Force Current}$	---	---	15	A
I_{SM}	Pulsed Source Current		---	---	30	A
V_{SD}	Diode Forward Voltage	$V_{GS}=0V, I_S=1A, T_J=25^\circ\text{C}$	---	---	1	V
t_{rr}	Reverse Recovery Time ²	$I_S=1A, di/dt=100A/\mu s, T_J=25^\circ\text{C}$	---	18.5	---	ns
Q_{rr}	Reverse Recovery Charge ²		---	16	---	nC

Note :

1. Repetitive Rating : Pulsed width limited by maximum junction temperature.
2. The data tested by pulsed , pulse width $\leq 300\mu s$, duty cycle $\leq 2\%$.
3. Essentially independent of operating temperature.
4. $V_{DD}=50V, V_{GS}=10V, L=0.1mH, I_{AS}=19A, R_G=25\Omega$, Starting $T_J=25^\circ\text{C}$.

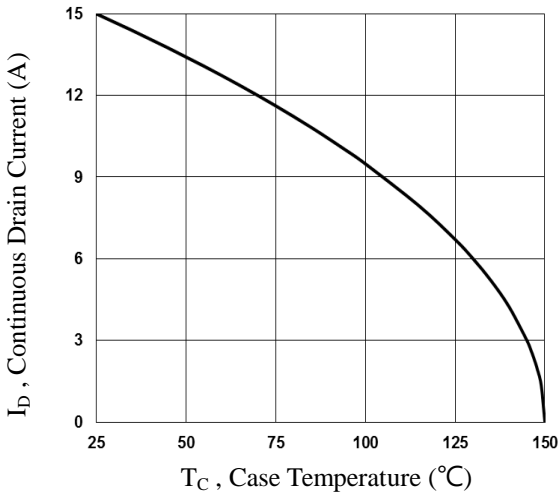

Fig.1 Continuous Drain Current vs. TC

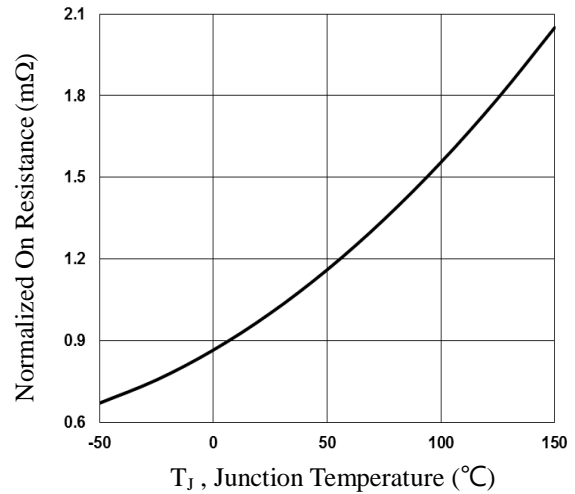

Fig.2 Normalized RDSON vs. TJ

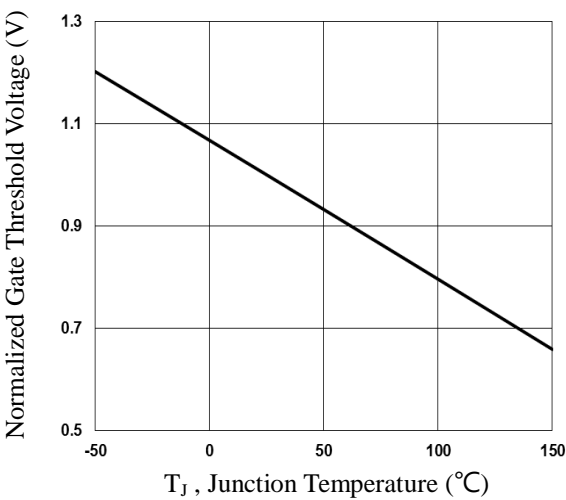

Fig.3 Normalized Vth vs. TJ

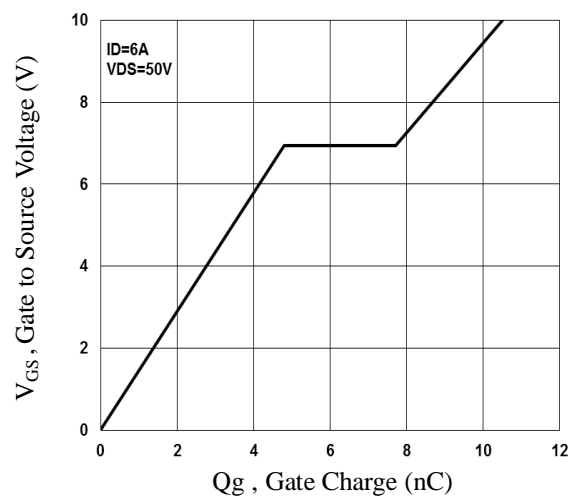

Fig.4 Gate Charge Characteristics

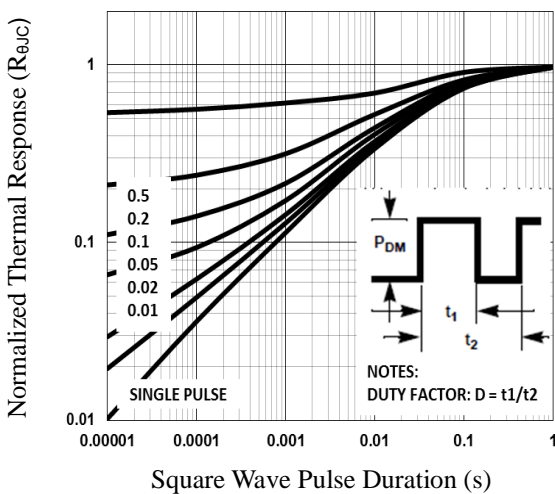

Fig.5 Normalized Transient Impedance

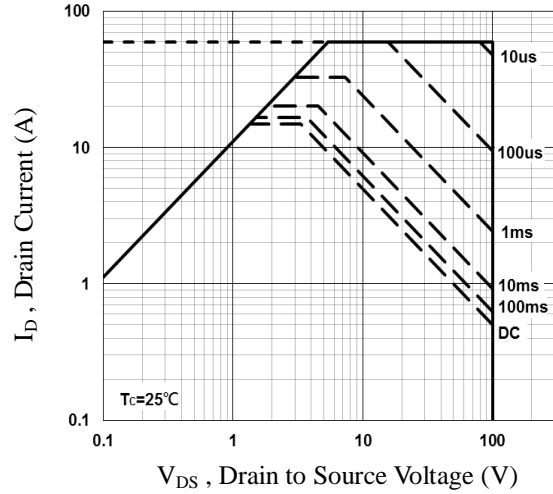

Fig.6 Maximum Safe Operation Area

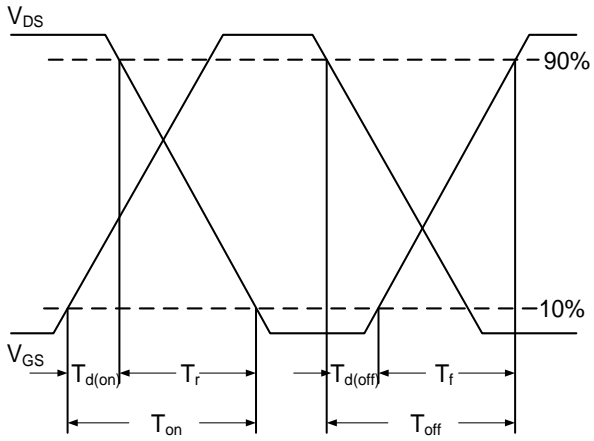

Fig.7 Switching Time Waveform

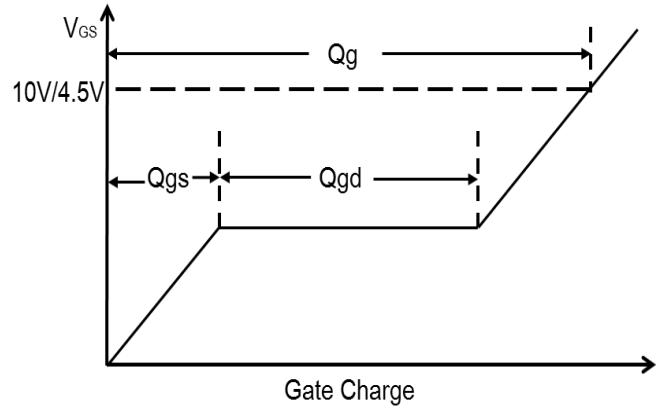
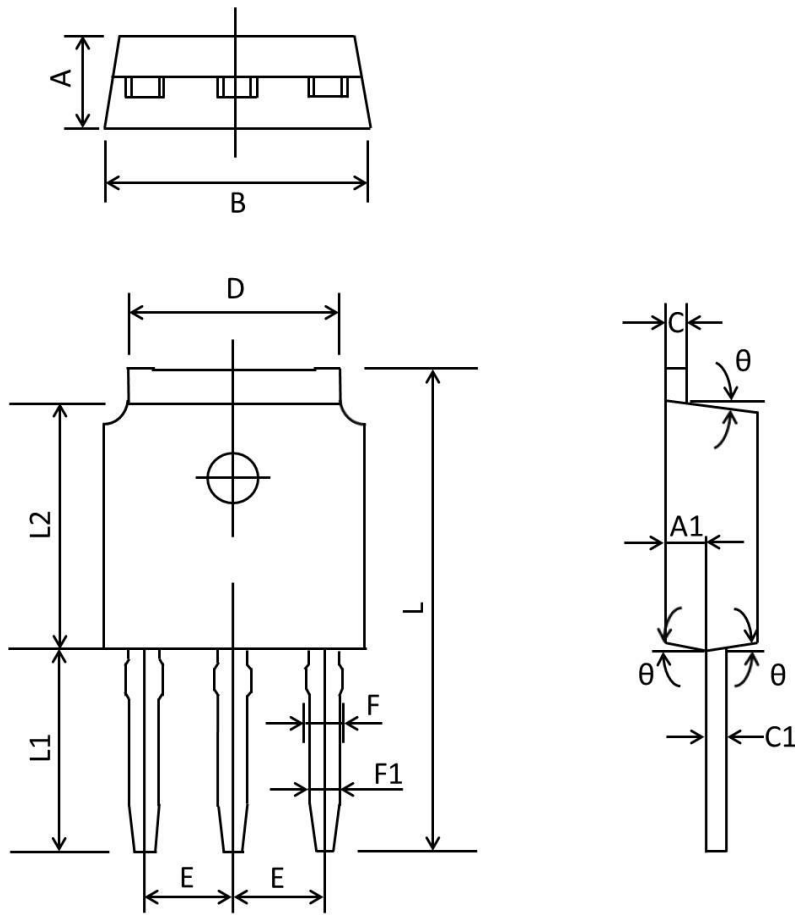

Fig.8 Gate Charge Waveform

TO251 PACKAGE INFORMATION



Symbol	Dimensions In Millimeters		Dimensions In Inches	
	Min	Max	Min	Max
A	2.20	2.40	0.087	0.094
A1	0.91	1.11	0.036	0.044
B	6.50	6.70	0.256	0.264
C	0.46	0.580	0.018	0.230
C1	0.46	0.580	0.018	0.030
D	5.10	5.46	0.201	0.215
E	2.186	2.386	0.086	0.094
F	0.74	0.94	0.029	0.037
F1	0.660	0.860	0.026	0.034
L	11.70	12.30	0.461	0.484
L1	4.8	5.2	0.189	0.205
L2	6.00	6.20	0.236	0.244
θ	3°	9°	3°	9°