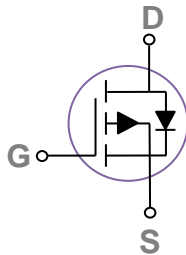
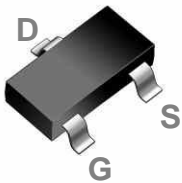


### General Description

These P-Channel enhancement mode power field effect transistors are using trench DMOS technology. This advanced technology has been especially tailored to minimize on-state resistance, provide superior switching performance, and withstand high energy pulse in the avalanche and commutation mode. These devices are well suited for high efficiency fast switching applications.

### SOT23-3 Pin Configuration



BVDSS	RDSON	ID
-20V	26mΩ	-6.5A

### Features

- -20V, -6.5A,  $R_{DS(ON)} = 26m\Omega @ V_{GS} = -4.5V$
- Improved  $dv/dt$  capability
- Fast switching
- Green Device Available
- Suit for -1.8V Gate Drive Applications

### Applications

- Notebook
- Load Switch
- Networking

### Absolute Maximum Ratings $T_c=25^\circ C$ unless otherwise noted

Symbol	Parameter	Rating	Units
$V_{DS}$	Drain-Source Voltage	-20	V
$V_{GS}$	Gate-Source Voltage	$\pm 10$	V
$I_D$	Drain Current – Continuous ( $T_A=25^\circ C$ )	-6.5	A
	Drain Current – Continuous ( $T_A=70^\circ C$ )	-5.2	A
$I_{DM}$	Drain Current – Pulsed <sup>1</sup>	-26	A
$P_D$	Power Dissipation ( $T_c=25^\circ C$ )	1.56	W
	Power Dissipation – Derate above 25°C	0.012	W/°C
$T_{STG}$	Storage Temperature Range	-55 to 150	°C
$T_J$	Operating Junction Temperature Range	-55 to 150	°C

### Thermal Characteristics

Symbol	Parameter	Typ.	Max.	Unit
$R_{\theta JA}$	Thermal Resistance Junction to ambient	---	80	°C/W

**Electrical Characteristics ( $T_J=25\text{ }^\circ\text{C}$ , unless otherwise noted)**
**Off Characteristics**

Symbol	Parameter	Conditions	Min.	Typ.	Max.	Unit
$BV_{DSS}$	Drain-Source Breakdown Voltage	$V_{GS}=0V, I_D=-250\mu A$	-20	---	---	V
$\Delta BV_{DSS}/\Delta T_J$	$BV_{DSS}$ Temperature Coefficient	Reference to $25^\circ\text{C}$ , $I_D=-1\text{mA}$	---	-0.01	---	$V/^\circ\text{C}$
$I_{DSS}$	Drain-Source Leakage Current	$V_{DS}=-20V, V_{GS}=0V, T_J=25^\circ\text{C}$	---	---	-1	$\mu A$
		$V_{DS}=-16V, V_{GS}=0V, T_J=125^\circ\text{C}$	---	---	-10	$\mu A$
$I_{GSS}$	Gate-Source Leakage Current	$V_{GS}=\pm 10V, V_{DS}=0V$	---	---	$\pm 100$	nA

**On Characteristics**

$R_{DS(ON)}$	Static Drain-Source On-Resistance	$V_{GS}=-4.5V, I_D=-5A$	---	20	26	m $\Omega$
		$V_{GS}=-2.5V, I_D=-4A$	---	25	32	
		$V_{GS}=-1.8V, I_D=-3A$	---	31	40	
$V_{GS(th)}$	Gate Threshold Voltage	$V_{GS}=V_{DS}, I_D=-250\mu A$	-0.3	-0.6	-1.0	V
$\Delta V_{GS(th)}$	$V_{GS(th)}$ Temperature Coefficient		---	3	---	$\text{mV}/^\circ\text{C}$
gfs	Forward Transconductance	$V_{DS}=-10V, I_S=-5A$	---	15	---	S

**Dynamic and switching Characteristics**

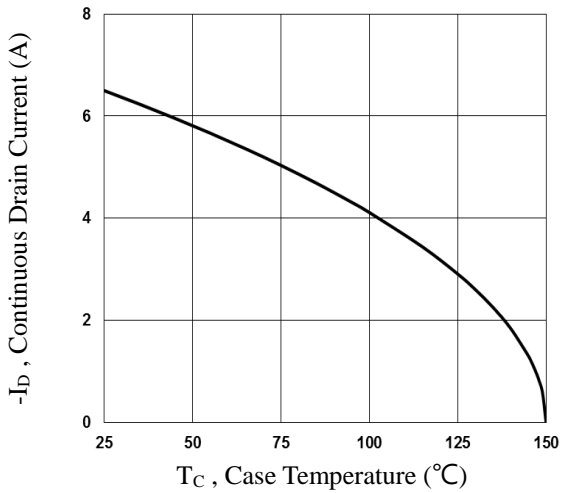
$Q_g$	Total Gate Charge <sup>2,3</sup>	$V_{DS}=-10V, V_{GS}=-4.5V, I_D=-5A$	---	19.5	29	nC
$Q_{gs}$	Gate-Source Charge <sup>2,3</sup>		---	2	4	
$Q_{gd}$	Gate-Drain Charge <sup>2,3</sup>		---	3.6	7	
$T_{d(on)}$	Turn-On Delay Time <sup>2,3</sup>	$V_{DD}=-10V, V_{GS}=-4.5V, R_G=25\Omega, I_D=-1A$	---	10.4	20	nS
$T_r$	Rise Time <sup>2,3</sup>		---	37.5	71	
$T_{d(off)}$	Turn-Off Delay Time <sup>2,3</sup>		---	89.1	129	
$T_f$	Fall Time <sup>2,3</sup>		---	24.6	47	
$C_{iss}$	Input Capacitance	$V_{DS}=-15V, V_{GS}=0V, F=1\text{MHz}$	---	1670	2430	pF
$C_{oss}$	Output Capacitance		---	220	320	
$C_{rss}$	Reverse Transfer Capacitance		---	120	180	

**Drain-Source Diode Characteristics and Maximum Ratings**

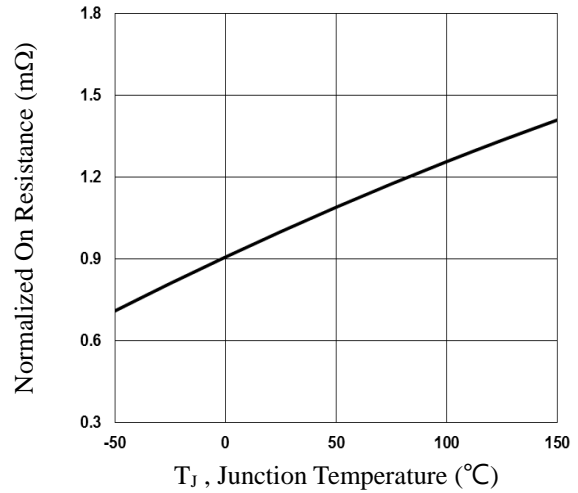
Symbol	Parameter	Conditions	Min.	Typ.	Max.	Unit
$I_S$	Continuous Source Current	$V_G=V_D=0V$ , Force Current	---	---	-6.5	A
$I_{SM}$	Pulsed Source Current		---	---	-26	A
$V_{SD}$	Diode Forward Voltage	$V_{GS}=0V, I_S=-1A, T_J=25^\circ\text{C}$	---	---	-1	V

Note :

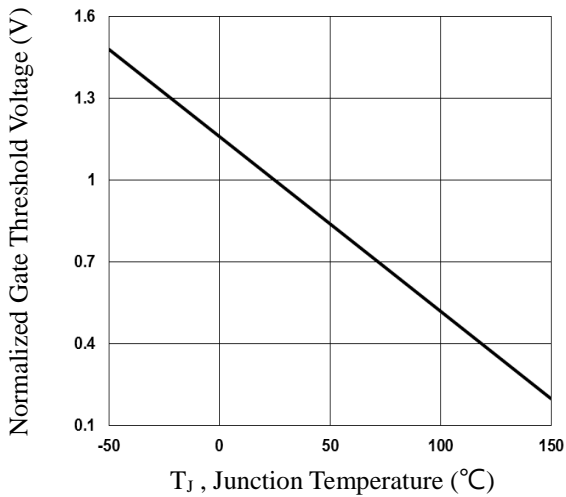
1. Repetitive Rating : Pulsed width limited by maximum junction temperature.
2. The data tested by pulsed , pulse width  $\leq 300\mu s$ , duty cycle  $\leq 2\%$ .
3. Essentially independent of operating temperature.



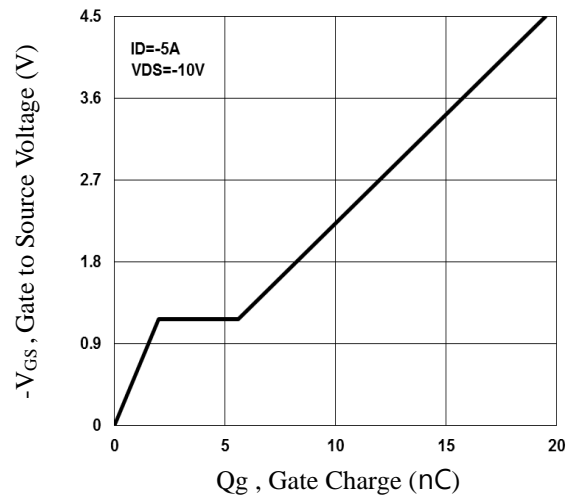
**Fig.1 Continuous Drain Current vs.  $T_c$**



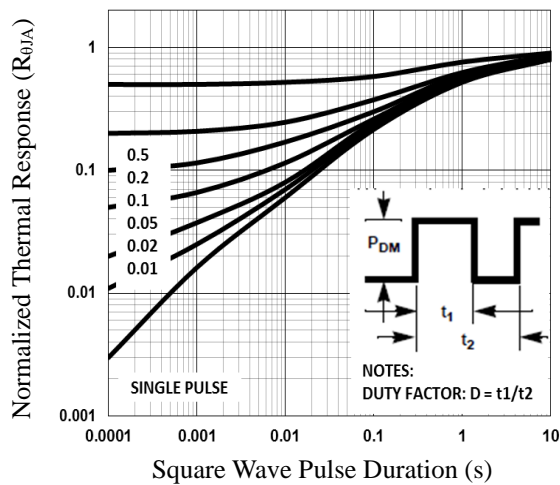
**Fig.2 Normalized  $R_{DS(on)}$  vs.  $T_j$**



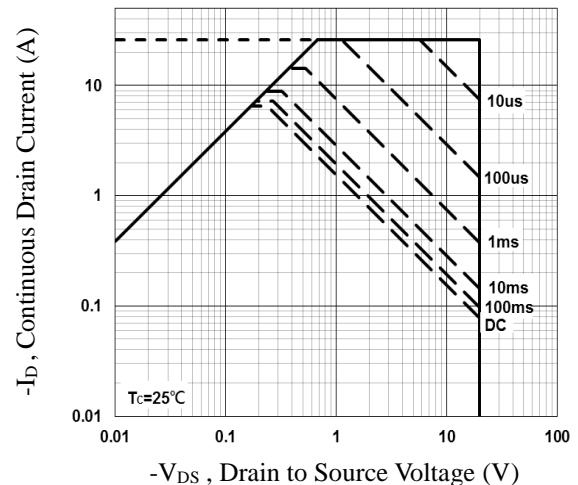
**Fig.3 Normalized  $V_{th}$  vs.  $T_j$**



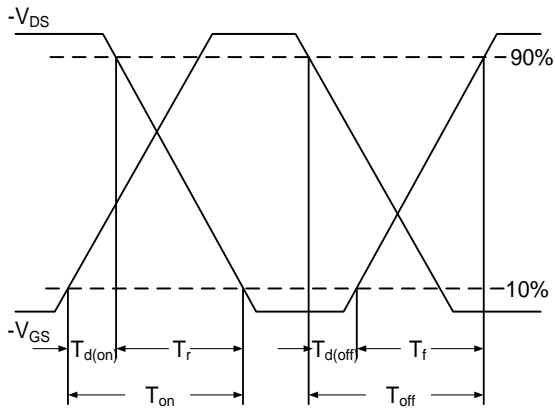
**Fig.4 Gate Charge Waveform**



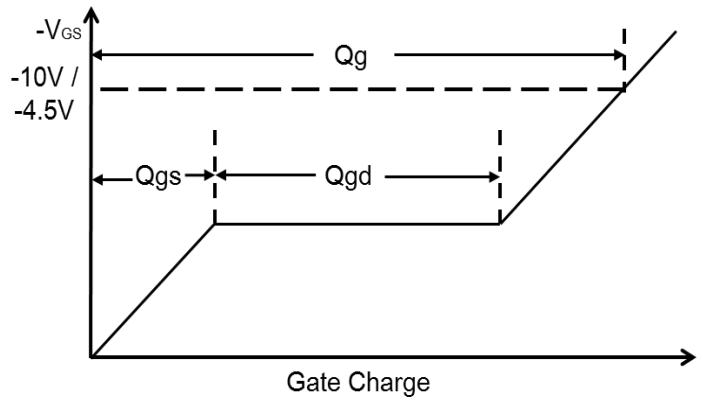
**Fig.5 Normalized Transient Impedance**



**Fig.6 Maximum Safe Operation Area**

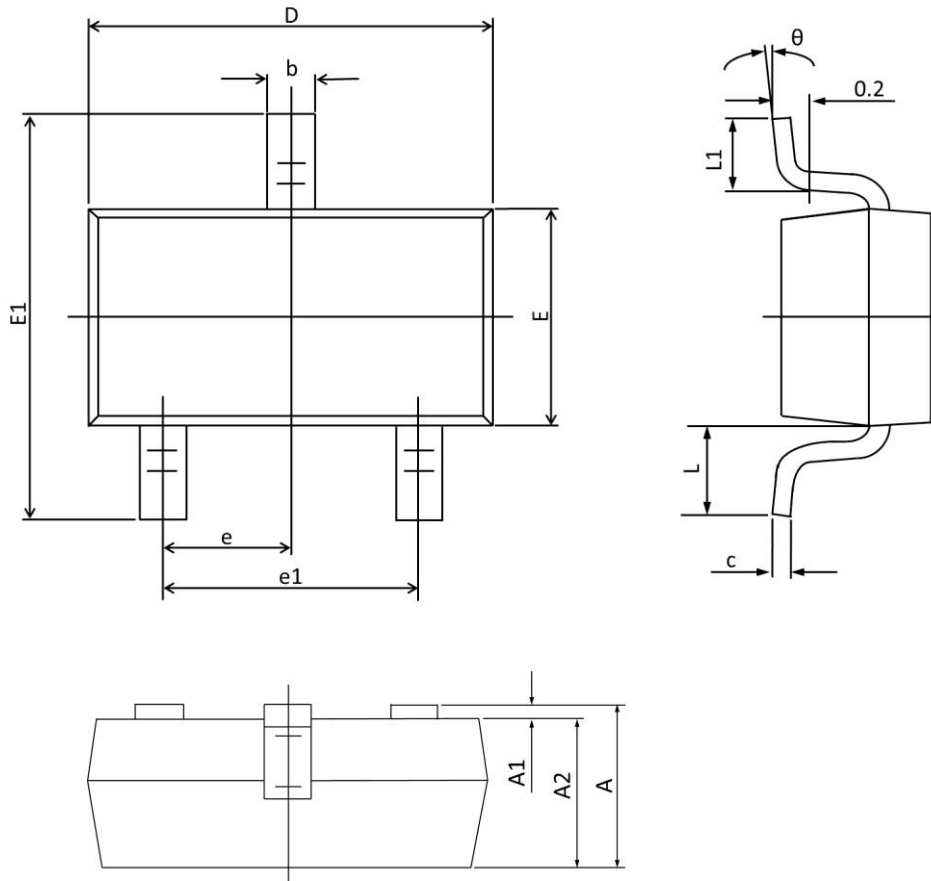


**Fig.7 Switching Time Waveform**



**Fig.8 Gate Charge Waveform**

## SOT23-3 PACKAGE INFORMATION



Symbol	Dimensions In Millimeters		Dimensions In Inches	
	Min	Max	Min	Max
A	1.050	1.250	0.041	0.049
A1	0.000	0.100	0.000	0.004
A2	1.050	1.150	0.041	0.045
b	0.300	0.400	0.012	0.016
c	0.100	0.200	0.004	0.008
D	2.820	3.020	0.111	0.119
E	1.500	1.700	0.059	0.067
E1	2.650	2.950	0.104	0.116
e	0.950 TYP.		0.037 TYP.	
e1	1.800	2.000	0.071	0.079
L	0.700 REF.		0.028 REF.	
L1	0.300	0.600	0.012	0.024
$\theta$	0°	8°	0°	8°