

### General Description

These N-Channel enhancement mode power field effect transistors are using trench DMOS technology. This advanced technology has been especially tailored to minimize on-state resistance, provide superior switching performance, and withstand high energy pulse in the avalanche and commutation mode. These devices are well suited for high efficiency fast switching applications.

BVDSS	RDSON	ID
100V	310mΩ	1.7A

### Features

- 100V, 1.7A ,  $R_{DS(ON)}=310m\Omega@V_{GS}=10V$
- Improved  $dv/dt$  capability
- Fast switching
- Green Device Available

### SOT223 Pin Configuration

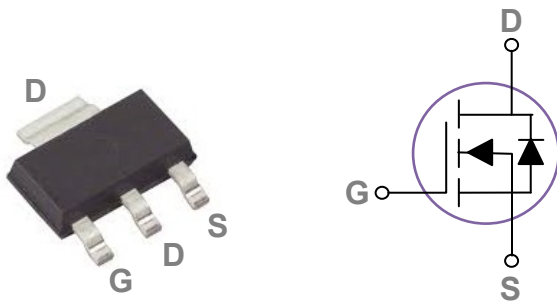

### Applications

- Networking
- Load Switch
- LED applications

### Absolute Maximum Ratings $T_c=25^\circ\text{C}$ unless otherwise noted

Symbol	Parameter	Rating	Units
$V_{DS}$	Drain-Source Voltage	100	V
$V_{GS}$	Gate-Source Voltage	$\pm 20$	V
$I_D$	Drain Current – Continuous ( $T_c=25^\circ\text{C}$ )	1.7	A
	Drain Current – Continuous ( $T_c=100^\circ\text{C}$ )	1.08	A
$I_{DM}$	Drain Current – Pulsed <sup>1</sup>	6.8	A
$P_D$	Power Dissipation ( $T_c=25^\circ\text{C}$ )	1.76	W
	Power Dissipation – Derate above $25^\circ\text{C}$	0.014	W/ $^\circ\text{C}$
$T_{STG}$	Storage Temperature Range	-50 to 150	$^\circ\text{C}$
$T_J$	Operating Junction Temperature Range	-50 to 150	$^\circ\text{C}$

### Thermal Characteristics

Symbol	Parameter	Typ.	Max.	Unit
$R_{\theta JA}$	Thermal Resistance Junction to ambient	---	70	$^\circ\text{C}/\text{W}$
$R_{\theta JC}$	Thermal Resistance Junction to Case	---	30	$^\circ\text{C}/\text{W}$

**Electrical Characteristics ( $T_J=25^\circ\text{C}$ , unless otherwise noted)**
**Off Characteristics**

Symbol	Parameter	Conditions	Min.	Typ.	Max.	Unit
$BV_{DSS}$	Drain-Source Breakdown Voltage	$V_{GS}=0V, I_D=250\mu A$	100	---	---	V
$\Delta BV_{DSS}/\Delta T_J$	$BV_{DSS}$ Temperature Coefficient	Reference to $25^\circ\text{C}$ , $I_D=1\text{mA}$	---	0.09	---	$V/^\circ\text{C}$
$I_{DSS}$	Drain-Source Leakage Current	$V_{DS}=100V, V_{GS}=0V, T_J=25^\circ\text{C}$	---	---	1	$\mu A$
		$V_{DS}=80V, V_{GS}=0V, T_J=125^\circ\text{C}$	---	---	10	$\mu A$
$I_{GSS}$	Gate-Source Leakage Current	$V_{GS}=\pm 20V, V_{DS}=0V$	---	---	$\pm 100$	nA

**On Characteristics**

$R_{DS(ON)}$	Static Drain-Source On-Resistance	$V_{GS}=10V, I_D=1A$	---	260	310	m $\Omega$
		$V_{GS}=4.5V, I_D=0.5A$	---	270	320	m $\Omega$
$V_{GS(th)}$	Gate Threshold Voltage	$V_{GS}=V_{DS}, I_D=250\mu A$	1.2	1.8	2.5	V
$\Delta V_{GS(th)}$	$V_{GS(th)}$ Temperature Coefficient		---	-5	---	$\text{mV}/^\circ\text{C}$
gfs	Forward Transconductance	$V_{DS}=10V, I_D=2A$	---	2.3	---	S

**Dynamic and switching Characteristics**

$Q_g$	Total Gate Charge <sup>2,3</sup>	$V_{DS}=50V, V_{GS}=10V, I_D=1A$	---	9	18	nC
$Q_{gs}$	Gate-Source Charge <sup>2,3</sup>		---	2.3	4.6	
$Q_{gd}$	Gate-Drain Charge <sup>2,3</sup>		---	1.1	2.5	
$T_{d(on)}$	Turn-On Delay Time <sup>2,3</sup>	$V_{DD}=50V, V_{GS}=10V, R_G=3.3\Omega, I_D=1A$	---	5.2	10	ns
$T_r$	Rise Time <sup>2,3</sup>		---	6.8	12	
$T_{d(off)}$	Turn-Off Delay Time <sup>2,3</sup>		---	14.5	28	
$T_f$	Fall Time <sup>2,3</sup>		---	2.1	5	
$C_{iss}$	Input Capacitance	$V_{DS}=25V, V_{GS}=0V, F=1\text{MHz}$	---	492	800	pF
$C_{oss}$	Output Capacitance		---	27	50	
$C_{rss}$	Reverse Transfer Capacitance		---	15	25	
$R_g$	Gate resistance		$V_{GS}=0V, V_{DS}=0V, F=1\text{MHz}$	---	2.8	

**Drain-Source Diode Characteristics and Maximum Ratings**

Symbol	Parameter	Conditions	Min.	Typ.	Max.	Unit
$I_S$	Continuous Source Current	$V_G=V_D=0V$ , Force Current	---	---	4	A
$I_{SM}$	Pulsed Source Current		---	---	8	A
$V_{SD}$	Diode Forward Voltage	$V_{GS}=0V, I_S=1A, T_J=25^\circ\text{C}$	---	---	1	V
$t_{rr}$	Reverse Recovery Time <sup>2</sup>	$I_S=1A, dI/dt=100A/\mu s$	---	---	---	ns
$Q_{rr}$	Reverse Recovery Charge <sup>2</sup>	$T_J=25^\circ\text{C}$	---	---	---	nC

**Note :**

1. Repetitive Rating : Pulsed width limited by maximum junction temperature.
2. The data tested by pulsed, pulse width  $\leq 300\mu s$ , duty cycle  $\leq 2\%$ .
3. Essentially independent of operating temperature.

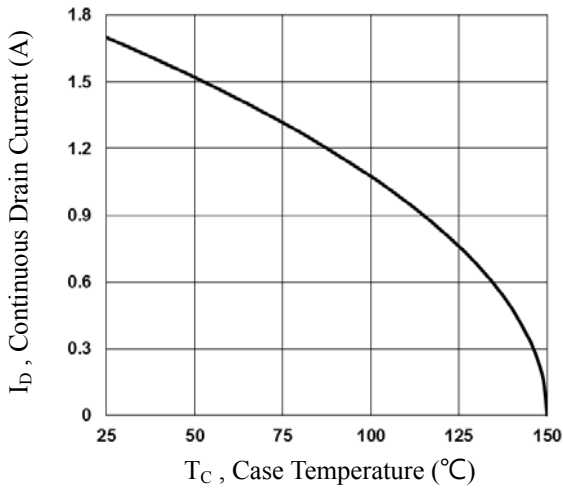

Fig.1 Continuous Drain Current vs.  $T_c$

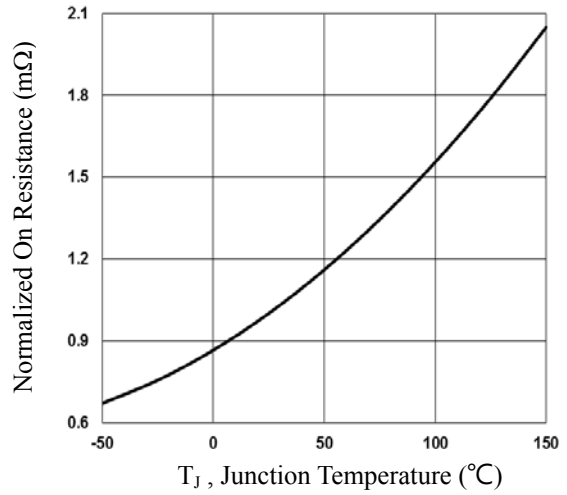

Fig.2 Normalized  $R_{DS(on)}$  vs.  $T_j$

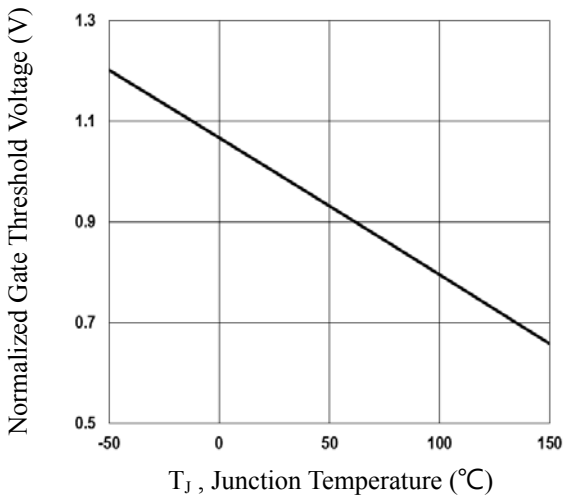

Fig.3 Normalized  $V_{th}$  vs.  $T_j$

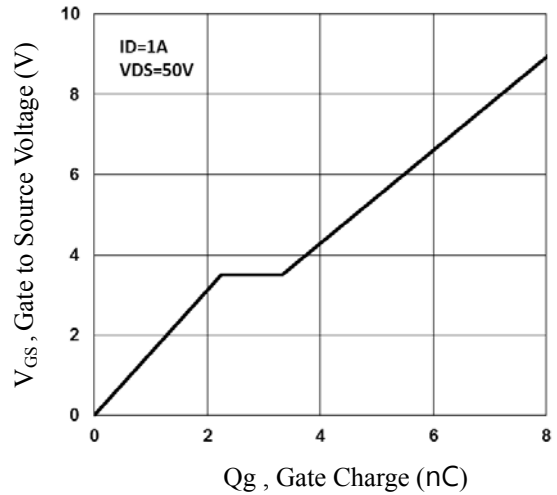

Fig.4 Gate Charge Waveform

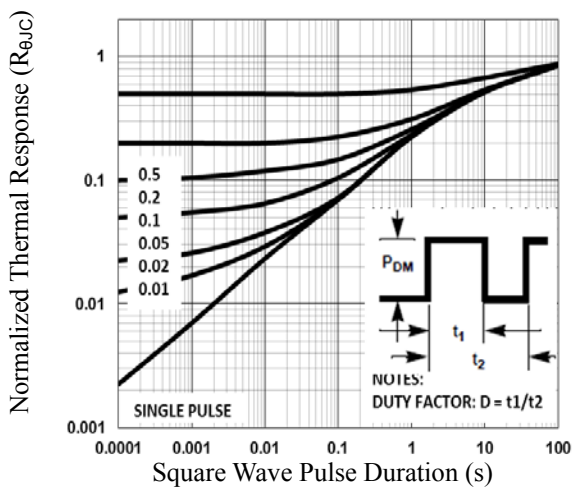

Fig.5 Normalized Transient Impedance

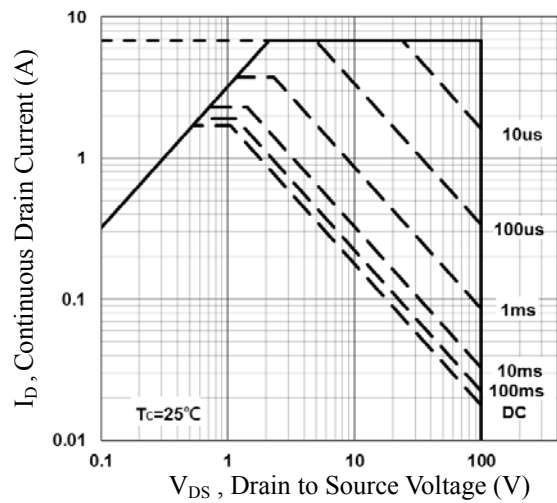

Fig.6 Maximum Safe Operation Area

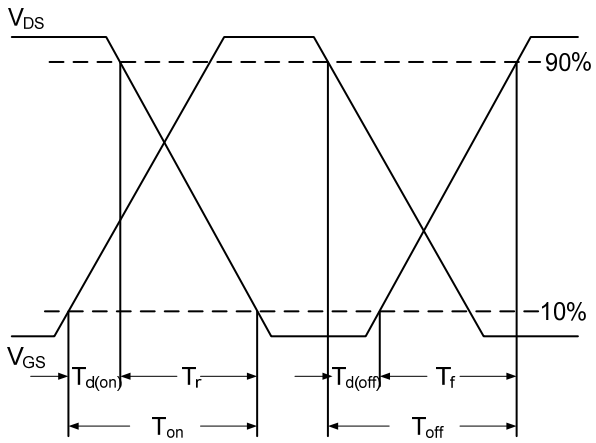

Fig.7 Switching Time Waveform

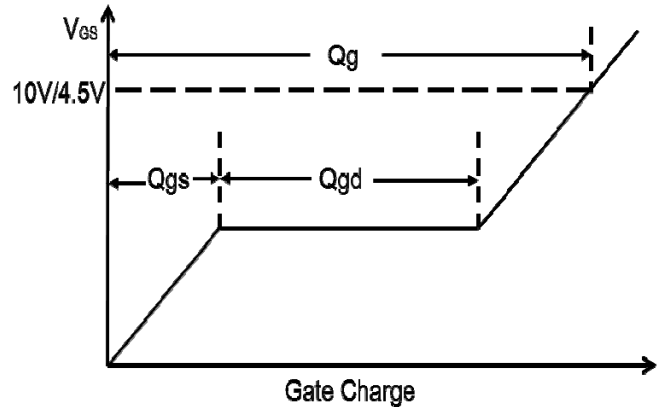
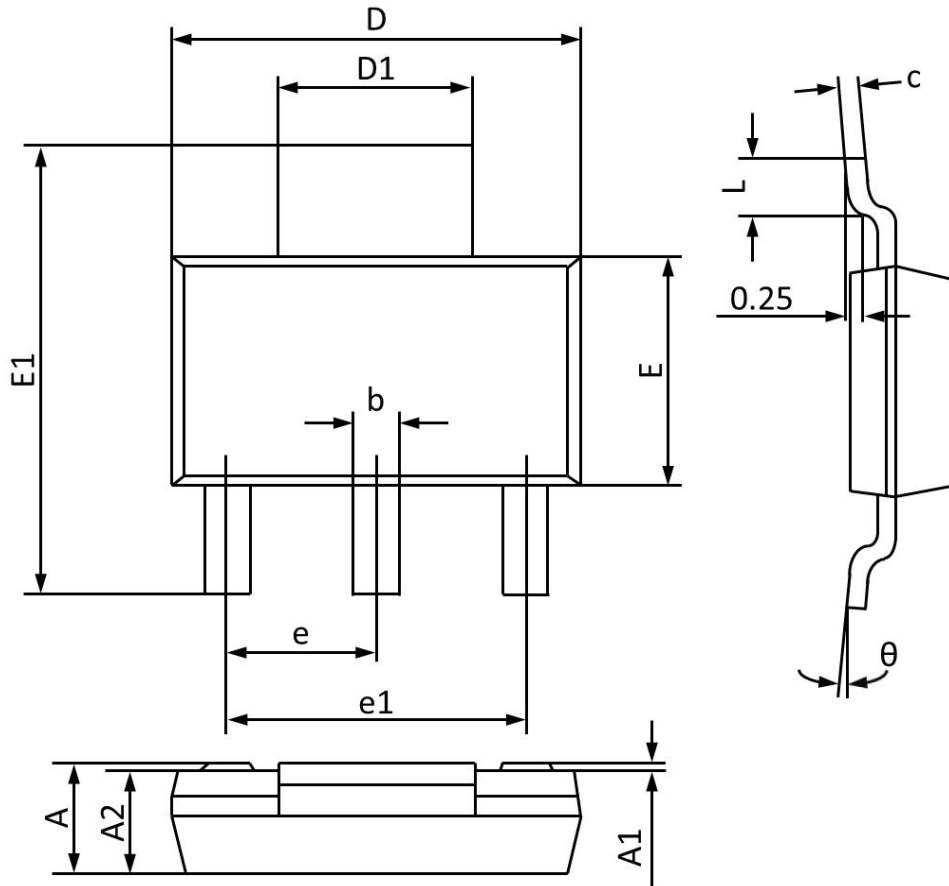

Fig.8 Gate Charge Waveform

### SOT223 PACKAGE INFORMATION



Symbol	Dimensions In Millimeters		Dimensions In Inches	
	Min	Max	Min	Max
A	1.520	1.800	0.060	0.071
A1	0.000	0.100	0.000	0.004
A2	1.500	1.700	0.059	0.067
b	0.660	0.820	0.026	0.032
c	0.250	0.350	0.010	0.014
D	6.200	6.400	0.244	0.252
D1	2.900	3.100	0.114	0.122
E	3.300	3.700	0.130	0.146
E1	6.830	7.070	0.269	0.278
e	2.300 (BSC)		0.091 (BSC)	
e1	4.500	4.700	0.177	0.185
L	0.900	1.150	0.035	0.045
θ	0°	10°	0°	10°