

General Description

These N+P dual Channel enhancement mode power field effect transistors are using trench DMOS technology. This advanced technology has been especially tailored to minimize on-state resistance, provide superior switching performance, and withstand high energy pulse in the avalanche and commutation mode. These devices are well suited for high efficiency fast switching applications.

PPAK5x6 Dual Pin Configuration

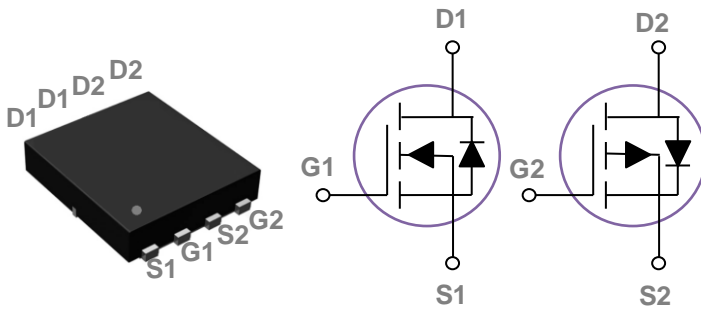

BVDSS	RDSON	ID
60V	40mΩ	18A
-60V	96mΩ	-11A

Features

- Fast switching
- Green Device Available
- Suit for 4.5V Gate Drive Applications

Applications

- DC Fan
- Motor Drive Applications
- Networking
- Half / Full Bridge Topology

Absolute Maximum Ratings $T_c=25^\circ\text{C}$ unless otherwise noted

Symbol	Parameter	Rating		Units
V_{DS}	Drain-Source Voltage	60	-60	V
V_{GS}	Gate-Source Voltage	± 20	± 20	V
I_D	Drain Current – Continuous ($T_c=25^\circ\text{C}$)	18	-11	A
	Drain Current – Continuous ($T_c=100^\circ\text{C}$)	11	-7	A
I_{DM}	Drain Current – Pulsed ¹	72	-44	A
P_D	Power Dissipation ($T_c=25^\circ\text{C}$)	29		W
	Power Dissipation – Derate above 25°C	0.23		W/ $^\circ\text{C}$
T_{STG}	Storage Temperature Range	-55 to 150		$^\circ\text{C}$
T_J	Operating Junction Temperature Range	-55 to 150		$^\circ\text{C}$

Thermal Characteristics

Symbol	Parameter	Typ.	Max.	Unit
$R_{\theta JA}$	Thermal Resistance Junction to ambient	---	62.5	$^\circ\text{C}/\text{W}$
$R_{\theta JC}$	Thermal Resistance Junction to Case	---	4.4	$^\circ\text{C}/\text{W}$

N-CH Electrical Characteristics (T_J=25 °C, unless otherwise)
Off Characteristics

Symbol	Parameter	Conditions	Min.	Typ.	Max.	Unit
BV _{DSS}	Drain-Source Breakdown Voltage	V _{GS} =0V , I _D =250uA	60	---	---	V
I _{DSS}	Drain-Source Leakage Current	V _{DS} =60V , V _{GS} =0V , T _J =25°C	---	---	1	uA
		V _{DS} =48V , V _{GS} =0V , T _J =125°C	---	---	10	uA
I _{GSS}	Gate-Source Leakage Current	V _{GS} =±20V , V _{DS} =0V	---	---	±100	nA

On Characteristics

R _{DS(ON)}	Static Drain-Source On-Resistance	V _{GS} =10V , I _D =6A	---	33	40	mΩ
		V _{GS} =4.5V , I _D =3A	---	38	49	mΩ
V _{GS(th)}	Gate Threshold Voltage	V _{GS} =V _{DS} , I _D =250uA	1.2	1.6	2.5	V
g _{fs}	Forward Transconductance	V _{DS} =10V , I _D =3A	---	6	---	S

Dynamic and switching Characteristics

Q _g	Total Gate Charge ^{2,3}	V _{DS} =30V , V _{GS} =10V , I _D =10A	---	8.5	15	nC
Q _{gs}	Gate-Source Charge ^{2,3}		---	1.5	4	
Q _{gd}	Gate-Drain Charge ^{2,3}		---	2.4	5	
T _{d(on)}	Turn-On Delay Time ^{2,3}	V _{DD} =30V , V _{GS} =10V , R _G =6Ω I _D =10A	---	3	5	ns
T _r	Rise Time ^{2,3}		---	7	11	
T _{d(off)}	Turn-Off Delay Time ^{2,3}		---	16	25	
T _f	Fall Time ^{2,3}		---	5	8	
C _{iss}	Input Capacitance	V _{DS} =30V , V _{GS} =0V , F=1MHz	---	580	900	pF
C _{oss}	Output Capacitance		---	40	60	
C _{rss}	Reverse Transfer Capacitance		---	30	45	
R _g	Gate resistance	V _{GS} =0V , V _{DS} =0V , F=1MHz	---	2.6	---	Ω

Drain-Source Diode Characteristics and Maximum Ratings

Symbol	Parameter	Conditions	Min.	Typ.	Max.	Unit
I _S	Continuous Source Current	V _G =V _D =0V , Force Current	---	---	18	A
I _{SM}	Pulsed Source Current		---	---	36	A
V _{SD}	Diode Forward Voltage	V _{GS} =0V , I _S =1A , T _J =25°C	---	---	1	V
t _{rr}	Reverse Recovery Time	V _R =50V , I _S =10A	---	25	---	ns
Q _{rr}	Reverse Recovery Charge	di/dt=100A/μs , T _J =25°C	---	15	---	nC

Note :

1. Repetitive Rating : Pulsed width limited by maximum junction temperature.
2. The data tested by pulsed , pulse width ≤ 300us , duty cycle ≤ 2%.
3. Essentially independent of operating temperature.

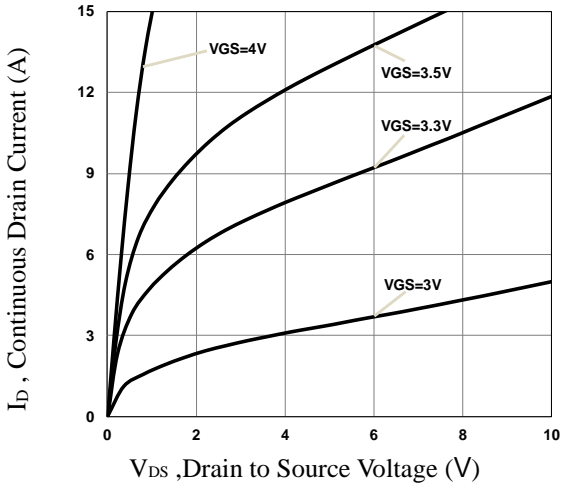

Fig.1 Typical Output Characteristics

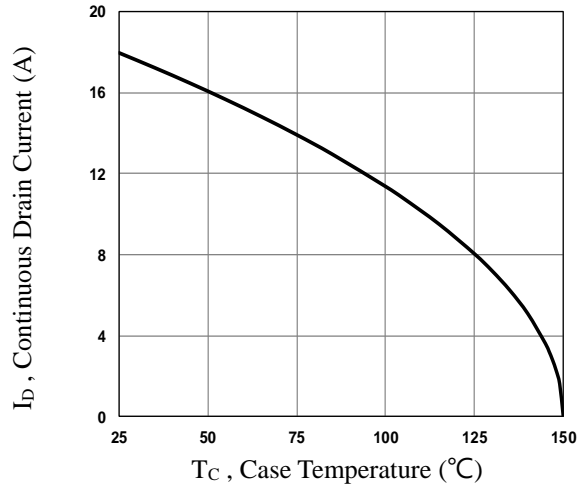

Fig.2 Continuous Drain Current vs. T_c

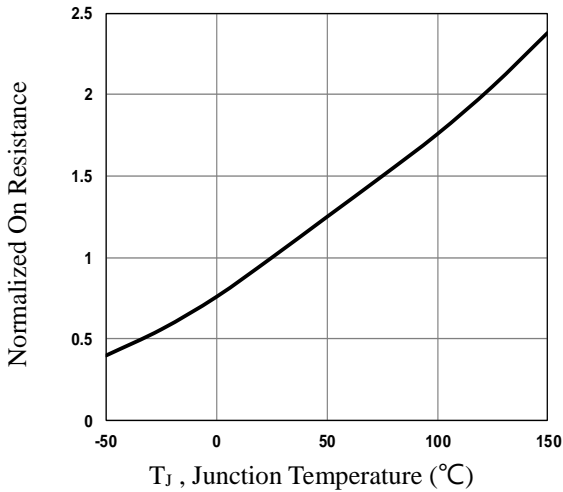

Fig.3 Normalized R_{DS(on)} vs. T_j

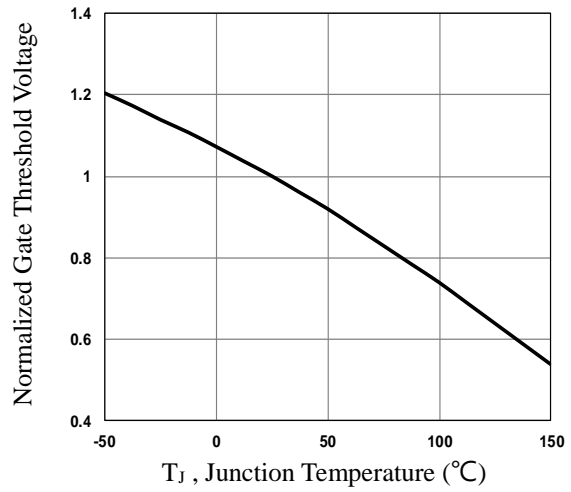

Fig.4 Normalized V_{th} vs. T_j

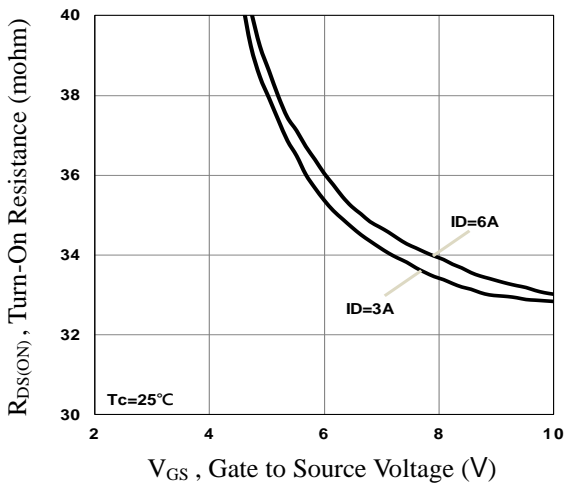

Fig.5 Turn-On Resistance vs. V_{GS}

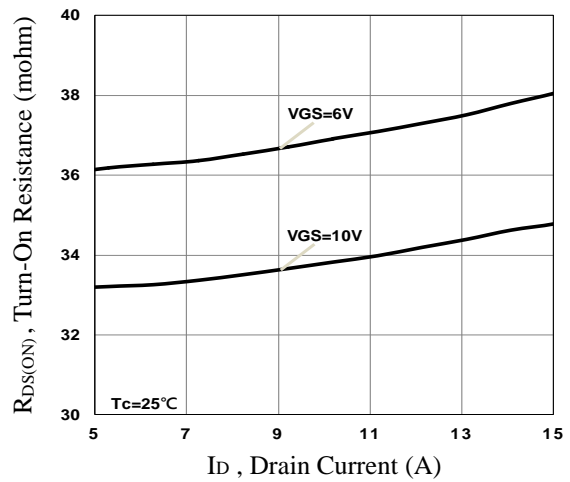

Fig.6 Turn-On Resistance vs. I_D

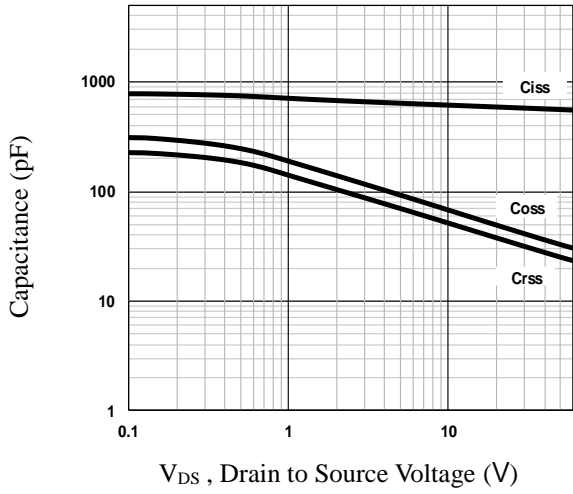

Fig.7 Capacitance Characteristics

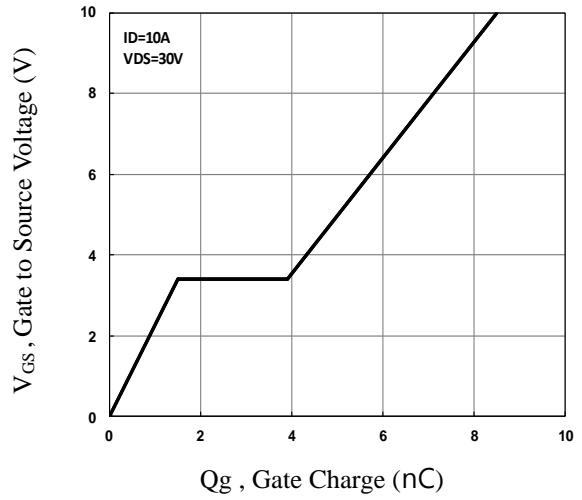

Fig.8 Gate Charge Characteristics

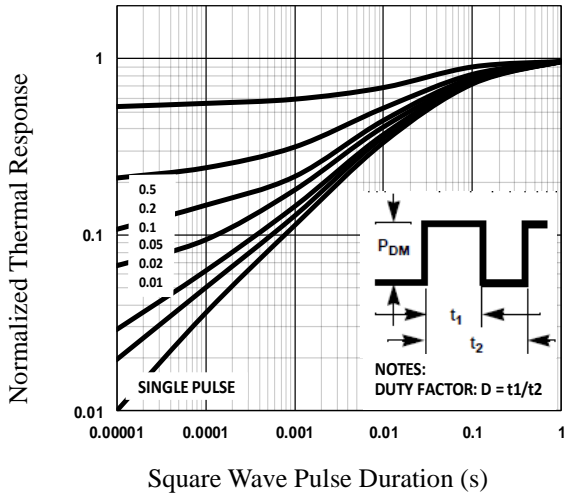

Fig.9 Normalized Transient Impedance

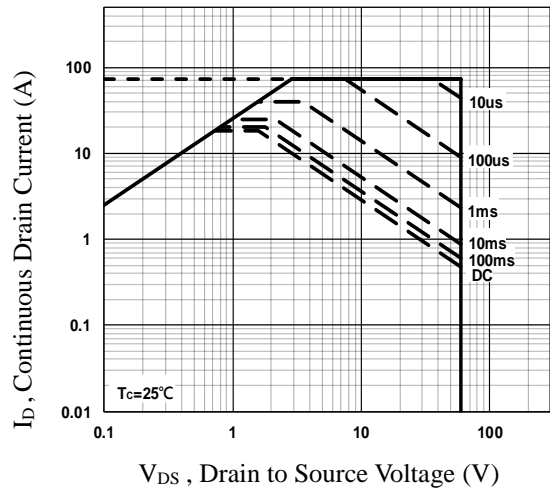

Fig.10 Maximum Safe Operation Area

P-CH Electrical Characteristics (T_J=25 °C, unless otherwise)
Off Characteristics

Symbol	Parameter	Conditions	Min.	Typ.	Max.	Unit
BV _{DSS}	Drain-Source Breakdown Voltage	V _{GS} =0V, I _D =-250uA	-60	---	---	V
I _{DSS}	Drain-Source Leakage Current	V _{DS} =-60V, V _{GS} =0V, T _J =25°C	---	---	-1	uA
		V _{DS} =-48V, V _{GS} =0V, T _J =125°C	---	---	-10	uA
I _{GSS}	Gate-Source Leakage Current	V _{GS} =±20V, V _{DS} =0V	---	---	±100	nA

On Characteristics

R _{DS(ON)}	Static Drain-Source On-Resistance	V _{GS} =-10V, I _D =-4A	---	80	96	mΩ
		V _{GS} =-4.5V, I _D =-2A	---	102	133	mΩ
V _{GS(th)}	Gate Threshold Voltage	V _{GS} =V _{DS} , I _D =-250uA	-1.0	-1.6	-2.5	V
g _{fs}	Forward Transconductance	V _{DS} =-10V, I _D =-3A	---	5.5	---	S

Dynamic and switching Characteristics

Q _g	Total Gate Charge ^{4,5}	V _{DS} =-30V, V _{GS} =-10V, I _D =-5A	---	10	15	nC
Q _{gs}	Gate-Source Charge ^{4,5}		---	1.6	3	
Q _{gd}	Gate-Drain Charge ^{4,5}		---	3	5	
T _{d(on)}	Turn-On Delay Time ^{4,5}	V _{DD} =-30V, V _{GS} =-10V, R _G =6Ω I _D =-5A	---	10	15	ns
T _r	Rise Time ^{4,5}		---	15	25	
T _{d(off)}	Turn-Off Delay Time ^{4,5}		---	40	60	
T _f	Fall Time ^{4,5}		---	10	15	
C _{iss}	Input Capacitance	V _{DS} =-30V, V _{GS} =0V, F=1MHz	---	710	1070	pF
C _{oss}	Output Capacitance		---	40	60	
C _{rss}	Reverse Transfer Capacitance		---	30	45	
R _g	Gate resistance	V _{GS} =0V, V _{DS} =0V, F=1MHz	---	24	---	Ω

Drain-Source Diode Characteristics and Maximum Ratings

Symbol	Parameter	Conditions	Min.	Typ.	Max.	Unit
I _S	Continuous Source Current	V _G =V _D =0V, Force Current	---	---	-11	A
I _{SM}	Pulsed Source Current		---	---	-22	A
V _{SD}	Diode Forward Voltage	V _{GS} =0V, I _S =-1A, T _J =25°C	---	---	-1	V
t _{rr}	Reverse Recovery Time	V _R =-50V, I _S =-10A	---	20	---	ns
Q _{rr}	Reverse Recovery Charge	di/dt=100A/μs, T _J =25°C	---	15	---	nC

Note :

4. The data tested by pulsed, pulse width ≤ 300us, duty cycle ≤ 2%.
5. Essentially independent of operating temperature.

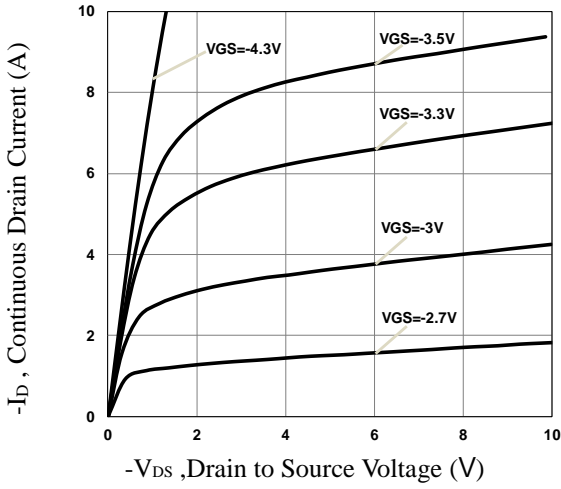

Fig.11 Typical Output Characteristics

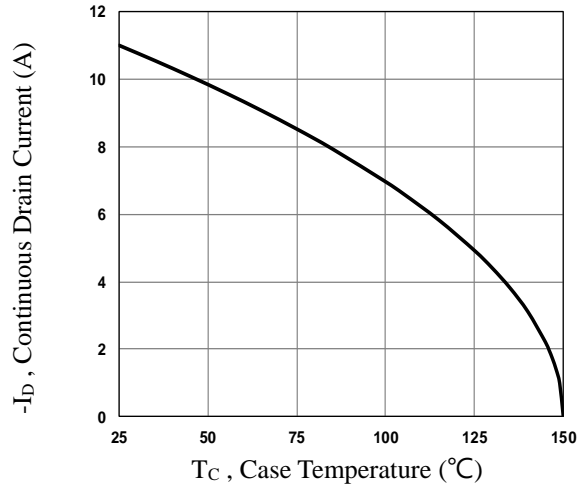

Fig.12 Continuous Drain Current vs. T_c

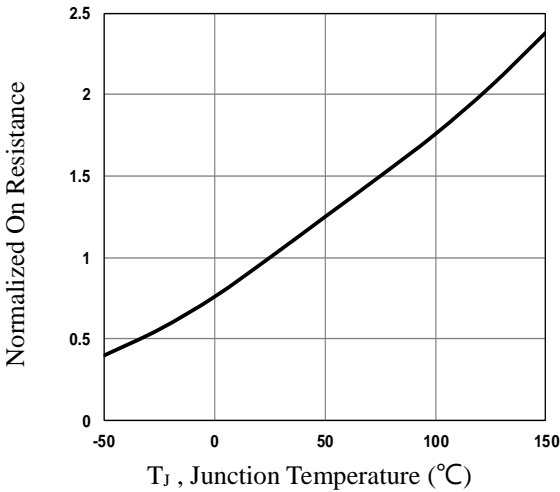

Fig.13 Normalized R_{DS(on)} vs. T_j

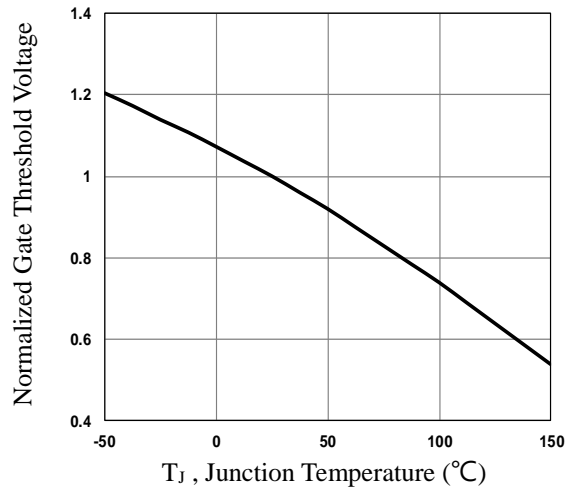

Fig.14 Normalized V_{th} vs. T_j

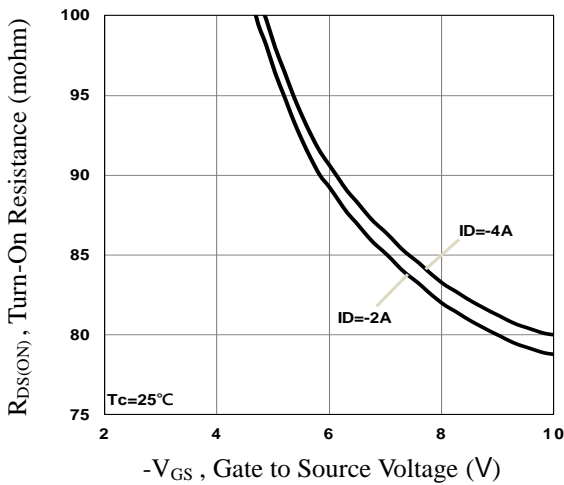

Fig.15 Turn-On Resistance vs. V_{GS}

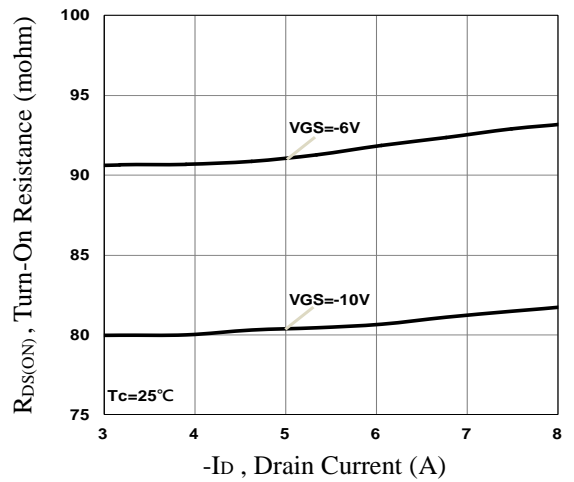

Fig.16 Turn-On Resistance vs. I_D

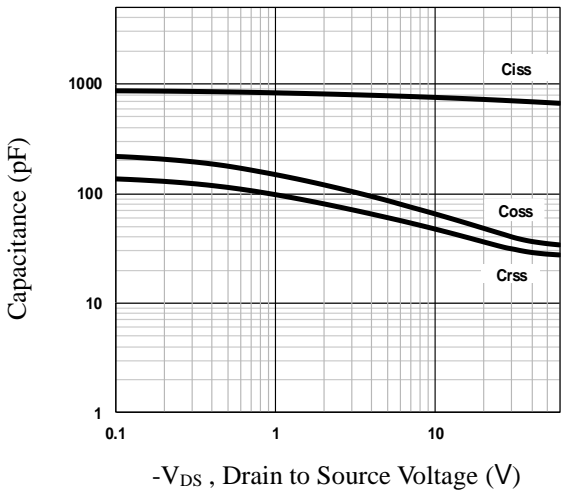

Fig.17 Capacitance Characteristics

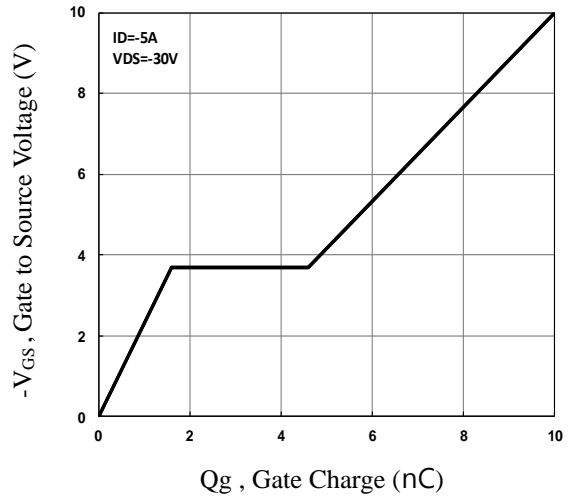

Fig.18 Gate Charge Characteristics

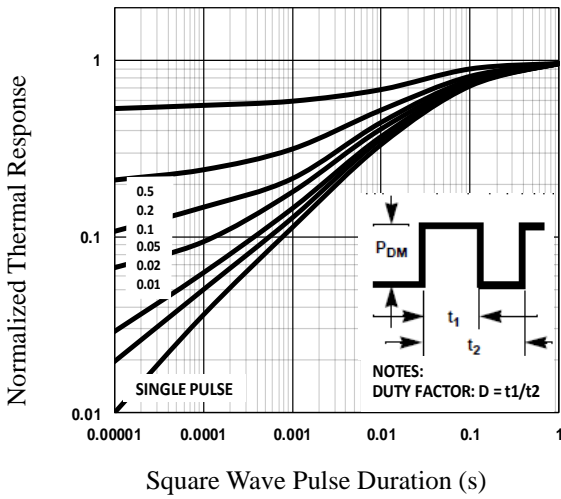

Fig.19 Normalized Transient Impedance

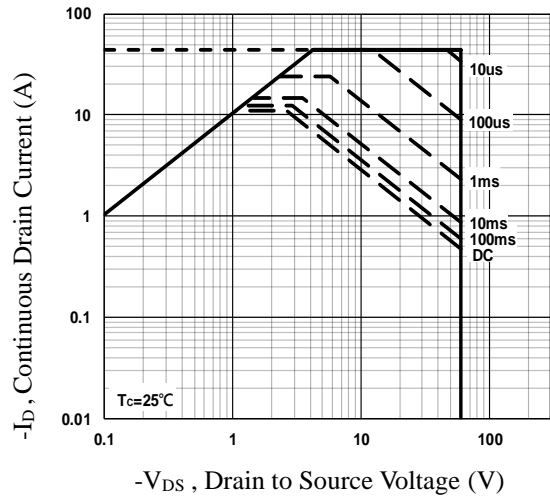

Fig.20 Maximum Safe Operation Area

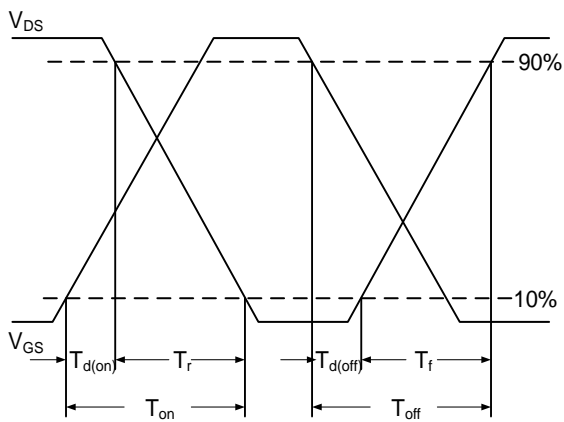

Fig.21 Switching Time Waveform

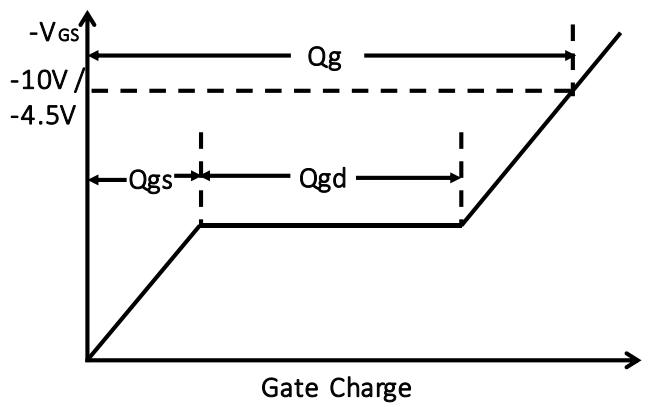
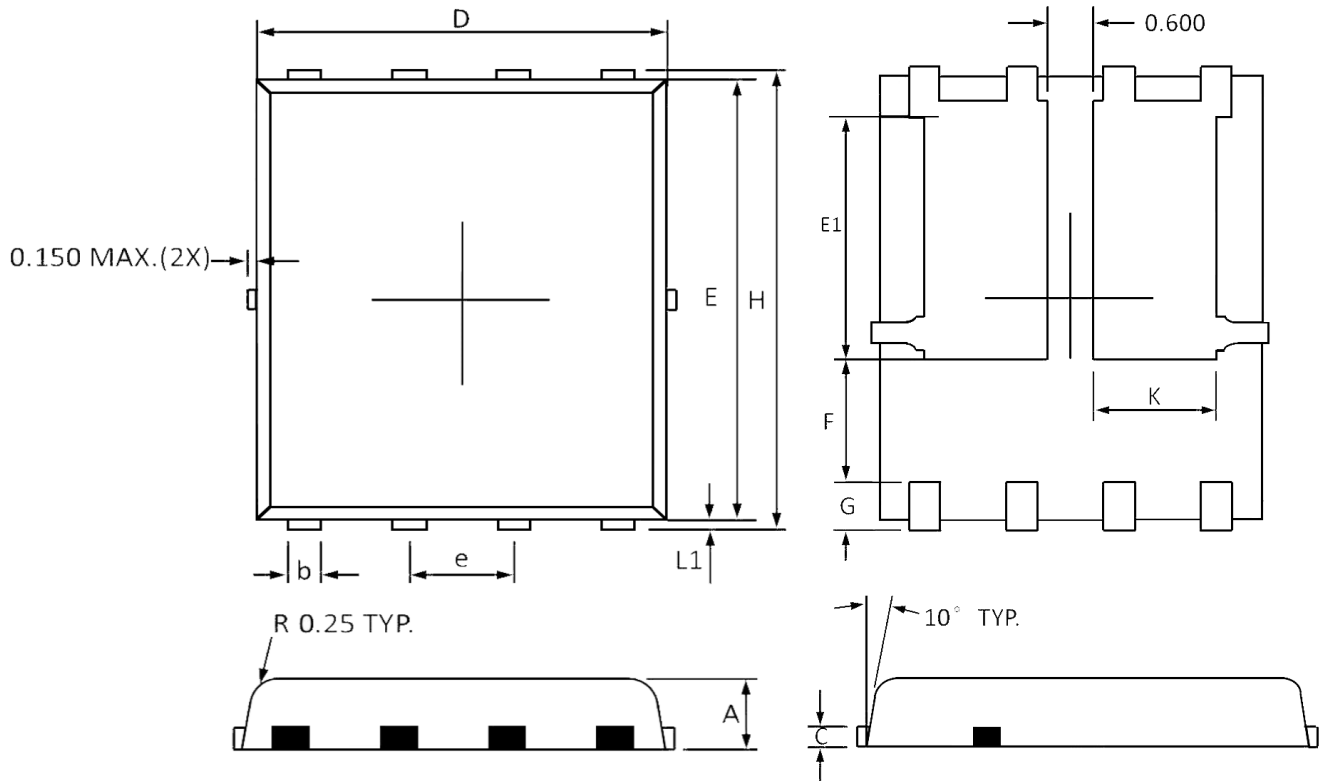

Fig.22 Gate Charge Waveform

PPAK5x6 Dual PACKAGE INFORMATION



Symbol	Dimensions In Millimeters		Dimensions In Inches	
	Min	Max	Min	Max
A	0.800	1.200	0.031	0.047
b	0.300	0.510	0.012	0.020
C	0.250 Ref		0.010 Ref	
D	4.800	5.400	0.189	0.213
E	5.450	5.960	0.215	0.235
E1	3.200	3.800	0.126	0.150
e	1.27 BSC		0.050 BSC	
F	1.000	1.900	0.039	0.075
G	0.380	0.800	0.015	0.031
H	5.850	6.300	0.230	0.248
L1	0.050	0.250	0.002	0.010
K	1.500	1.900	0.059	0.074

PPAK5X6 Dual RECOMMENDED LAND PATTERN

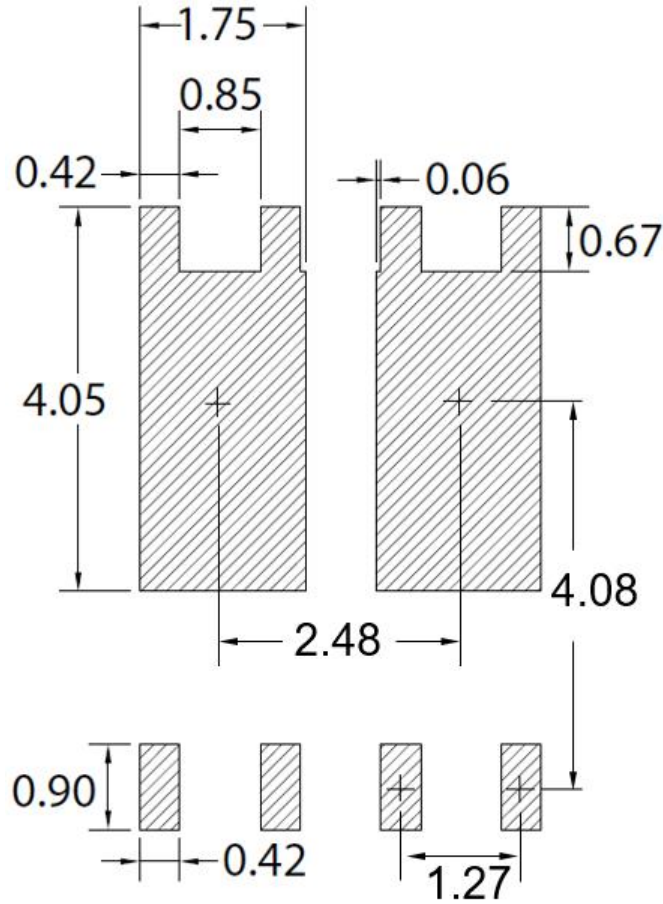

unit : mm