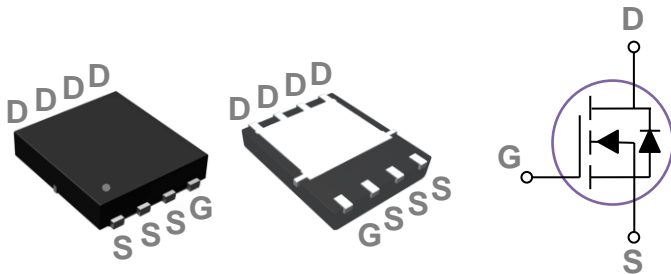


### General Description

These N-Channel enhancement mode power field effect transistors are using trench DMOS technology. This advanced technology has been especially tailored to minimize on-state resistance, provide superior switching performance, and withstand high energy pulse in the avalanche and commutation mode. These devices are well suited for high efficiency fast switching applications.

### PPAK5X6 Pin Configuration



BVDSS	RDSON	ID
100V	6.3mΩ	90A

### Features

- 100V,90A,  $R_{DS(ON)} = 6.3m\Omega @ V_{GS} = 10V$
- Improved  $dv/dt$  capability
- Fast switching
- 100% EAS Guaranteed
- Green Device Available

### Applications

- Networking
- Load Switch
- LED applications
- Quick Charger

### Absolute Maximum Ratings $T_c=25^\circ C$ unless otherwise noted

Symbol	Parameter	Rating	Units
$V_{DS}$	Drain-Source Voltage	100	V
$V_{GS}$	Gate-Source Voltage	$\pm 20$	V
$I_D$	Drain Current – Continuous ( $T_c=25^\circ C$ )	90	A
	Drain Current – Continuous ( $T_c=100^\circ C$ )	57	A
$I_{DM}$	Drain Current – Pulsed <sup>1</sup>	360	A
EAS	Single Pulse Avalanche Energy <sup>2</sup>	245	mJ
IAS	Single Pulse Avalanche Current <sup>2</sup>	70	A
$P_D$	Power Dissipation ( $T_c=25^\circ C$ )	134	W
	Power Dissipation – Derate above $25^\circ C$	1.08	W/ $^\circ C$
$T_{STG}$	Storage Temperature Range	-55 to 150	$^\circ C$
$T_J$	Operating Junction Temperature Range	-55 to 150	$^\circ C$

### Thermal Characteristics

Symbol	Parameter	Typ.	Max.	Unit
$R_{\theta JA}$	Thermal Resistance Junction to ambient	---	62	$^\circ C/W$
$R_{\theta JC}$	Thermal Resistance Junction to Case	---	0.93	$^\circ C/W$

**Electrical Characteristics (T<sub>J</sub>=25 °C, unless otherwise noted)**
**Off Characteristics**

Symbol	Parameter	Conditions	Min.	Typ.	Max.	Unit
BV <sub>DSS</sub>	Drain-Source Breakdown Voltage	V <sub>GS</sub> =0V, I <sub>D</sub> =250μA	100	---	---	V
I <sub>DSS</sub>	Drain-Source Leakage Current	V <sub>DS</sub> =80V, V <sub>GS</sub> =0V, T <sub>J</sub> =25°C	---	---	1	μA
		V <sub>DS</sub> =80V, V <sub>GS</sub> =0V, T <sub>J</sub> =85°C	---	---	10	μA
I <sub>GSS</sub>	Gate-Source Leakage Current	V <sub>GS</sub> =±20V, V <sub>DS</sub> =0V	---	---	±100	nA

**On Characteristics**

R <sub>DS(ON)</sub>	Static Drain-Source On-Resistance	V <sub>GS</sub> =10V, I <sub>D</sub> =15A	---	5.2	6.3	mΩ
V <sub>GS(th)</sub>	Gate Threshold Voltage	V <sub>GS</sub> =V <sub>DS</sub> , I <sub>D</sub> =250μA	2	2.6	4	V
g <sub>fs</sub>	Forward Transconductance	V <sub>DS</sub> =10V, I <sub>D</sub> =3A	---	13	---	S

**Dynamic and switching Characteristics**

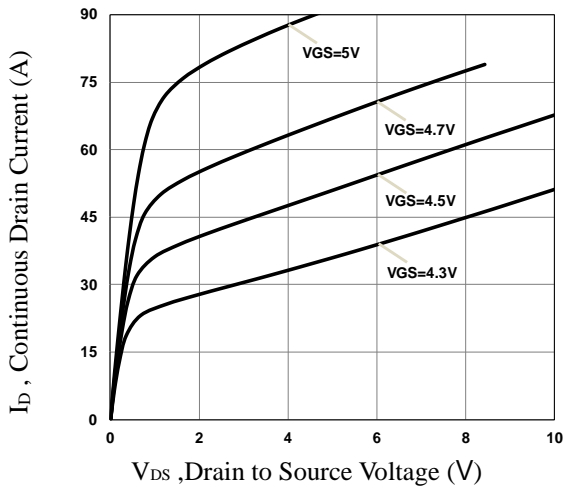
Q <sub>g</sub>	Total Gate Charge <sup>3,4</sup>	V <sub>DS</sub> =50V, V <sub>GS</sub> =10V, I <sub>D</sub> =45A	---	31	47	nC
Q <sub>gs</sub>	Gate-Source Charge <sup>3,4</sup>		---	7.7	12	
Q <sub>gd</sub>	Gate-Drain Charge <sup>3,4</sup>		---	8.9	14	
T <sub>d(on)</sub>	Turn-On Delay Time <sup>3,4</sup>	V <sub>DD</sub> =50V, V <sub>GS</sub> =10V, R <sub>G</sub> =6Ω I <sub>D</sub> =45A	---	15	23	ns
T <sub>r</sub>	Rise Time <sup>3,4</sup>		---	28	42	
T <sub>d(off)</sub>	Turn-Off Delay Time <sup>3,4</sup>		---	45	68	
T <sub>f</sub>	Fall Time <sup>3,4</sup>		---	32	48	
C <sub>iss</sub>	Input Capacitance	V <sub>DS</sub> =50V, V <sub>GS</sub> =0V, F=1MHz	---	2240	3360	pF
C <sub>oss</sub>	Output Capacitance		---	380	570	
C <sub>rss</sub>	Reverse Transfer Capacitance		---	10	15	
R <sub>g</sub>	Gate resistance	V <sub>GS</sub> =0V, V <sub>DS</sub> =0V, F=1MHz	---	1.5	---	Ω

**Drain-Source Diode Characteristics and Maximum Ratings**

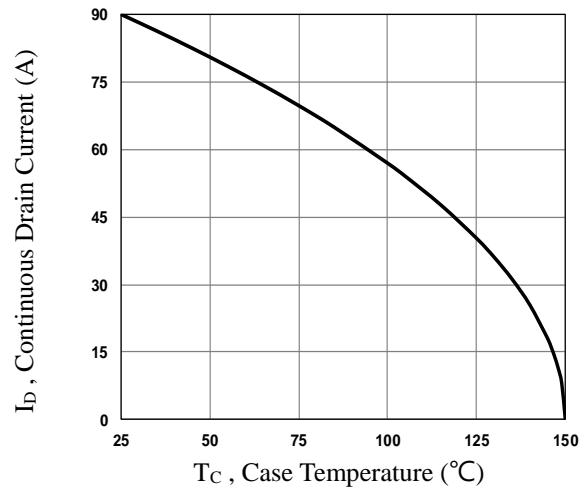
Symbol	Parameter	Conditions	Min.	Typ.	Max.	Unit
I <sub>S</sub>	Continuous Source Current	V <sub>G</sub> =V <sub>D</sub> =0V, Force Current	---	---	90	A
I <sub>SM</sub>	Pulsed Source Current		---	---	180	A
V <sub>SD</sub>	Diode Forward Voltage	V <sub>GS</sub> =0V, I <sub>S</sub> =1A, T <sub>J</sub> =25°C	---	---	1	V
t <sub>rr</sub>	Reverse Recovery Time	V <sub>R</sub> =100V, I <sub>R</sub> =10A	---	210	---	nS
Q <sub>rr</sub>	Reverse Recovery Charge	di/dt=100A/μs, T <sub>J</sub> =25°C	---	400	---	nC

Note :

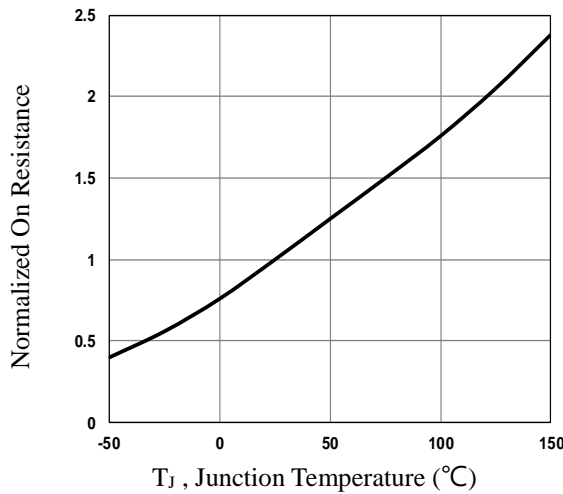
1. Repetitive Rating : Pulsed width limited by maximum junction temperature.
2. V<sub>DD</sub>=50V, V<sub>GS</sub>=10V, L=0.1mH, I<sub>AS</sub>=70A., R<sub>G</sub>=25Ω, Starting T<sub>J</sub>=25°C.
3. The data tested by pulsed, pulse width ≤ 300us, duty cycle ≤ 2%.
4. Essentially independent of operating temperature.



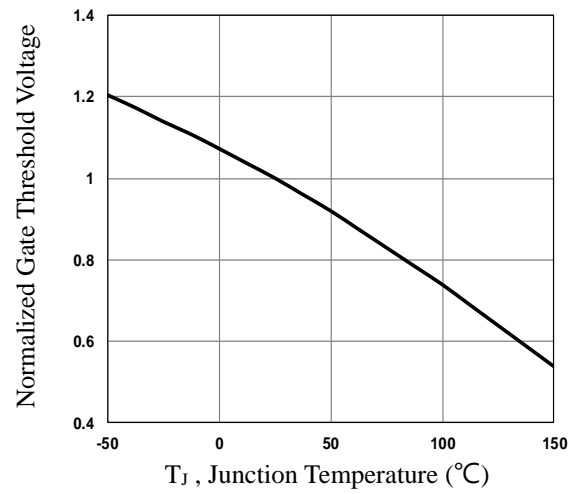
**Fig.1 Typical Output Characteristics**



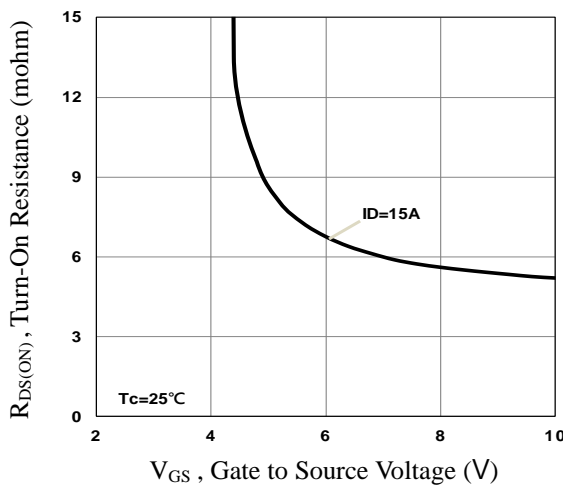
**Fig.2 Continuous Drain Current vs. T<sub>c</sub>**



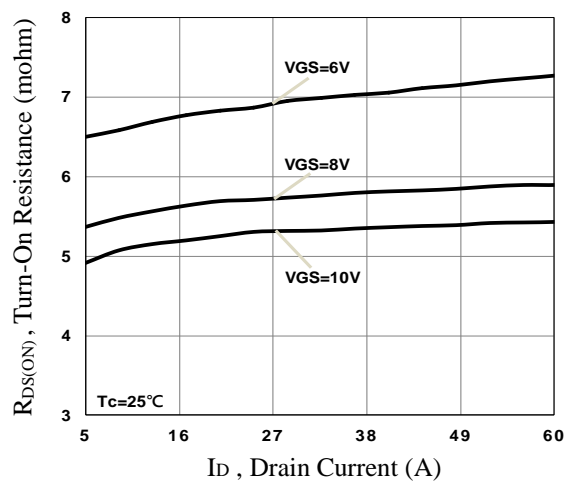
**Fig.3 Normalized R<sub>DS(on)</sub> vs. T<sub>j</sub>**



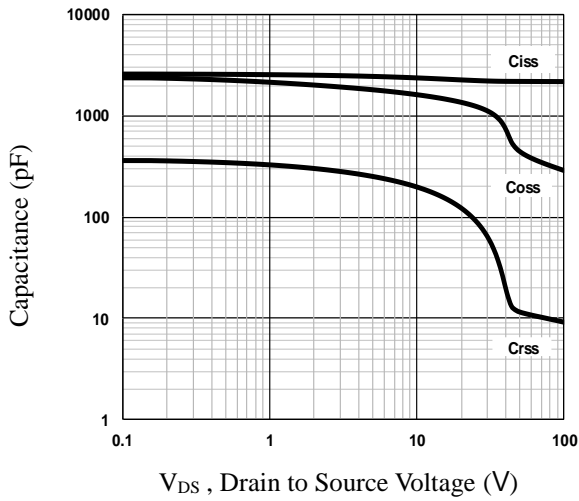
**Fig.4 Normalized V<sub>th</sub> vs. T<sub>j</sub>**



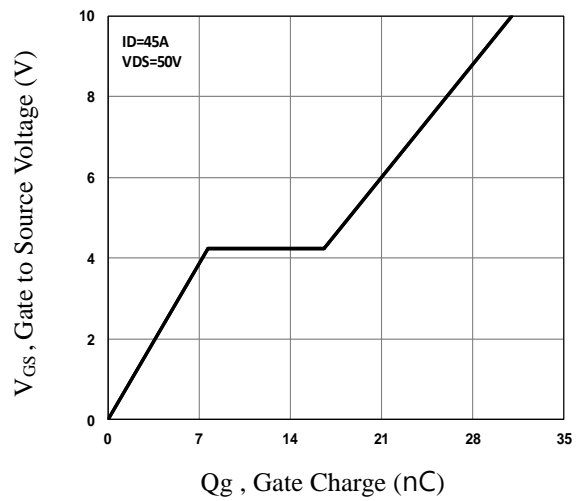
**Fig.5 Turn-On Resistance vs. V<sub>GS</sub>**



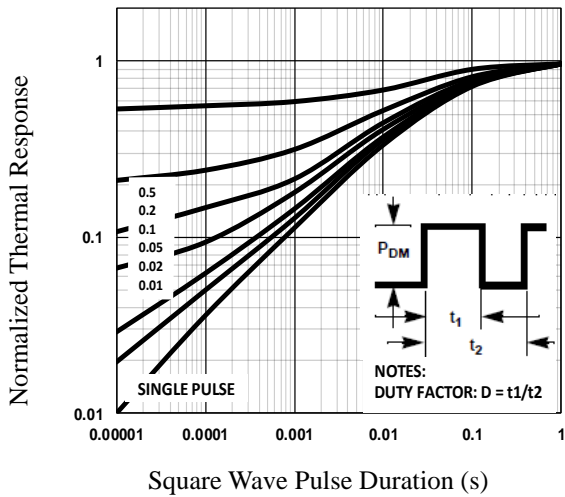
**Fig.6 Turn-On Resistance vs. I<sub>D</sub>**



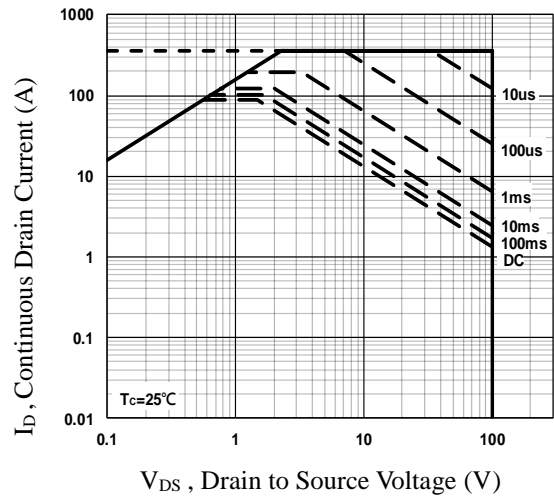
**Fig.7 Capacitance Characteristics**



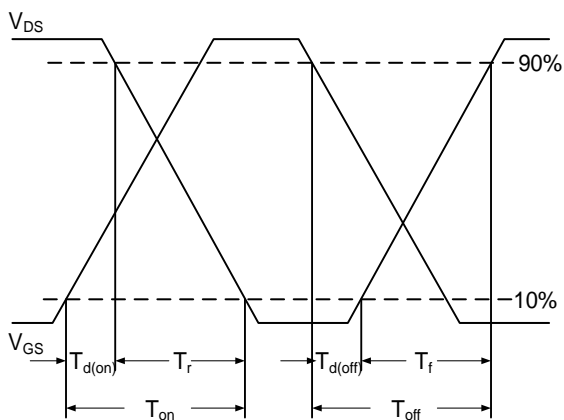
**Fig.8 Gate Charge Characteristics**



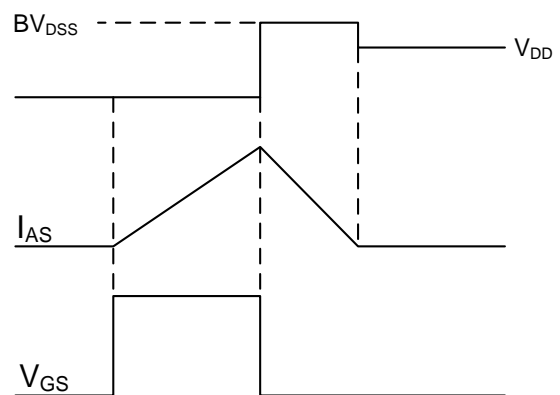
**Fig.9 Normalized Transient Impedance**



**Fig.10 Maximum Safe Operation Area**

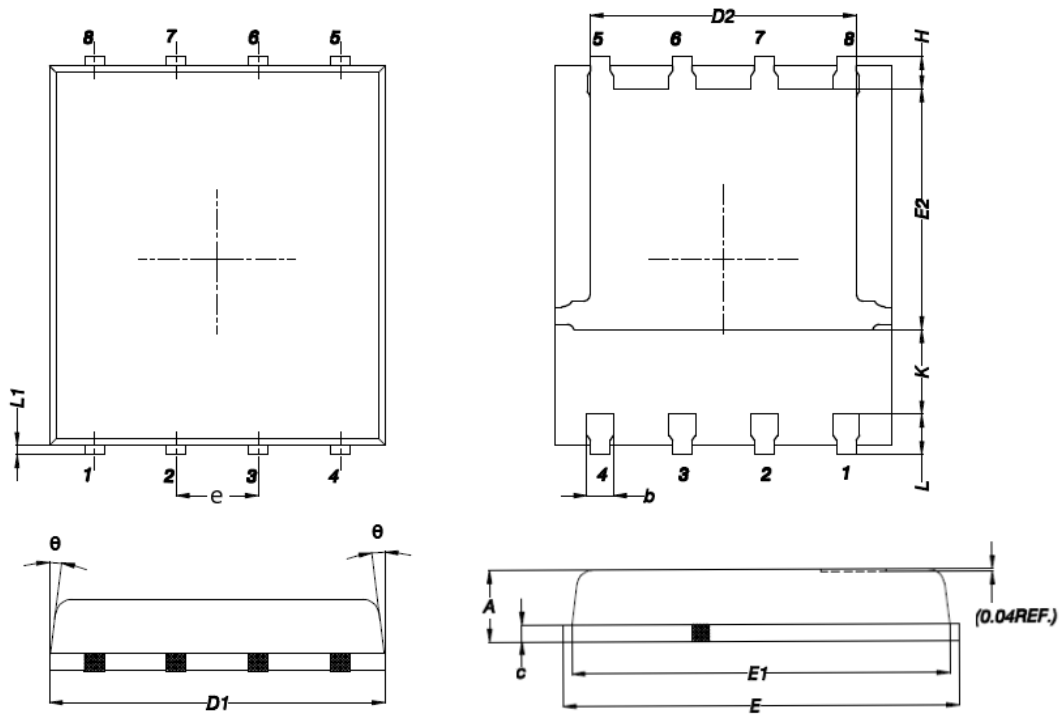


**Fig.11 Switching Time Waveform**



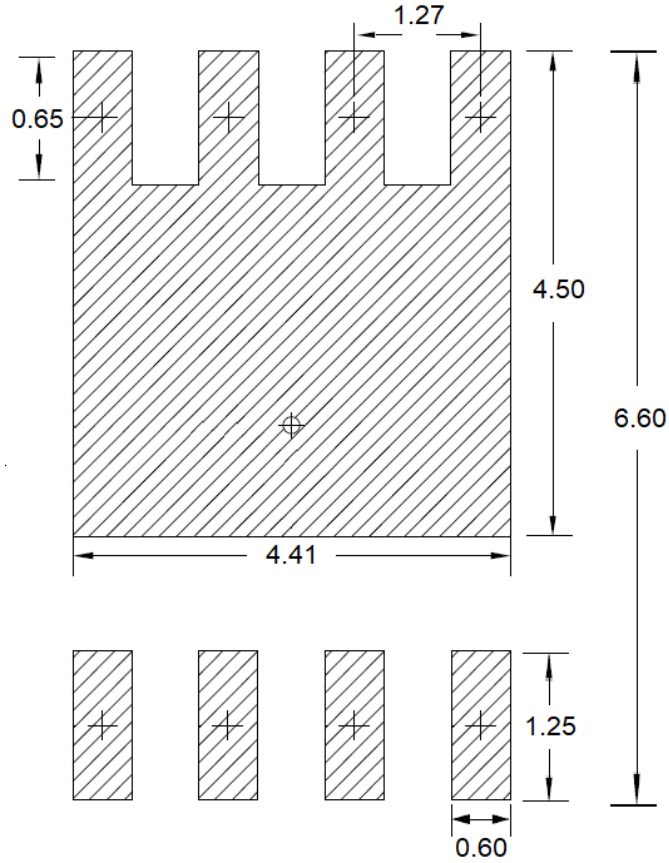
**Fig.12 EAS Waveform**

**PPAK5x6 PACKAGE INFORMATION**



Symbol	Dimensions In Millimeters		Dimensions In Inches	
	MAX	MIN	MAX	MIN
A	1.200	0.850	0.047	0.031
b	0.510	0.300	0.020	0.012
C	0.300	0.200	0.012	0.008
D1	5.400	4.800	0.212	0.189
D2	4.310	3.610	0.170	0.142
E	6.300	5.850	0.248	0.230
E1	5.960	5.450	0.235	0.215
E2	3.920	3.300	0.154	0.130
e	1.27BSC		0.05BSC	
H	0.650	0.380	0.026	0.015
K	---	1.100	---	0.043
L	0.710	0.380	0.028	0.015
L1	0.250	0.050	0.009	0.002
θ	12°	0°	12°	0°

### PPAK5X6 RECOMMENDED LAND PATTERN



unit : mm