



# TDGAR-1083D+-D5GS-M12X-WV

**Industrial EN50155 802.11 ac/g/n 5G Cellular GPS Router with 3x10/100/1000Base-T(X), M12 Connector**

## Features

- Leading **EN50155**-compliant wireless access point for rolling stock application
- Provide HNAT enhance LAN to WAN routing performance
- **Provide SNAT/PAT/1:1 NAT**
- Dual high Speed Air Connectivity: each WLAN interface support **IEEE 802.11 ac/g/n** up to 867Mbps link speed
- Highly Security Capability: WEP/WPA/WPA-PSK(TKIP,AES)/WPA2/WPA2-PSK(TKIP,AES)/802.1X Authentication supported
- Support wireless AP/Client mode
- Provide 3x10/100/1000Base-T(X) Ethernet with M12 x-coding
- **Supports 5G and LTE Modem dial up**
- Support GPS connection
- Secured Management by HTTPS
- Various kind of WAN Connection Type supported: Dynamic/Static IP, PPPoE, Modem Dial Up
- IP table configurable to prevent access from unauthorized IP address
- Support VPN for secured network connection (Open VPN, PPTP VPN)
- 1KV isolation for PoE P.D. port
- Support NAT Setting (Virtual Server, Port Trigger)
- Support DHCP forwarding through PPTP function
- Wireless connecting status monitoring
- Wifi multiple SSID supported
- Event Warning by Syslog, Email, SNMP Trap
- Wall mounting enabled

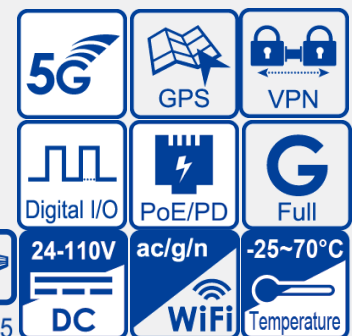

## Introduction

ORing's Transporter™ series cellular router is designed for industrial and rolling stock wireless applications, such as vehicle, and railway applications. TDGAR-1083D+-D5GS-M12X-WV is reliable wifi5 router with 3 ports Gigabit Ethernet which is fully compliant with EN50155 certification. It could be configured to operate in 3 modes of routing function: Dynamic/Static IP route, PPPoE authentication, and Cellular modem dial up. Users can set up WLAN environment to fulfill demands of various applications rapidly by dialing up cellular modem. TDGAR-1083D+-D5GS-M12X-WV EN50155 cellular VPN router use M-series connectors to ensure tight, robust connections, and guarantee reliable operation against environmental disturbances, such as vibration and shock. In addition, TDGAR-1083D+-D5GS-M12X-WV also provides P.D. feature which is fully compliant with IEEE802.3at PoE P.D. specification and TDGAR-1083D+-D5GS-M12X-WV supports GPS function. Therefore, TDGAR-1083D+-D5GS-M12X-WV is one of the most reliable choices for rolling stock applications on the wireless network.

## Dimension



Dimension (Unit =mm)

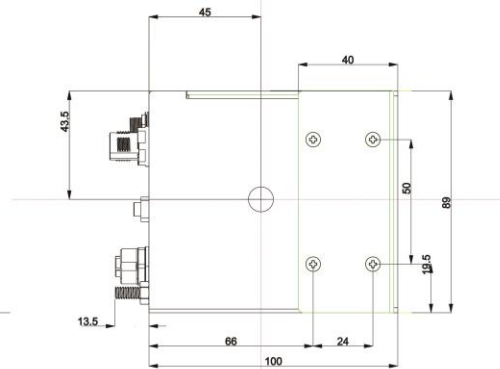
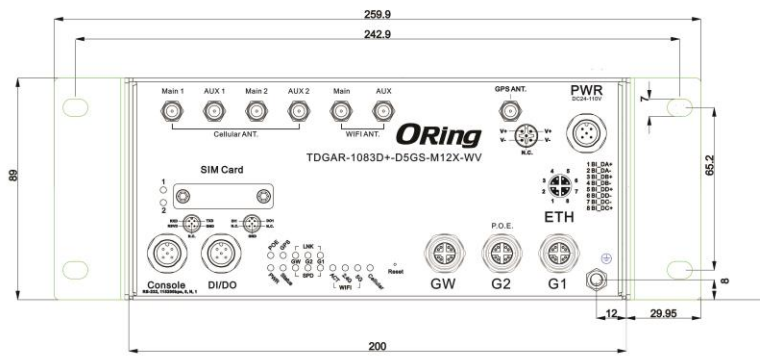
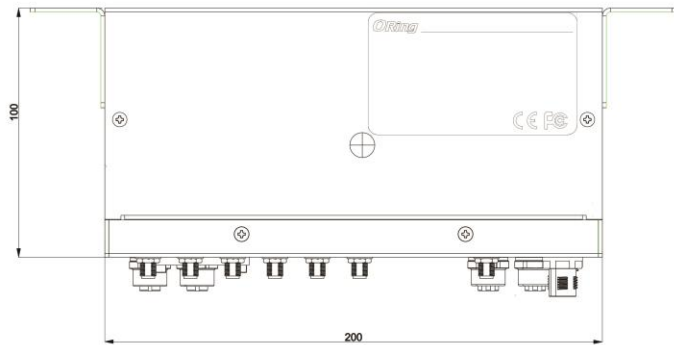
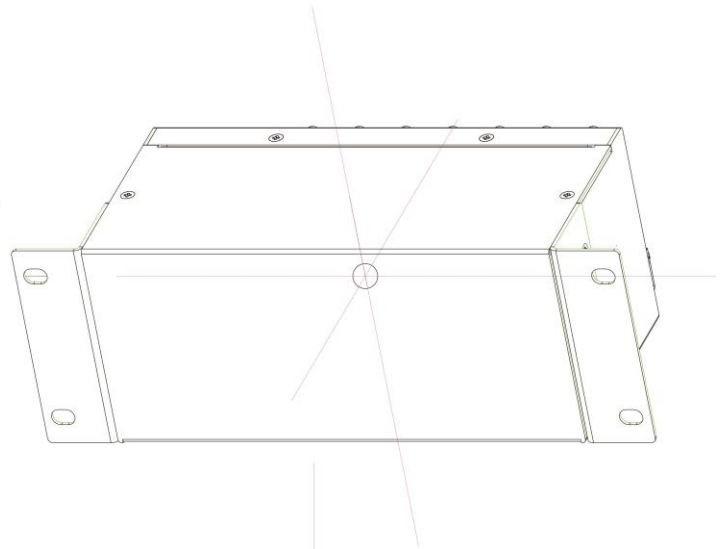

**Pin Definition**

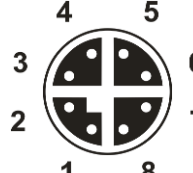
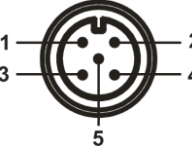
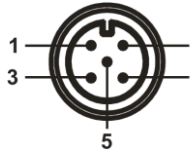
 <p>A-coding Male</p>	PWR M12 port		 <p>X-coding Female</p>	10/100/1000Base-T(X) M12 port	
	Pin No.	Description		Pin No.	Description
	#1	V+		#1	BI_DA+
	#2	V+		#2	BI_DA-
	#3	V-		#3	BI_DB+
#4	V-	#4	BI_DB-		
#5	N.C.	#5	BI_DD+		
 <p>A-coding Female</p>	Console M12 port		 <p>A-coding Female</p>	DI/DO M12 port	
	Pin No.	Description		Pin No.	Description
	#1	RXD		#1	Digital Input
	#2	TXD		#2	Digital Output
	#3	RSVD		#3	N.C.
#4	GND	#4	N.C.		
#5	N.C.	#5	GND		

## Specifications

<b>ORing EN50155 LTE Router Model</b>	<b>TDGAR-1083D+-D5GS-M12X-WV</b>
<b>Physical Ports</b>	
10/100/1000Base-T(X) Ports in M12 (8-pin X-coding female)	<b>1(WAN) + 2(LAN)</b>
Sim Card Slot	<b>2</b>
Console Port in M12 (5-pin A-coding female)	<b>1</b>
DI/DO Port in M12 (5-pin A-coding female)	<b>DI x 1, DO x 1</b> <b>(DI :Logic level 1: 5V~30V, Logic level 0: 0V~2V</b> <b>DO :Maximum Voltage is 30V, Maximum Current is 20mA)</b>
Input Power Port in M12 (5-pin A-coding male)	<b>1</b>
PoE P.D Port	Present at Ethernet (G2) Fully compliant with IEEE 802.3at Power Device specification Over load & short circuit protection Isolation Voltage: 1000 VDC min. Isolation Resistance : 10 <sup>8</sup> ohms min
<b>Antenna connector</b>	
WIFI	2 x RP-SMA female
Cellular	4 x SMA female
GPS	1 x SMA female
<b>GPS Interface</b>	
Receiver Type	50 Channels GPS L1 frequency, C/A Code
Time-To-First-Fix	Cold Start: 29s Warm Start: 29s Hot Start: <1s
Sensitivity	Tracking & Navigation: -160dBm Reacquisition: -160dBm Cold Start: -147dBm
<b>Cellular Interface</b>	
Cellular Standard	HSDPA / HSUPA / LTE/ LTE+/ 5G
Band Option	5G NR : n1,n2,n3,n5,n7,n8,n12,n20,n28,n41,n66,n71,n77,n78,n79 LTE : FDD : B1/B2/B3/B4/B5/B7/B8/B12/B13/B14/B17/B18/B19/B20/B25/B26/B28/B29/B30/B32/B66/B71 TDD : B34/B38/B39/B40/B41/B42/B46/B48 WCDMA : B1/B2/B3/B4/B5/B6/B8/B9/B19
<b>WLAN interface</b>	
Modulation	IEEE 802.11a: OFDM IEEE 802.11b: CCK, DQPSK, DBPSK IEEE 802.11g: OFDM IEEE 802.11n: BPSK, QPSK, 16-QAM, 64-QAM IEEE 802.11ac: BPSK, QPSK, 16-QAM, 64-QAM, 256-QAM
Frequency Band	America / FCC: 2.412~2.462 GHz 5.180~5.240 GHz & 5.745~5.825 GHz Europe CE / ETSI: 2.412~2.472 GHz 5.180~5.240 GHz
Transmission Rate	IEEE 802.11b: 1/2/5.5/11 Mbps IEEE 802.11a/g: 6/9/12/18/24/36/48/54 Mbps IEEE 802.11n: UP to 300 Mbps IEEE 802.11ac: up to 867Mbps
Transmit Power	IEEE 802.11a: 12dBm ± 2dBm@54Mbps

	IEEE 802.11b: 18dBm ± 2dBm@11Mbps IEEE 802.11g: 15dBm ± 2dBm@54Mbps IEEE 802.11gn HT20: 14dBm ± 2dBm @MCS7 IEEE 802.11gn HT40: 14dBm ± 2dBm @MCS7 IEEE 802.11an HT20: 11dBm ± 2dBm @MCS7 IEEE 802.11an HT40: 10dBm ± 2dBm @MCS7 IEEE 802.11ac VHT80: 7dBm ± 2dBm @MCS9
Receiver Sensitivity	IEEE 802.11a : -71dBm ± 2dBm@54Mbps IEEE 802.11b : -86dBm ± 2dBm@11Mbps IEEE 802.11g : -72dBm ± 2dBm@54Mbps IEEE 802.11gn HT20:-68dBm ± 2dBm@MCS7 IEEE 802.11gn HT40:-66dBm ± 2dBm@MCS7 IEEE 802.11an HT20:-68dBm ± 2dBm@MCS7 IEEE 802.11an HT40:-67dBm ± 2dBm@MCS7 IEEE 802.11ac VHT80:-57dBm ± 2dBm@MCS9
Encryption Security	WEP: (64-bit ,128-bit key supported) WPA/WPA2 :802.11i(WEP and AES encryption) WPA-PSK (256-bit key pre-shared key supported) 802.1X Authentication supported TKIP encryption
Wireless Security	SSID broadcast disable
<b>Protocol Support</b>	
Protocol	ARP,BOOTP, DHCP, DNS, HTTP, IP, ICMP, SNTP, TCP, UDP, RADIUS, SNMP, PPPoE, STP (IEEE 802.1D)
<b>LED Indicators</b>	
PWR	1 x LED, Green for DC Power in
POE	1 x LED, Green for POE Power in
Ethernet Port Indicator	6 x LEDs, LNK: Green for port Link/Act. SPD: Green On for 1000/100Base-T(X) link; Green Off for 10Base link
GPS LED	1 x LED, Green on for GPS on, slow blink for connection Act
WLAN(Wifi) LED	3 x LEDs, 1 x LED, Green On: RF on, Blink: data transmitting 1 x LED, Green for WLAN work on 2.4GHz 1 x LED, Green for WLAN work on 5GHz
Cellular LED	1 x LED, Green slow blink for work normal,
SIM LED	2 x LED, Green in used
Status Indicator	1 x LED, Green slow blink for normal, off for system halt
<b>Power</b>	
Input Power	<b>24 ~ 110Vdc</b>
Isolation	DC 2KV/ AC 1.5KV
Power Consumption (Typ.)	25 watts Max.
Overload Current Protection	Present
Reverse Polarity Protection	Present
<b>Physical Characteristic</b>	
Enclosure	IP-30
Dimension (W x D x H)	200(W) x 100(D) x 89(H) mm
Weight (g)	<2Kg
<b>Environmental</b>	
Storage Temperature	-40 to 85°C (-40 to 185°F)
Operating Temperature	-25 to 70°C (-13 to 158°F)
Operating Humidity	5% to 95% Non-condensing
<b>Regulatory Approvals</b>	
EMI	FCC Part 15, CISPR (EN55022) class A, EN50155 (EN50121-3-2, EN55011, EN50121-4)
EMS	EN61000-4-2 (ESD), EN61000-4-3 (RS), EN61000-4-4 (EFT), EN61000-4-5 (Surge), EN61000-4-6 (CS), EN61000-4-8, EN61000-4-11
Shock	IEC60068-2-27, EN61373
Free Fall	IEC60068-2-31

Vibration	IEC60068-2-6, EN61373
Rail Traffic	EN50155
Cooling	EN60068-2-1
Dry Heat	EN60068-2-2
Safety	EN60950-1
<b>Warranty</b>	5 years

## Ordering Information

	Model Name	Description
Available Model	TDGAR-1083D+-D5GS-M12X-WV_EU	Industrial EN50155 802.11 ac/g/n 5G Cellular GPS Router with 3x10/100/1000Base-T(X), 1-port PoE P.D, M12 Connector, US band
	TDGAR-1083D+-D5GS-M12X-WV_US	Industrial EN50155 802.11 ac/g/n 5G Cellular GPS Router with 3x10/100/1000Base-T(X), 1-port PoE P.D, M12 Connector, EU band

## Packing List

- TDGAR-1083D+-D5GS-M12X-WV x 1
- CD QRcode x 1
- Quick Installation Guide x 1
- Wall-Mount Kit x 2