

DETAILS

Product Number	CA12838_FLARE-MINI-A-PIN
Family	Flare
Type	Assembly
Color	clear
Diameter	16 mm
Height	9,1 mm
Style	round
Optic Material	PMMA
Holder Material	
Fastening	tape, pin
Status	production ready
ROHS Compliant	Yes
Date Updated	2/12/2016

OPTICAL PROPERTIES

LED	Viewing	Light	Effi-	cd/lm	Connector
	Angle	Beam	ciency		
XP-E	113+20 deg	REC-class	94 %	0.900	-
XB-D	130+21 deg	REC-class	94 %	0.800	-
XT-E	124+22 deg	REC-class	94 %	0.700	-
XP-G	114+22 deg	REC-class	94 %	0.800	-
XP-G2	94+19 deg	REC-class	94 %	1.300	-
XP-E2	93+14 deg	REC-class	94 %	1.800	-
XP-L	113+25 deg	REC-class	90 %	0.790	-
XP-L2	100+28 deg	REC-class	94 %	0.840	-
H35C1 (LEMWA33)	96+18 deg	REC-class	94 %	1.320	-
LUXEON Rebel ES	110+19 deg	REC-class	94 %	0.900	-
LUXEON T	95+19 deg	REC-class	93 %	1.300	-
LUXEON H50-2	sim: 18+86	REC-class	sim: 93 %	sim: 1.450	-
LUXEON TX	93+19 deg	REC-class	94 %	1.300	-
LUXEON C	sim: 11+84	REC-class	sim: 92 %	sim: 1.600	-
NCSxx19A	112+20 deg	REC-class	94 %	0.900	-
NCSxx19B	95+15 deg	REC-class	94 %	1.600	-
NVSxx19B/NVSxx19C	101+20 deg	REC-class	94 %	1.200	-
Oslon Square PC	116+22 deg	REC-class	94 %	0.800	-
Oslon SSL 80	84+12 deg	REC-class	93 %	2.000	-
Oslon SSL 150	106+11 deg	REC-class	93 %	1.700	-
LH351Z	95+19 deg	REC-class	94 %	1.500	-



D

C

B

A

4

4

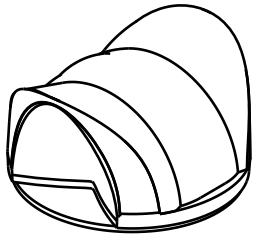

Led center position

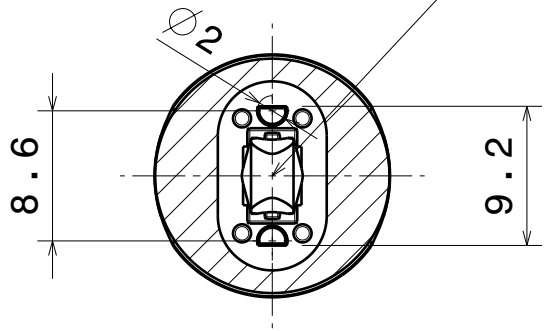

Beam direction

3

3

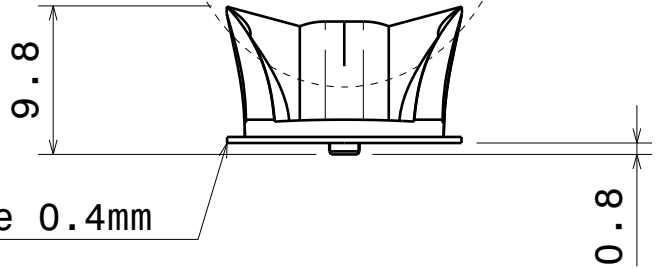
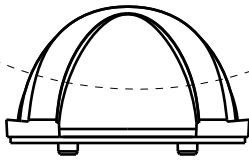
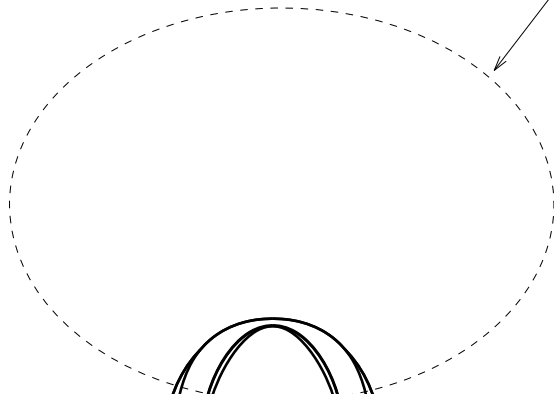

Tape 0.4mm

0.8

2

2

Material:
Lens: PMMA
Tape: PU Foam

Tolerances for dimensions:
0-20mm tolerance value +/-0.1mm
21-45mm tolerance value +/-0.2mm
46-90mm tolerance value +/-0.3mm
91-100mm tolerance value +/-0.4mm
101-mm tolerance value +/-0.5mm

Note:
Must use external positioning
over light source.

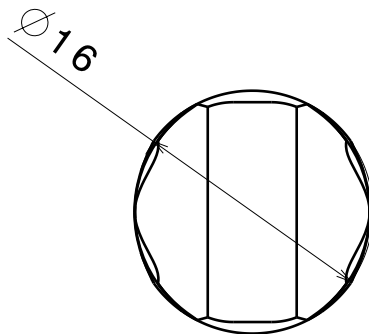

This drawing is our property.
It can't be reproduced
or communicated without
our written agreement.



Ledil Oy
Salorankatu 10
FIN 24240 SALO
Finland

DRAWING TITLE

Datasheet Flare-Mini-A-PIN Assy

DRAWN BY

jk

DATE

20151005

CHECKED BY

DATE

SIZE

A4

DRAWING NUMBER

CA12838

REV

DESIGNED BY

pl

DATE

27.02.2012

SCALE

2:1

WEIGHT 1,3g

SHEET

1/1

D

A

1

1

Luminaire: Ledil Oy CA12764&CA12838_FLARE-MINI-A (Cree XP-E 76lm @ 250mA) Efficiency=94%
Lamps: 1 x Cree XP-E 76lm @ 250mA

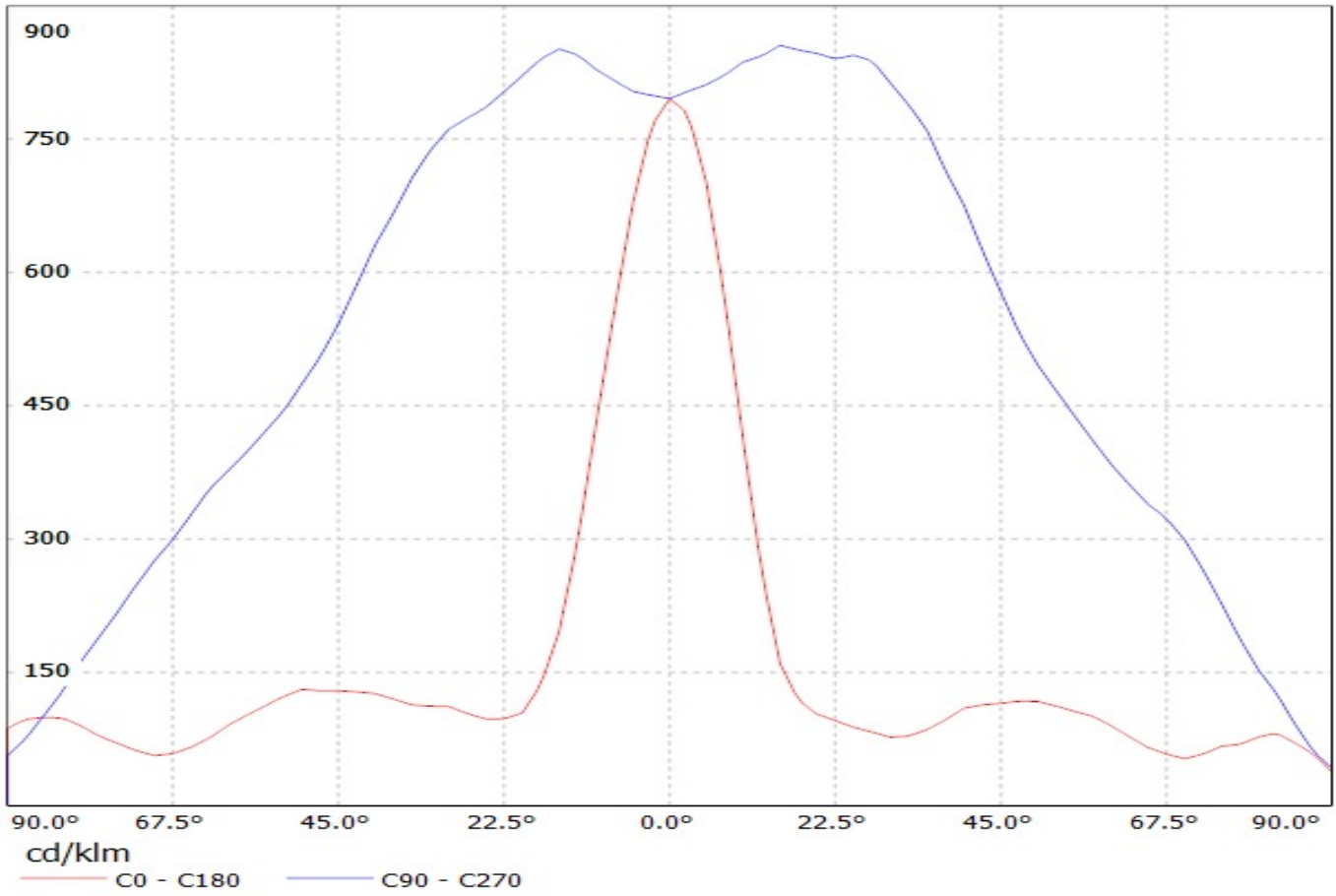

Luminaire: Ledil Oy CA12764&CA12838_FLARE-MINI-A (Cree XB-D 94lm @ 250mA) Efficiency=94%
Lamps: 1 x Cree XB-D 94lm @ 250mA

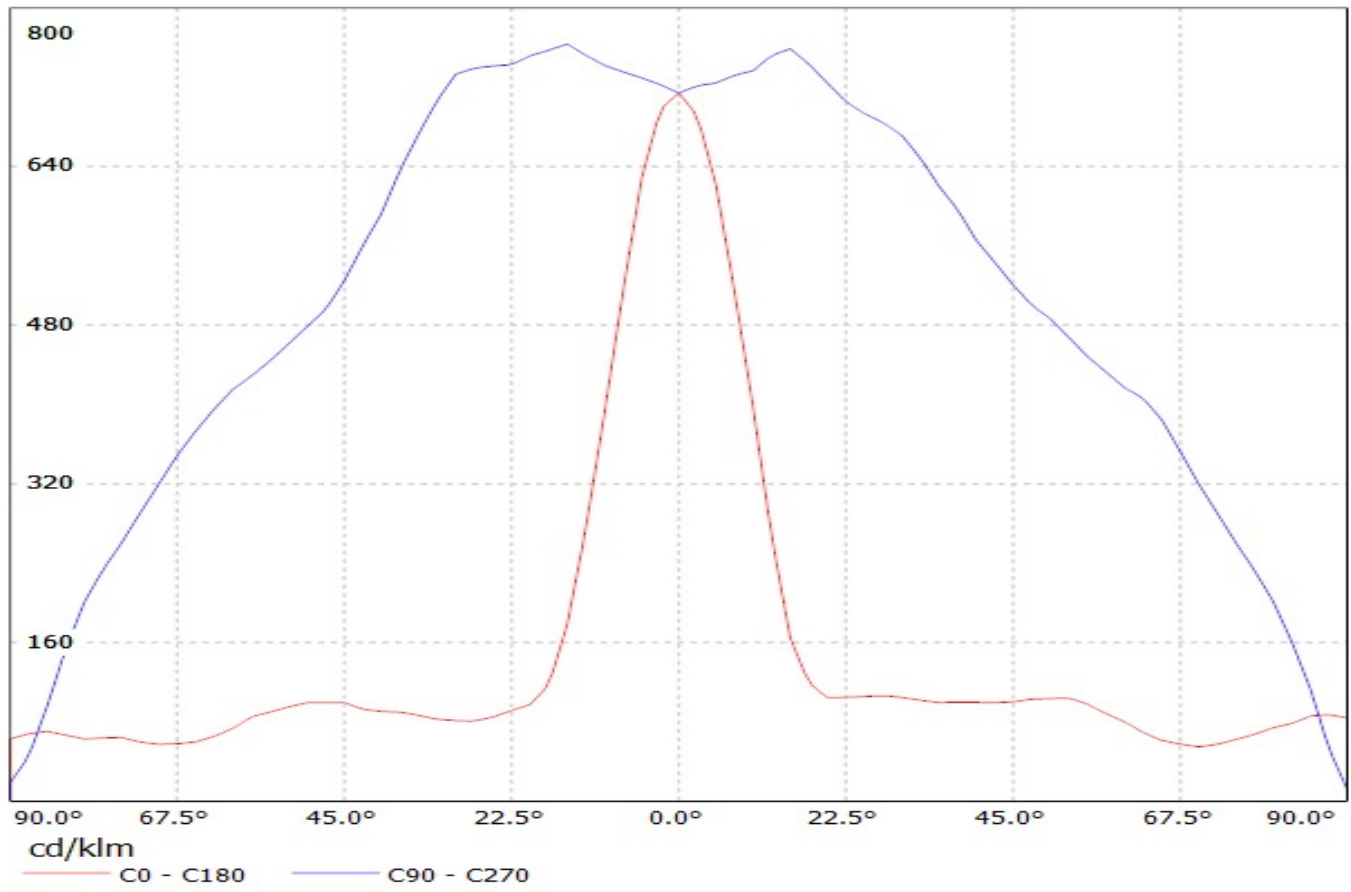

Luminaire: Ledil Oy CA12764/CA12838_FLARE-MINI-A (Cree XT-E 86lm @ 250mA) Efficiency=94%
Lamps: 1 x Cree XT-E 86lm @ 250mA

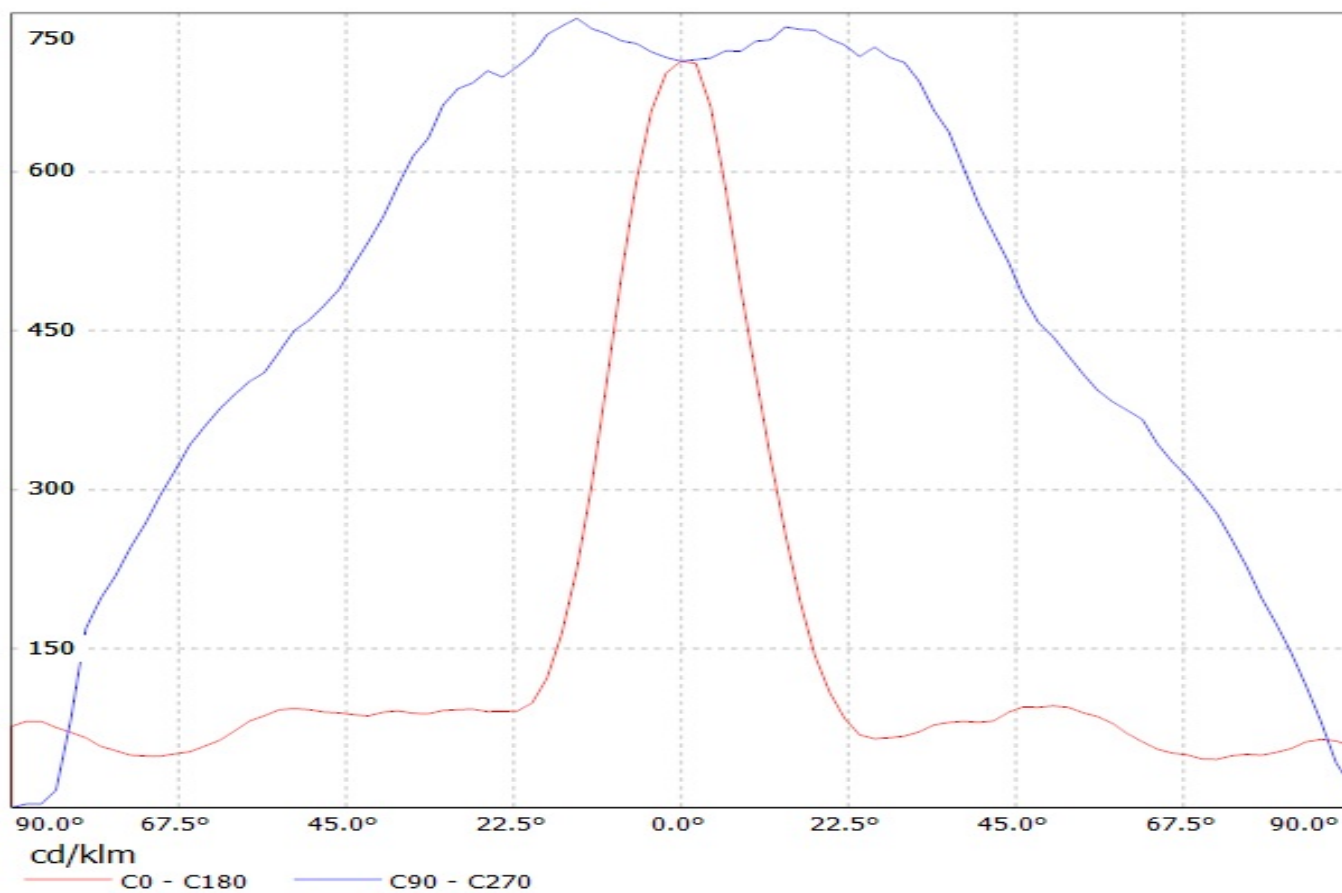

Luminaire: Ledil Oy CA12764&CA12838_FLARE-MINI-A (Cree XP-G 87lm @ 250mA) Efficiency=94%
Lamps: 1 x Cree XP-G 87lm @ 250mA

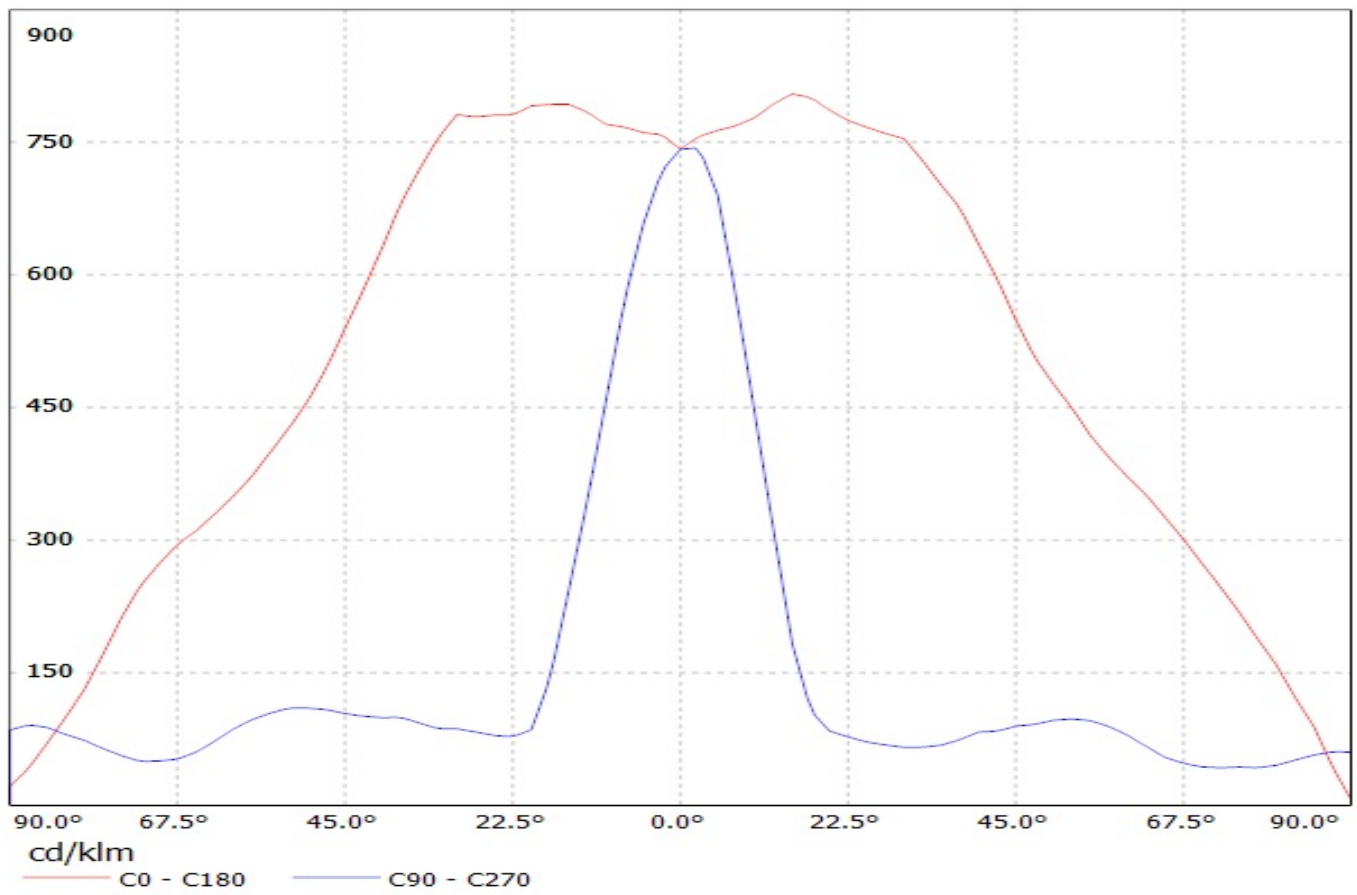

Luminaire: Ledil Oy CA12838_FLARE-MINI-A-PIN (CREE XP-E2 (92 lm @ 250 mA)) Efficiency=94%
Lamps: 1 x CREE XP-E2 (92 lm @ 250 mA)

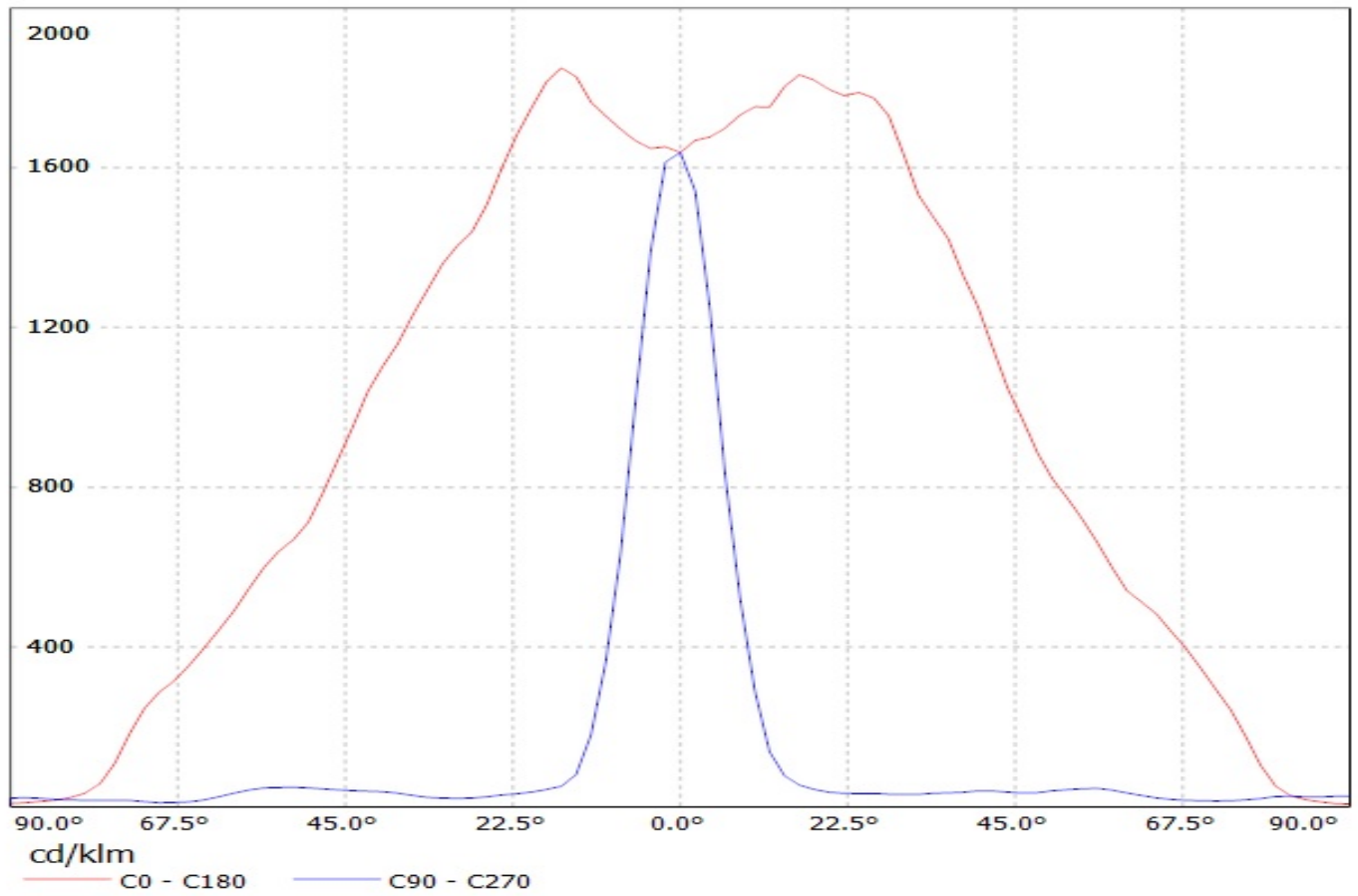

Luminaire: LEDiL Oy CA12838_FLARE-MINI-A-PIN_(XP-L) Eff.90.6%
Lamps: 1 x Cree_XP-L_127.813lm@250mA_P=0.73723W_I=249.9mA

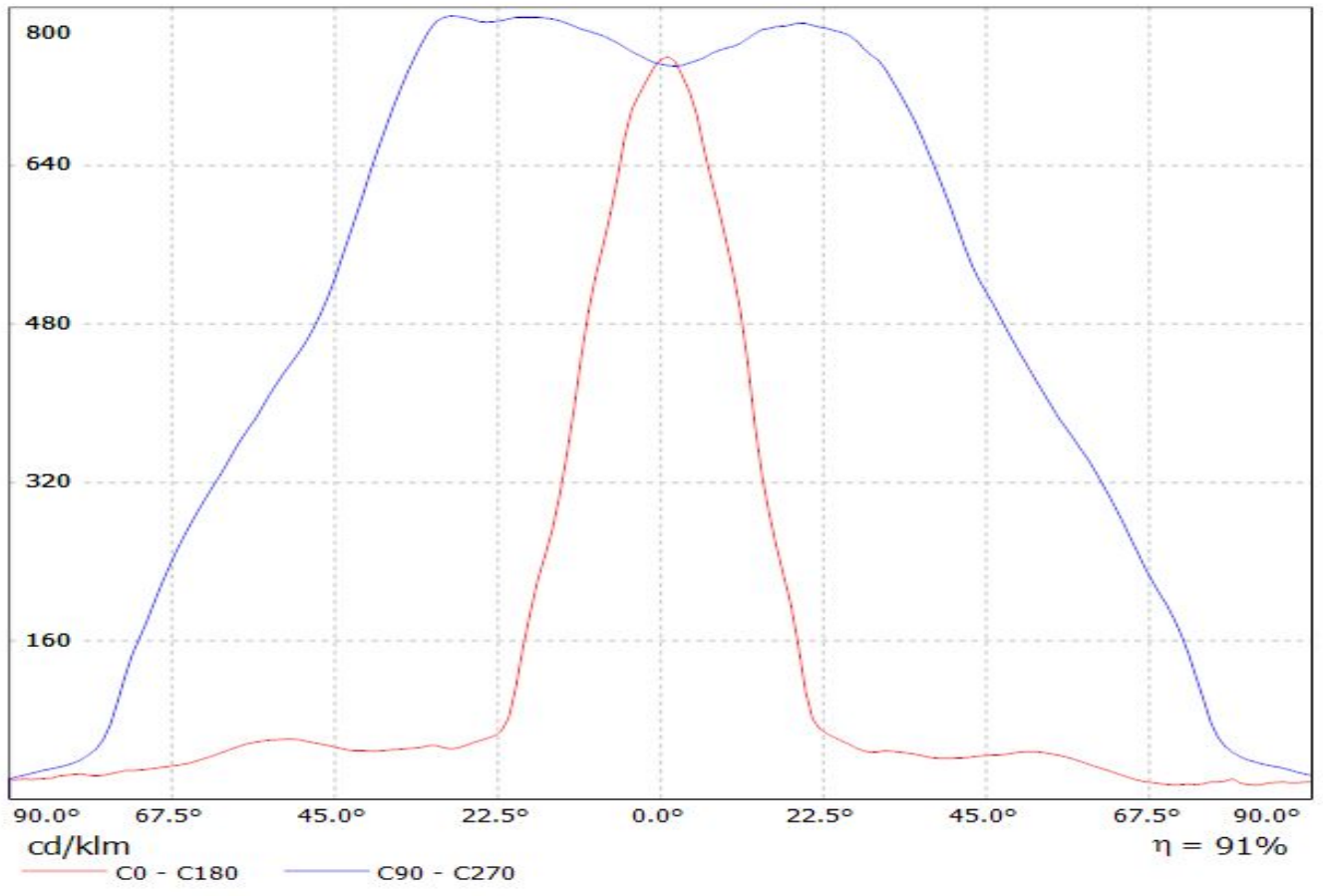

Luminaire: Ledil CA12838_FLARE-MINI-A-PIN_(XP-L2)

Lamps: 1 x Cree_XP-L2_(XPLWT-00-0000-000HU630G)_115.505lm@250mA_P=0.72165W_I=0.25A

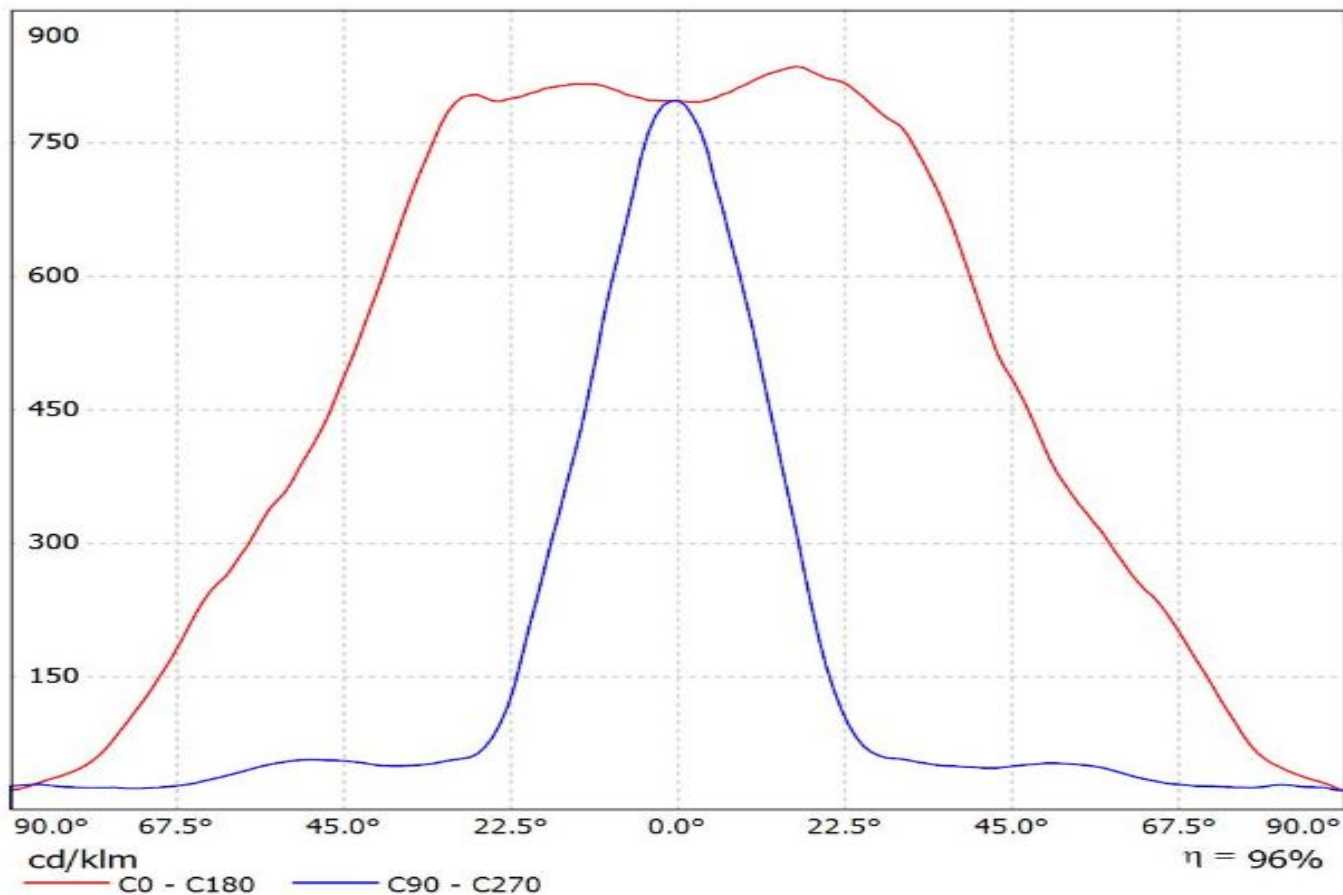

Luminaire: LEDiL Oy CA12838_FLARE-MINI-A-PIN_(LG-3535-CERAMIC-GEN2) Eff.94%
Lamps: 1 x LG-3535-CERAMIC-GEN2_116.256lm@250mA_P=0.754973W_CCT=6235K_I=249.9mA

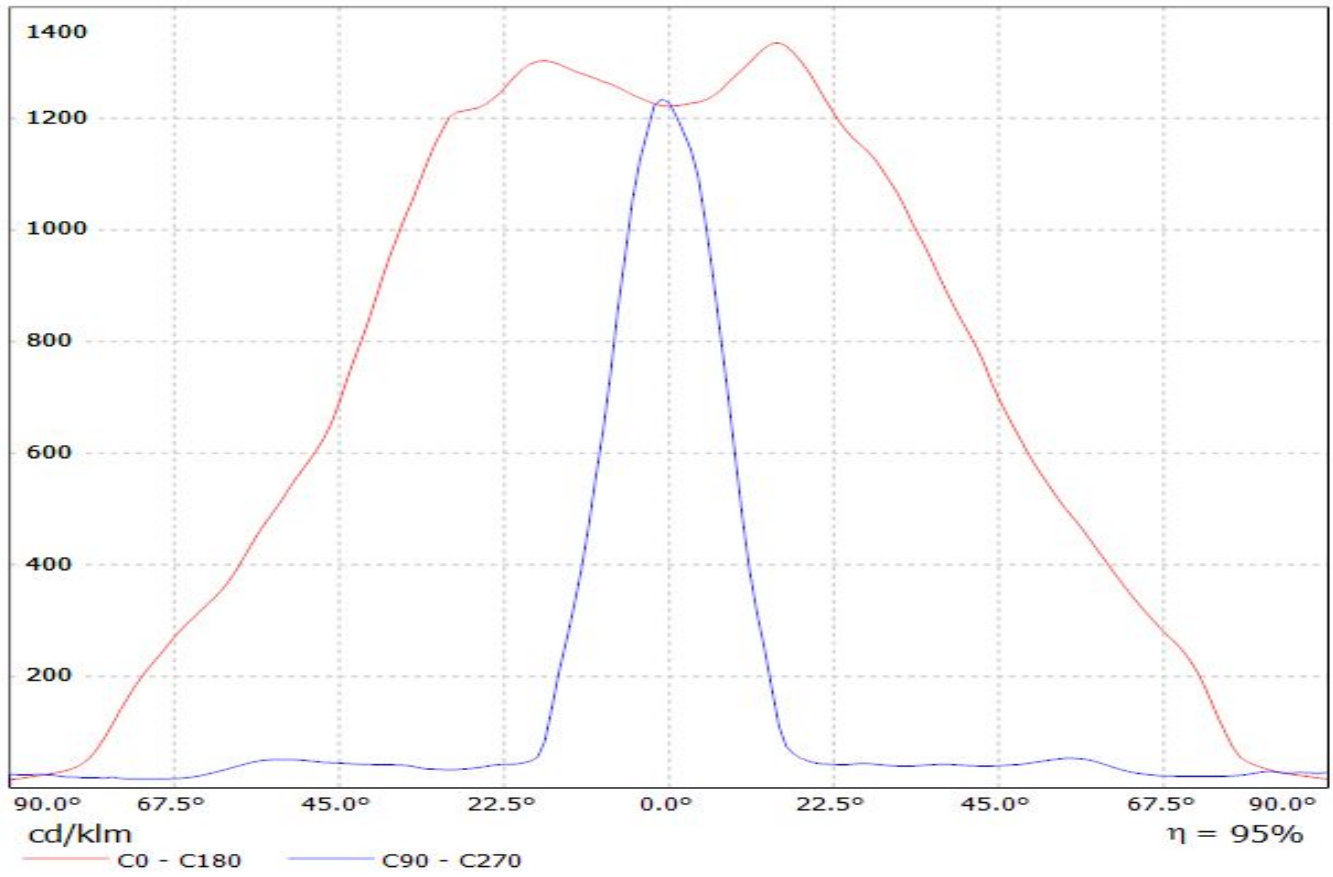

Luminaire: Ledil Oy CA12764/CA12838_FLARE-MINI-A (Luxeon Rebel ES 92lm @ 250mA) Efficiency=94%
Lamps: 1 x Luxeon Rebel ES 92lm @ 250mA

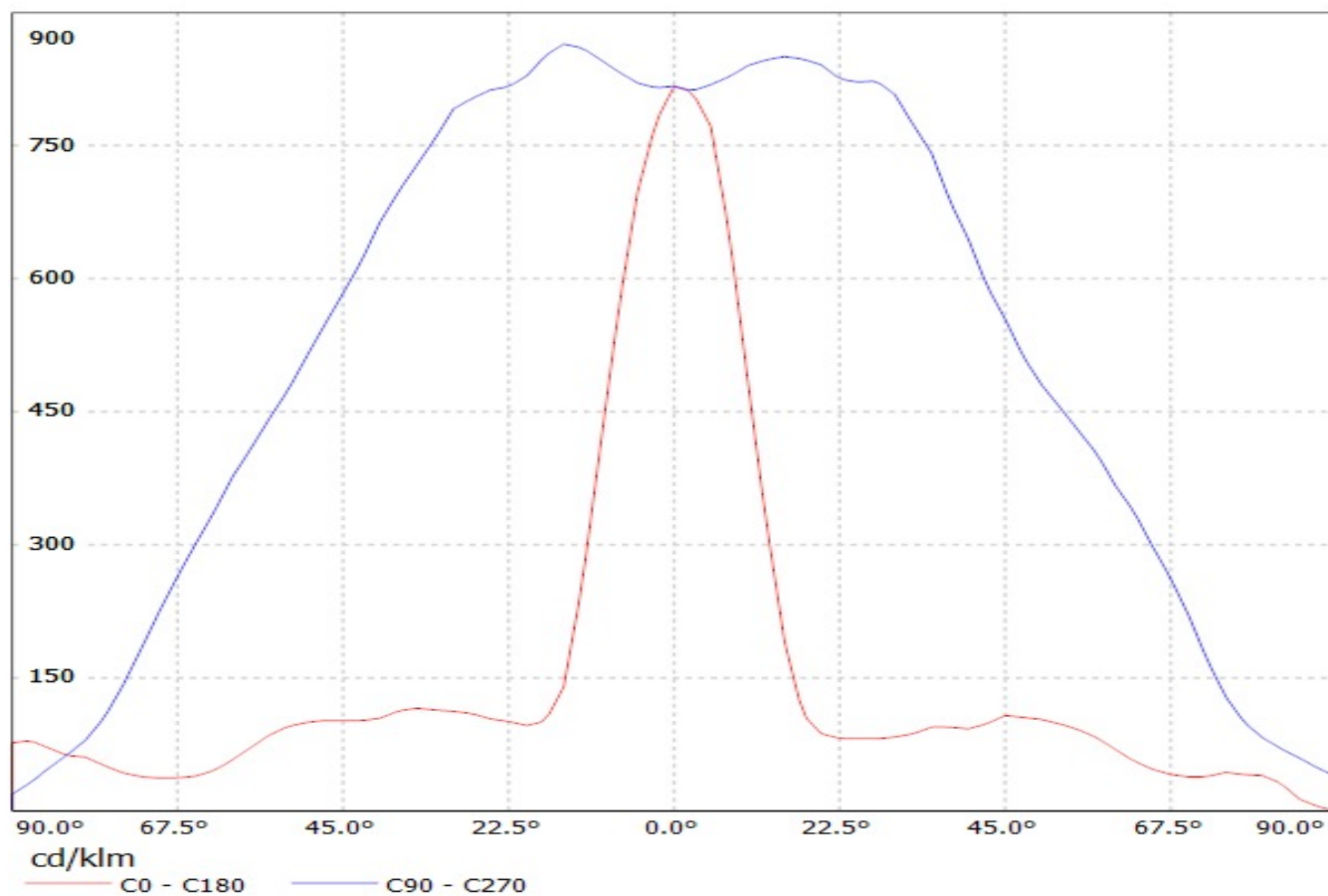

Luminaire: LEDiL Oy CA12838_FLARE-MINI-A-PIN_(LUXEON_T)_1 Eff.92.5%
Lamps: 1 x LUXEON T (74lm@250mA)

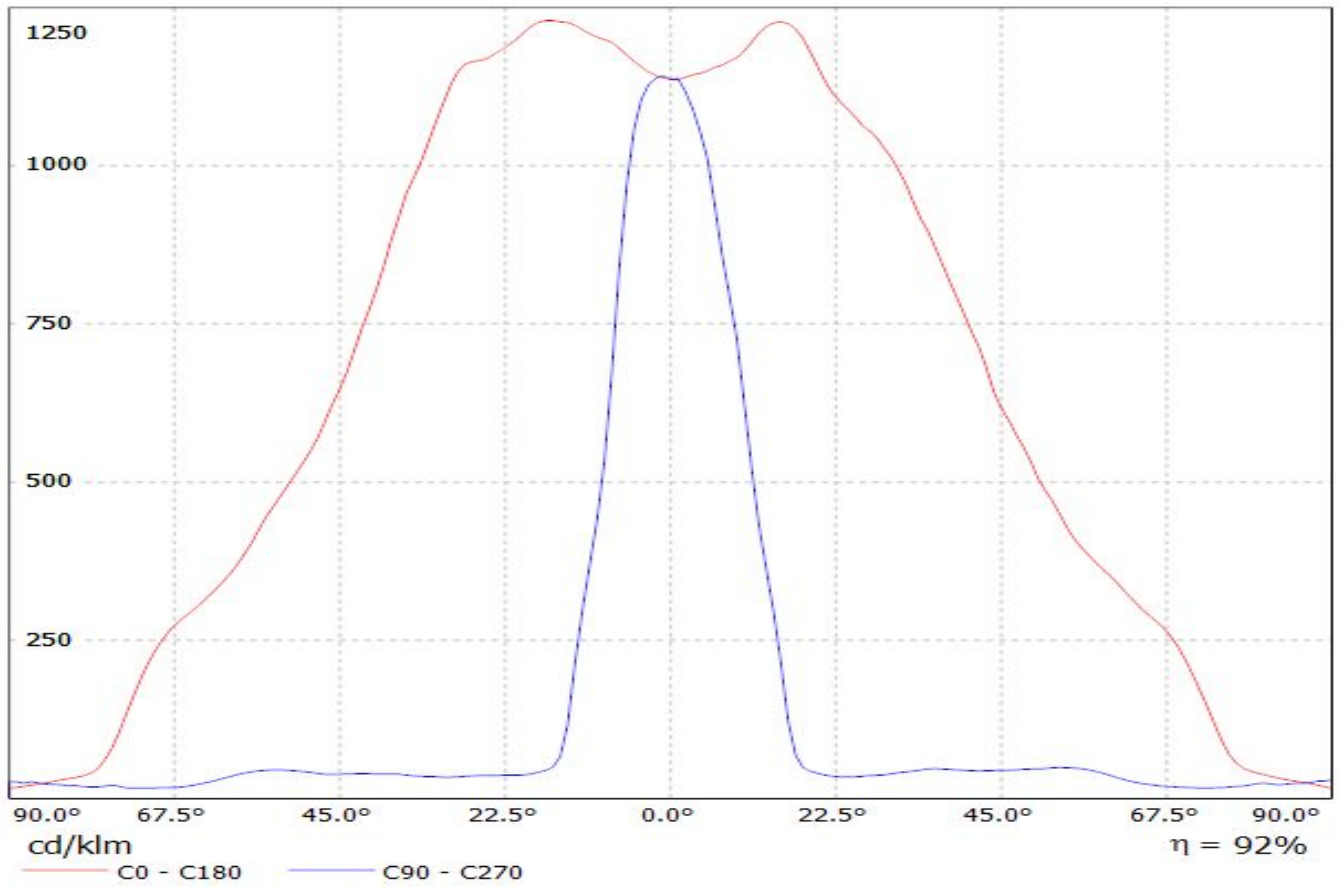

Luminaire: Ledil Oy CA12838_FLARE-MINI-A-PIN_(Luxeon_TX)
Lamps: 1 x Luxeon TX (77.6lm @ 250mA) P=0.7W I=250mA

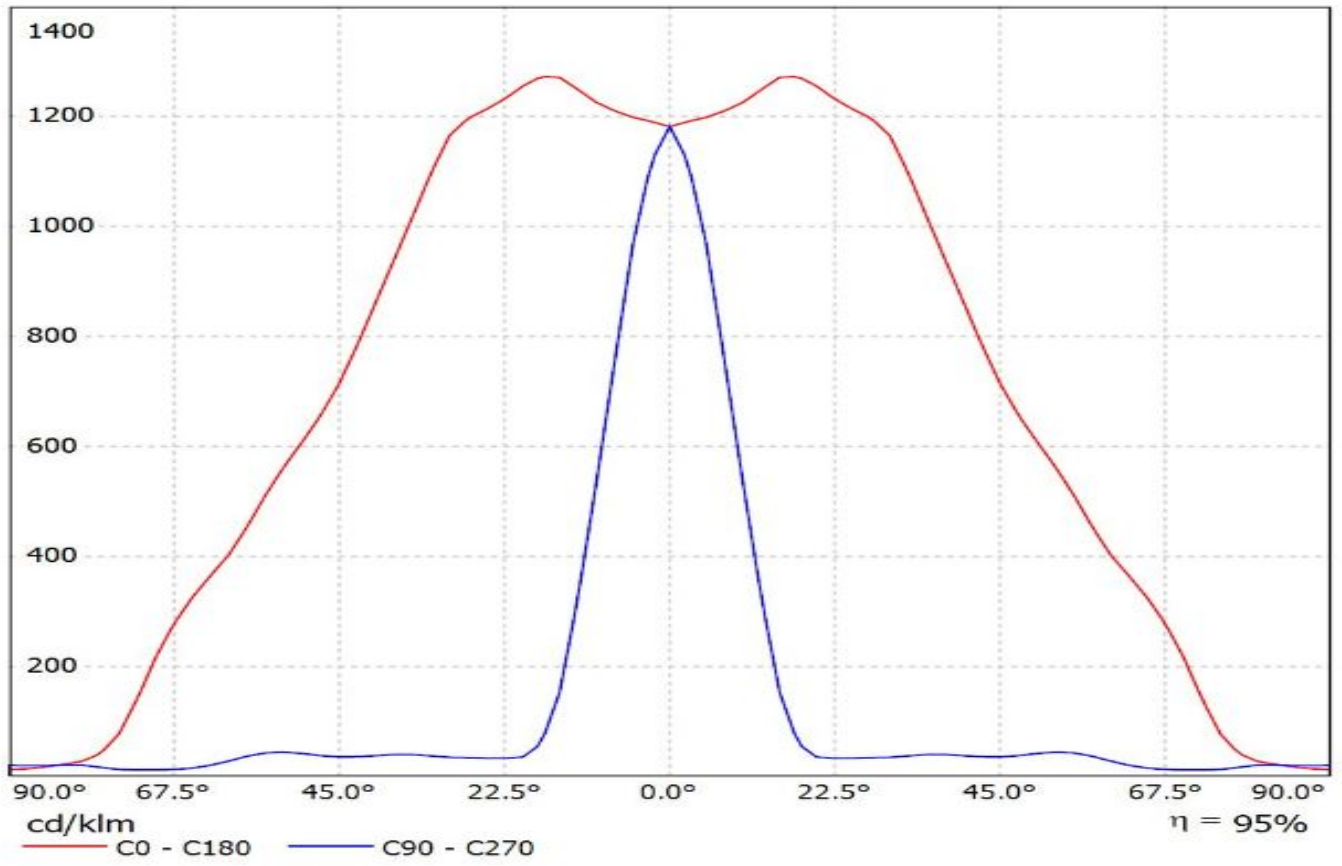

Luminaire: Ledil Oy CA12764&CA12838_FLARE-MINI-A (Nichia NCS19 95lm @ 250mA) Efficiency=94%
Lamps: 1 x Nichia NCS19 95lm @ 250mA

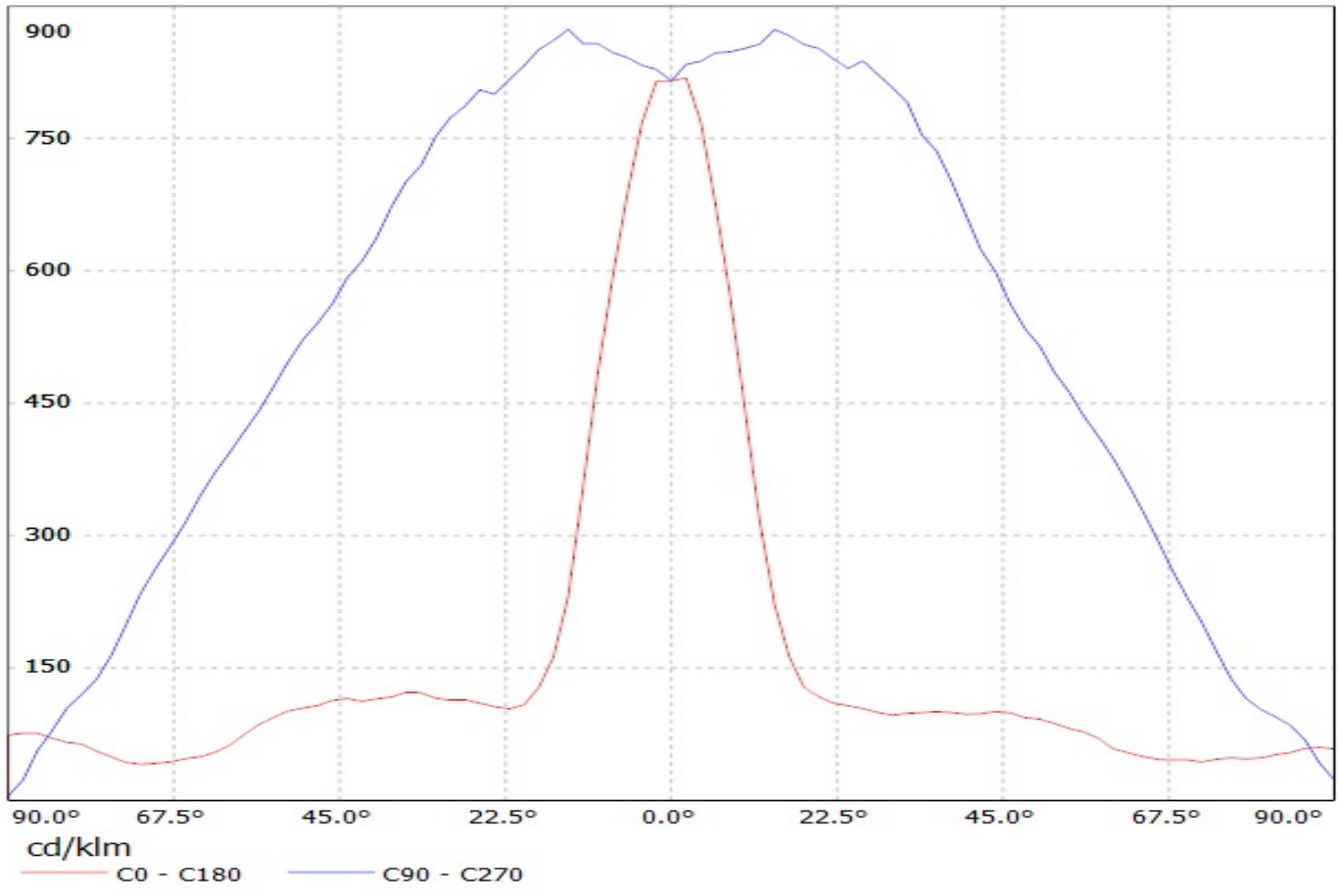

Luminaire: Ledil Oy CA12838_Flare_Mini-A-Pin_(NCSxx19B) Efficiency=94%
Lamps: 1 x Nichia NCSxx19B (NCSL119BE) 88.1lm @ 250mA CCT=3000K P=0.8W I=250mA

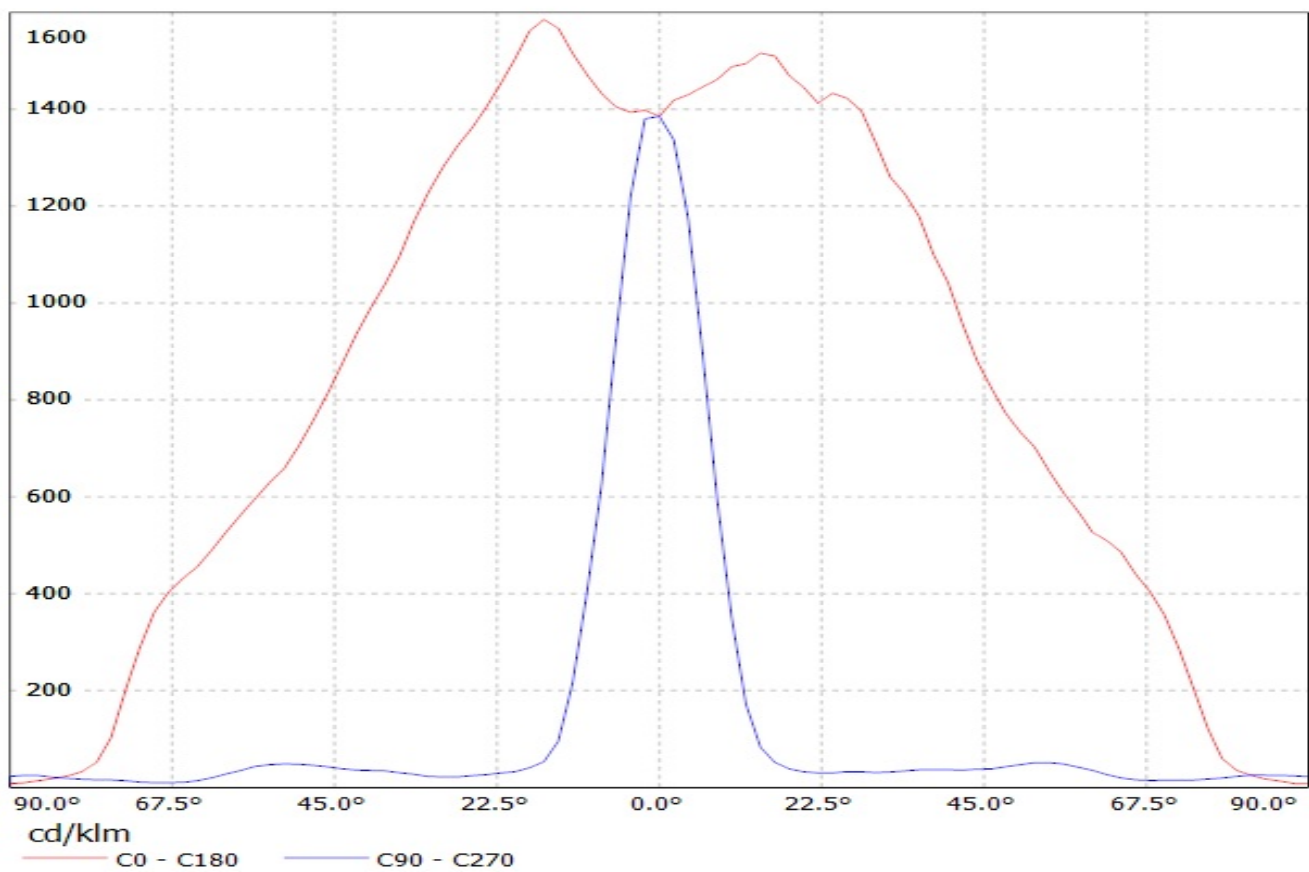

Luminaire: LEDiL Oy CA12838_FLARE-MINI-A-PIN_(NVSL219CE)
Lamps: 1 x Nichia_NVSL219CE_101.227lm@250mA_P=0.713404W_I=0.25A

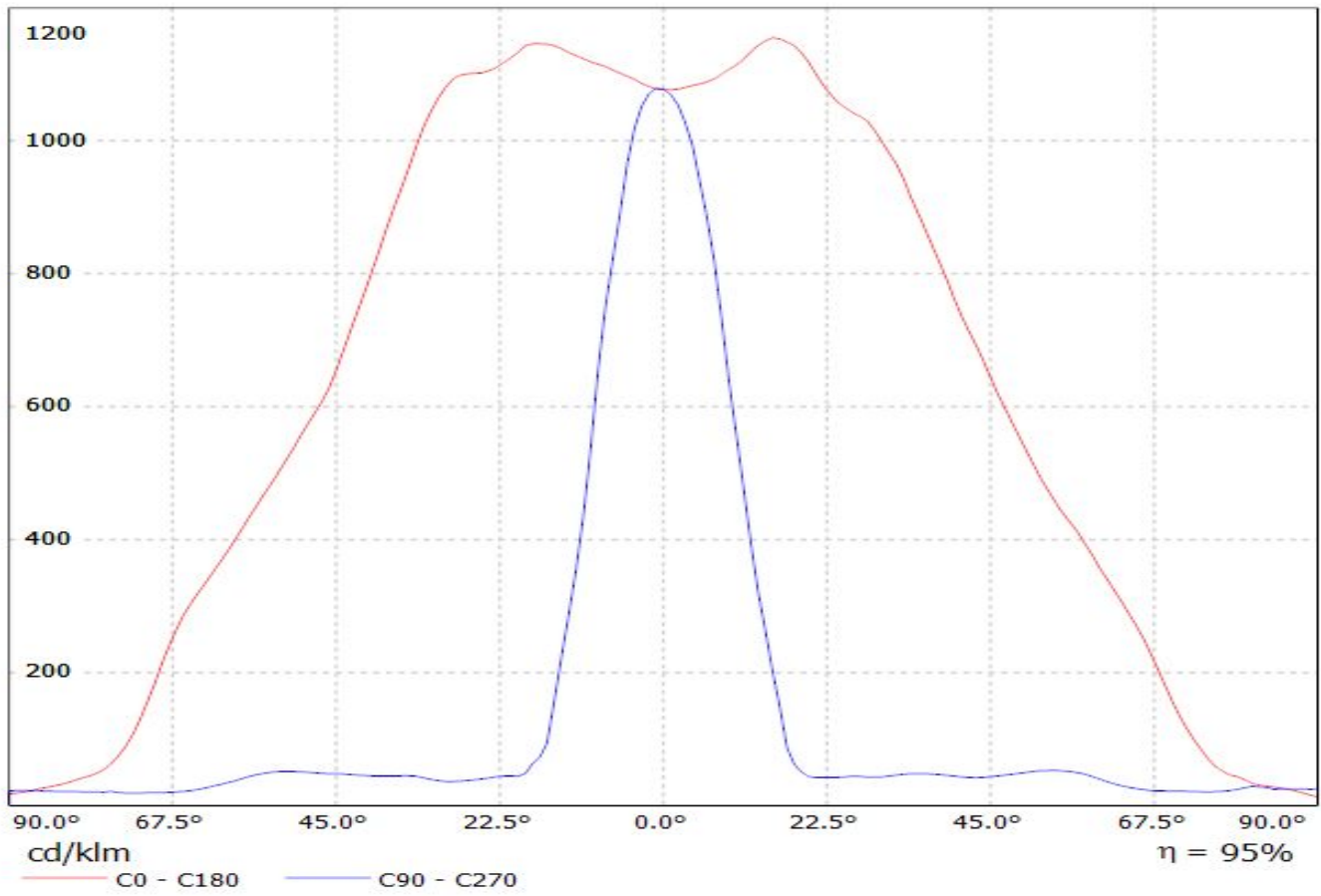

Luminaire: Ledil Oy CA12764&CA12838_FLARE-MINI-A (Osram Square PC 88lm @ 250mA) Efficiency=94%
Lamps: 1 x Osram Square PC 88lm @ 250mA

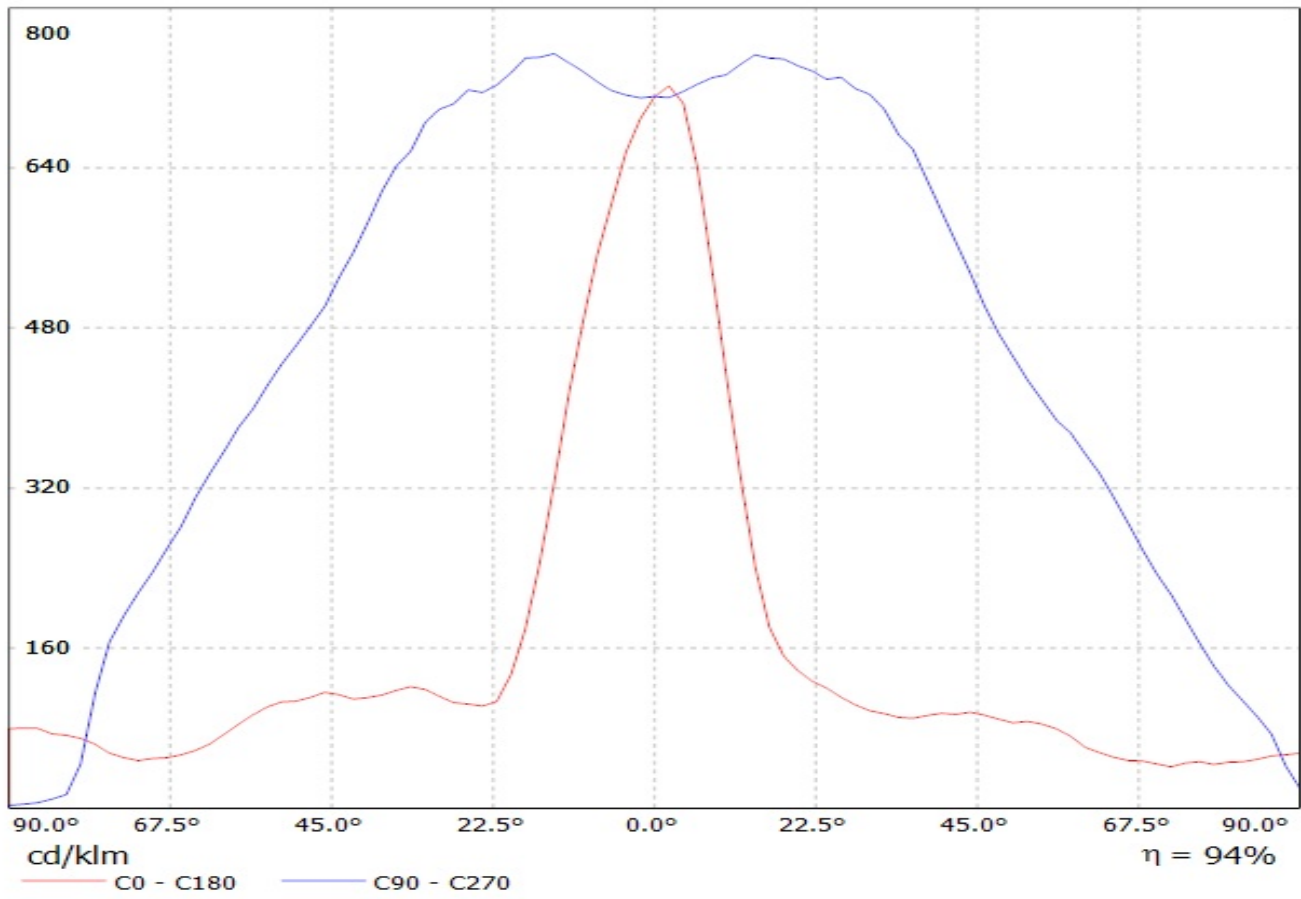

Luminaire: Ledil Oy CA12764/CA12838_FLARE-MINI-A (Osram OSL80 84lm @ 250mA) Efficiency=93%
Lamps: 1 x Osram OSL80 84lm @ 250mA

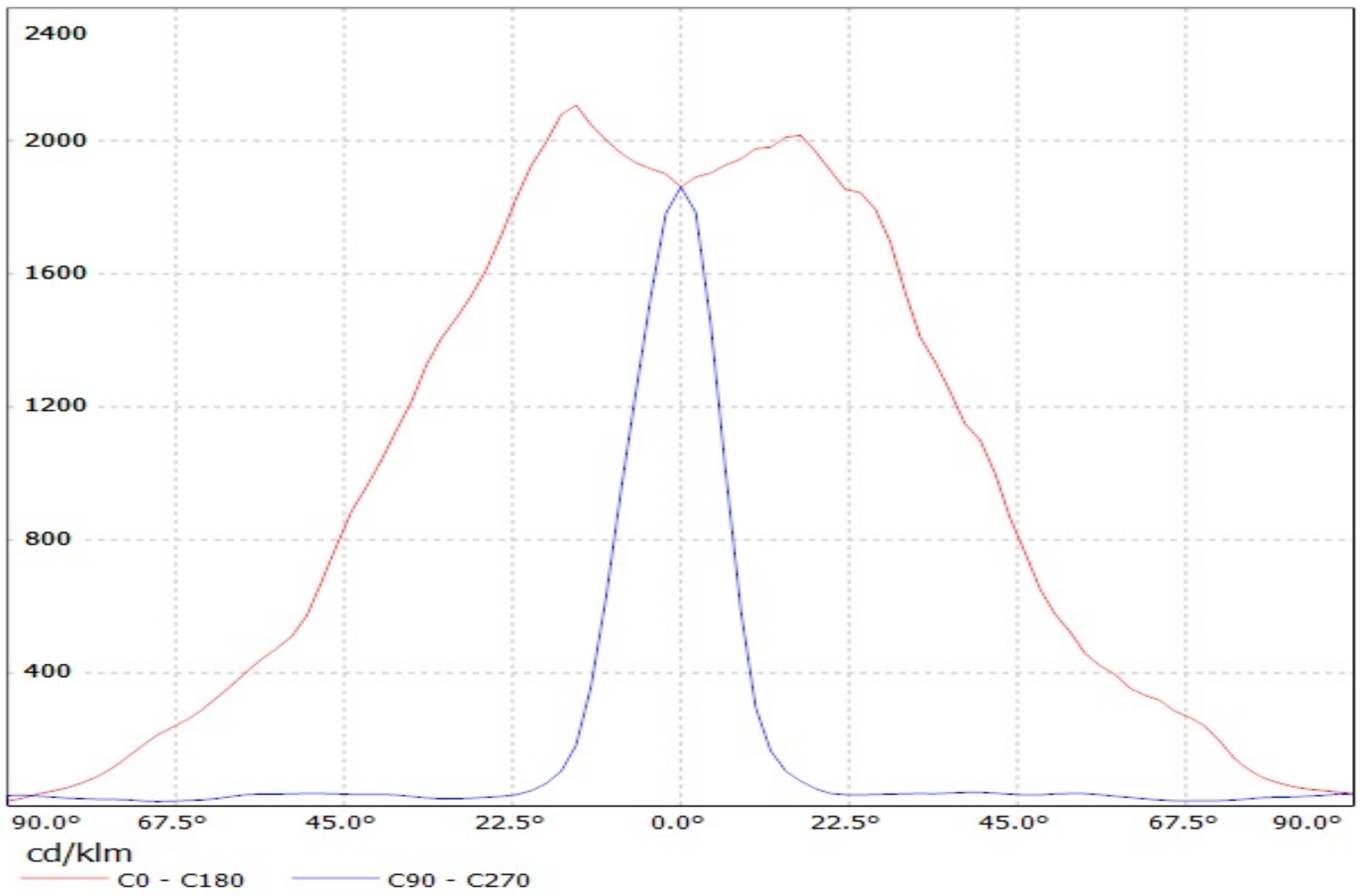

Luminaire: Ledil Oy C12763/C12837_FLARE-MINI-A (Osram OSL150 95lm @ 250mA) Efficiency=93%
Lamps: 1 x Osram OSL150 95lm @ 250mA

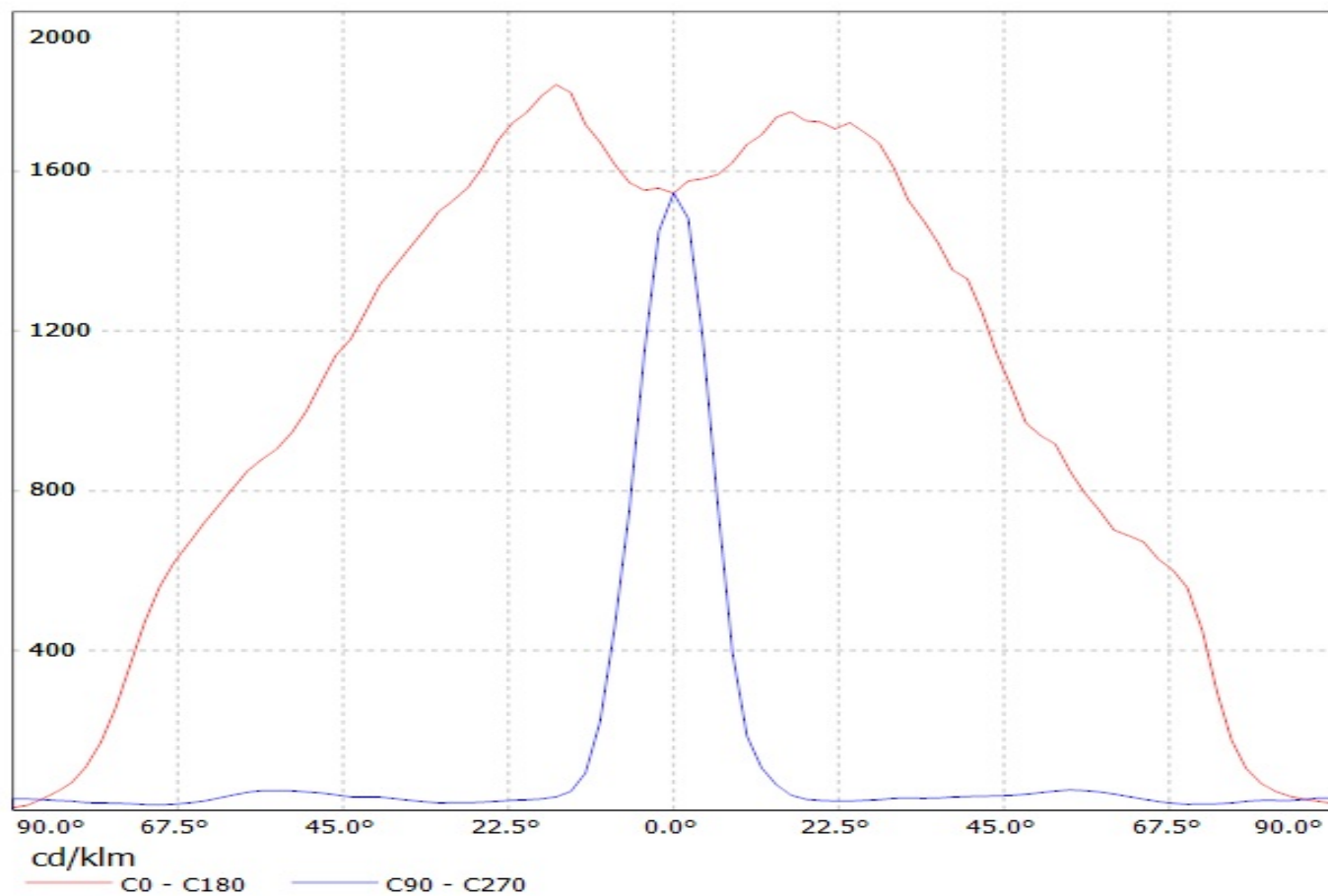

Luminaire: LEDil Oy CA12838_FLARE-MINI-A-PIN_(LH351Z)
Lamps: 1 x Samsung LH351Z (90.14lm @ 250mA) CCT=6500K P=0.7W I=250mA

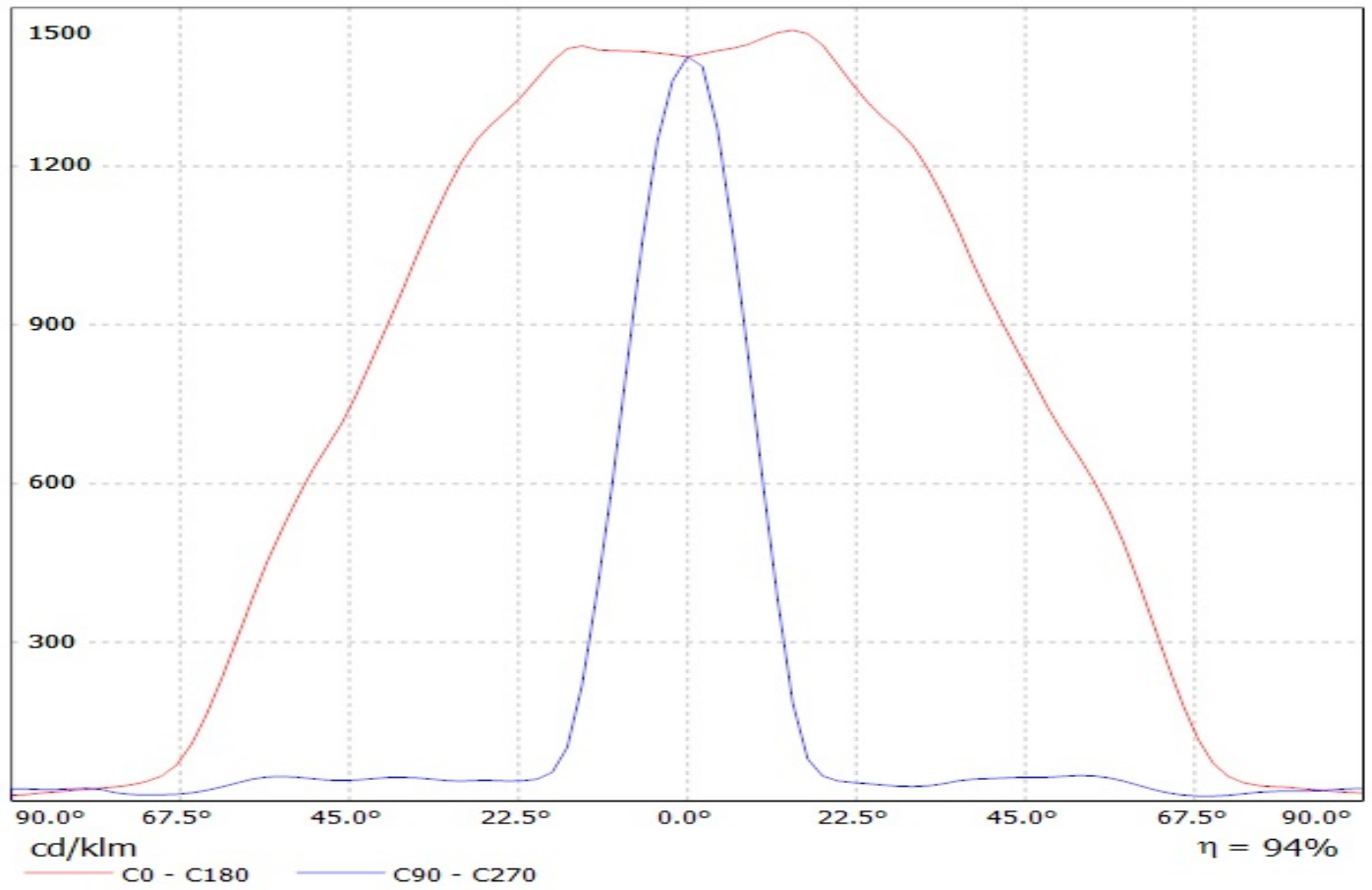

Luminaire: Ledil Oy CA12764&CA12838_FLARE-MINI-A (Cree XP-E 76lm @ 250mA) Efficiency=94%
Lamps: 1 x Cree XP-E 76lm @ 250mA

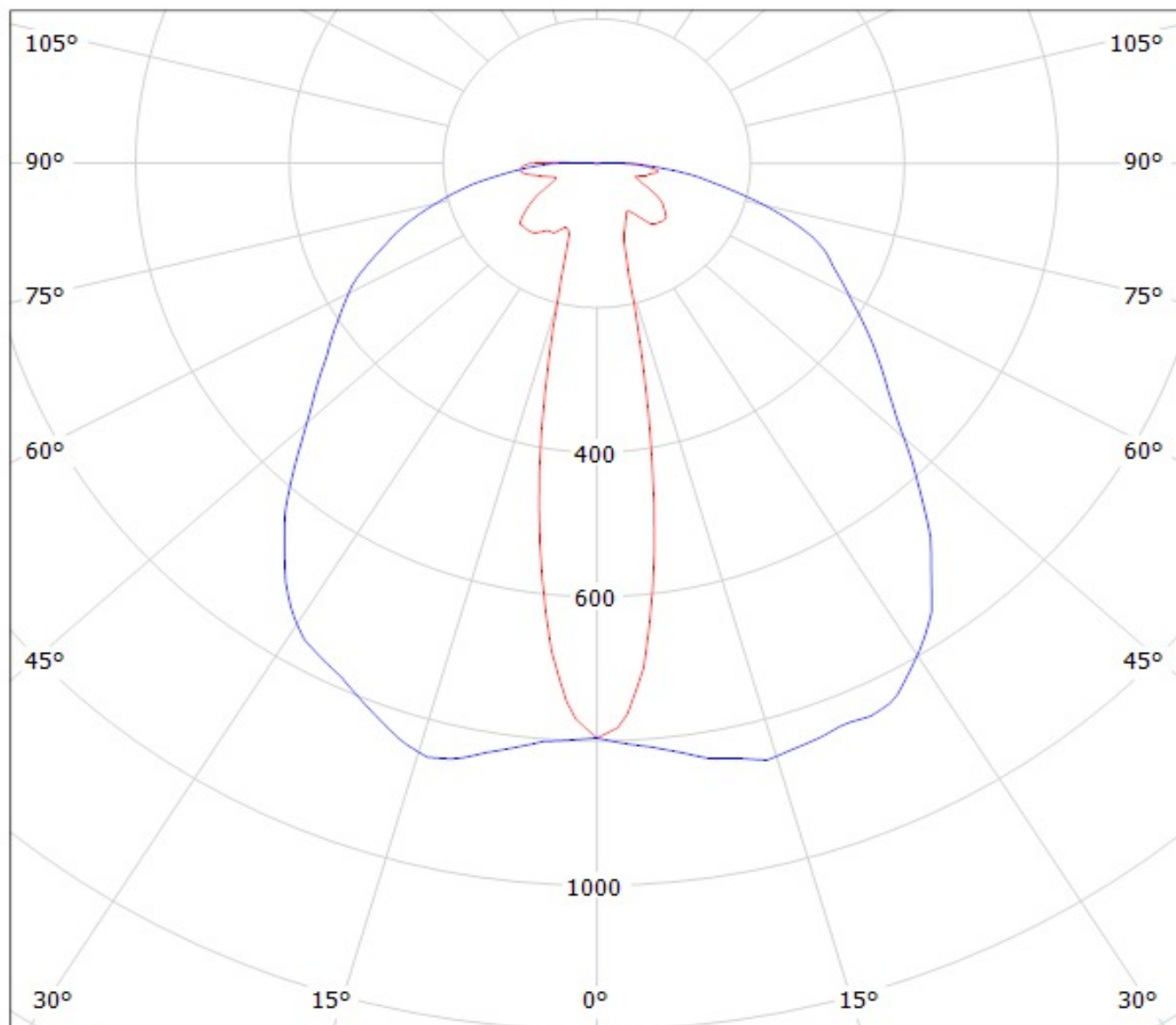

cd/klm

— C0 - C180

— C90 - C270

Luminaire: Ledil Oy CA12764&CA12838_FLARE-MINI-A (Cree XB-D 94lm @ 250mA) Efficiency=94%
Lamps: 1 x Cree XB-D 94lm @ 250mA

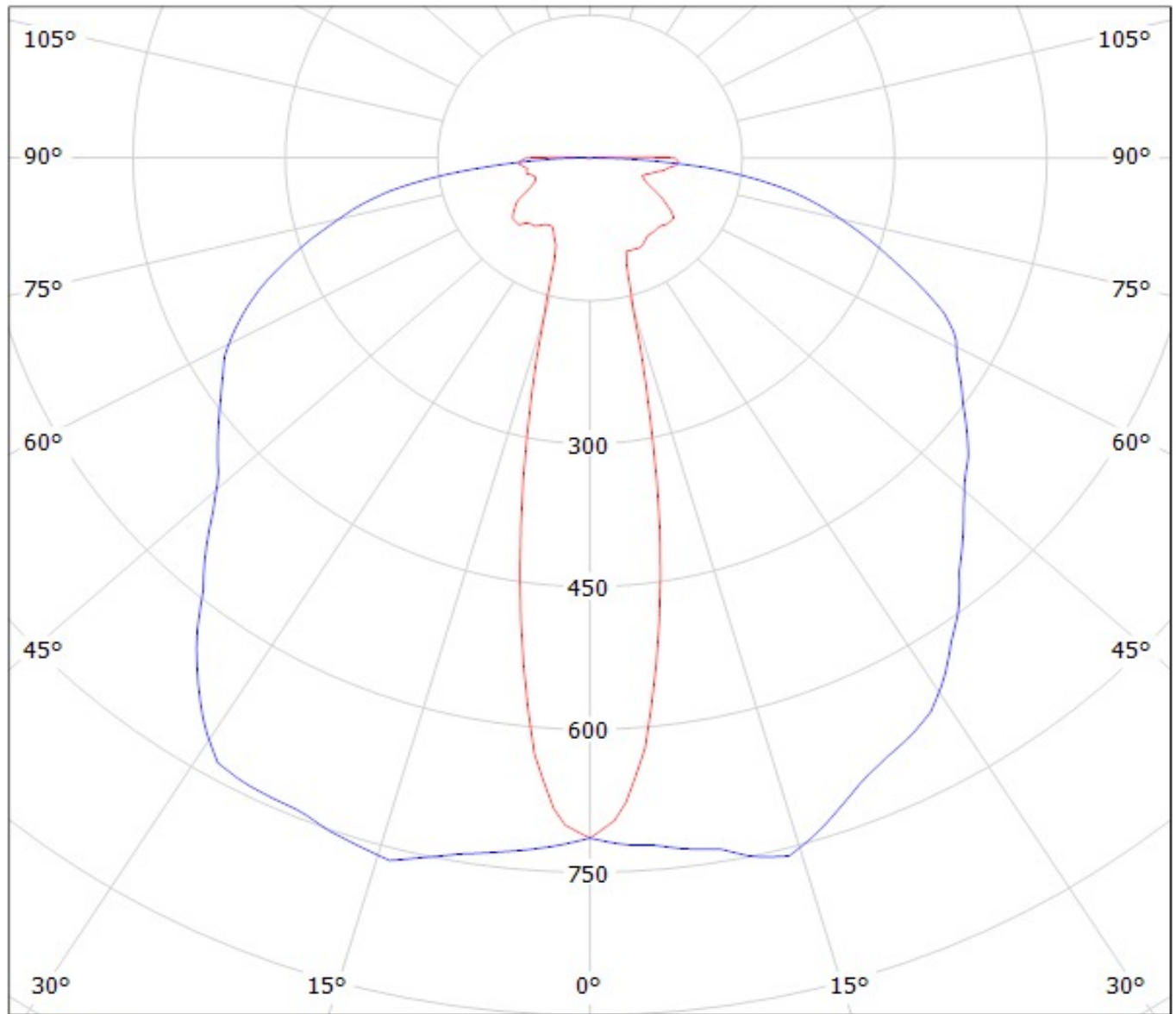

cd/klm

— C0 - C180 — C90 - C270

Luminaire: Ledil Oy CA12764/CA12838_FLARE-MINI-A (Cree XT-E 86lm @ 250mA) Efficiency=94%
Lamps: 1 x Cree XT-E 86lm @ 250mA

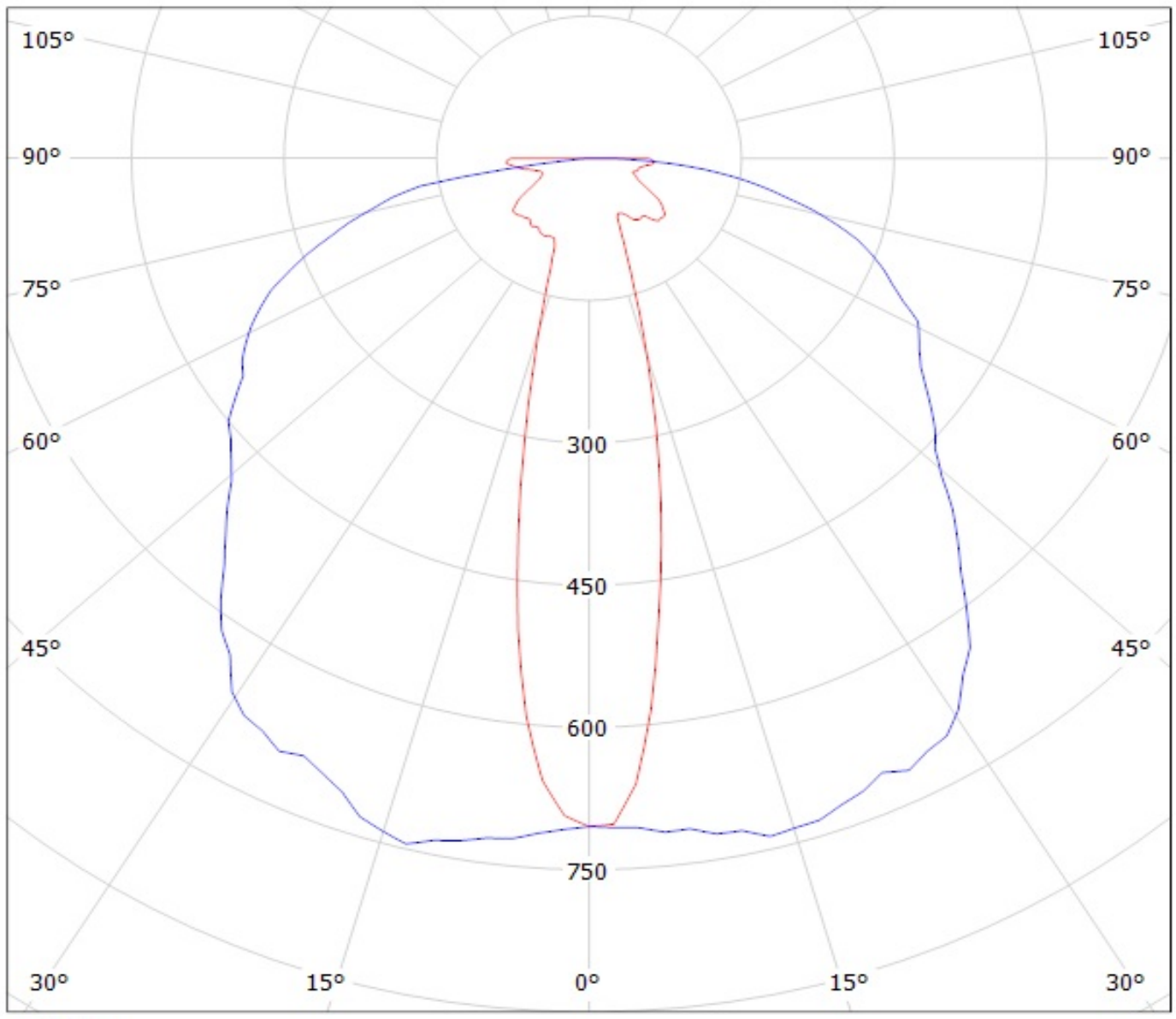

cd/klm
— C0 - C180 — C90 - C270

Luminaire: Ledil Oy CA12764&CA12838_FLARE-MINI-A (Cree XP-G 87lm @ 250mA) Efficiency=94%
Lamps: 1 x Cree XP-G 87lm @ 250mA

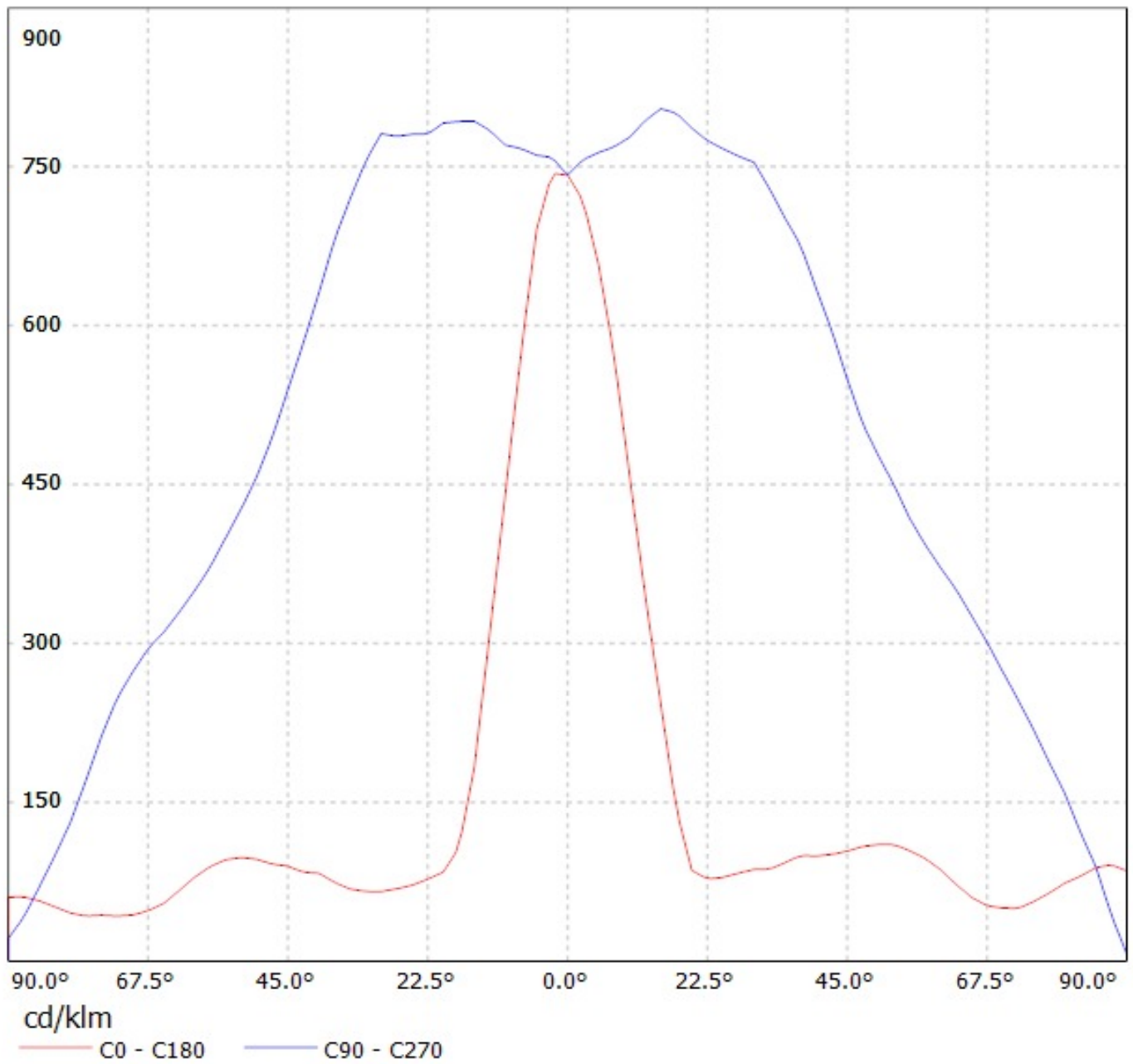

Luminaire: Ledil Oy CA12838_FLARE-MINI-A-PIN (CREE XP-G2 (99 lm @ 250 mA)) Efficiency=94%
Lamps: 1 x CREE XP-G2 (99 lm @ 250 mA)

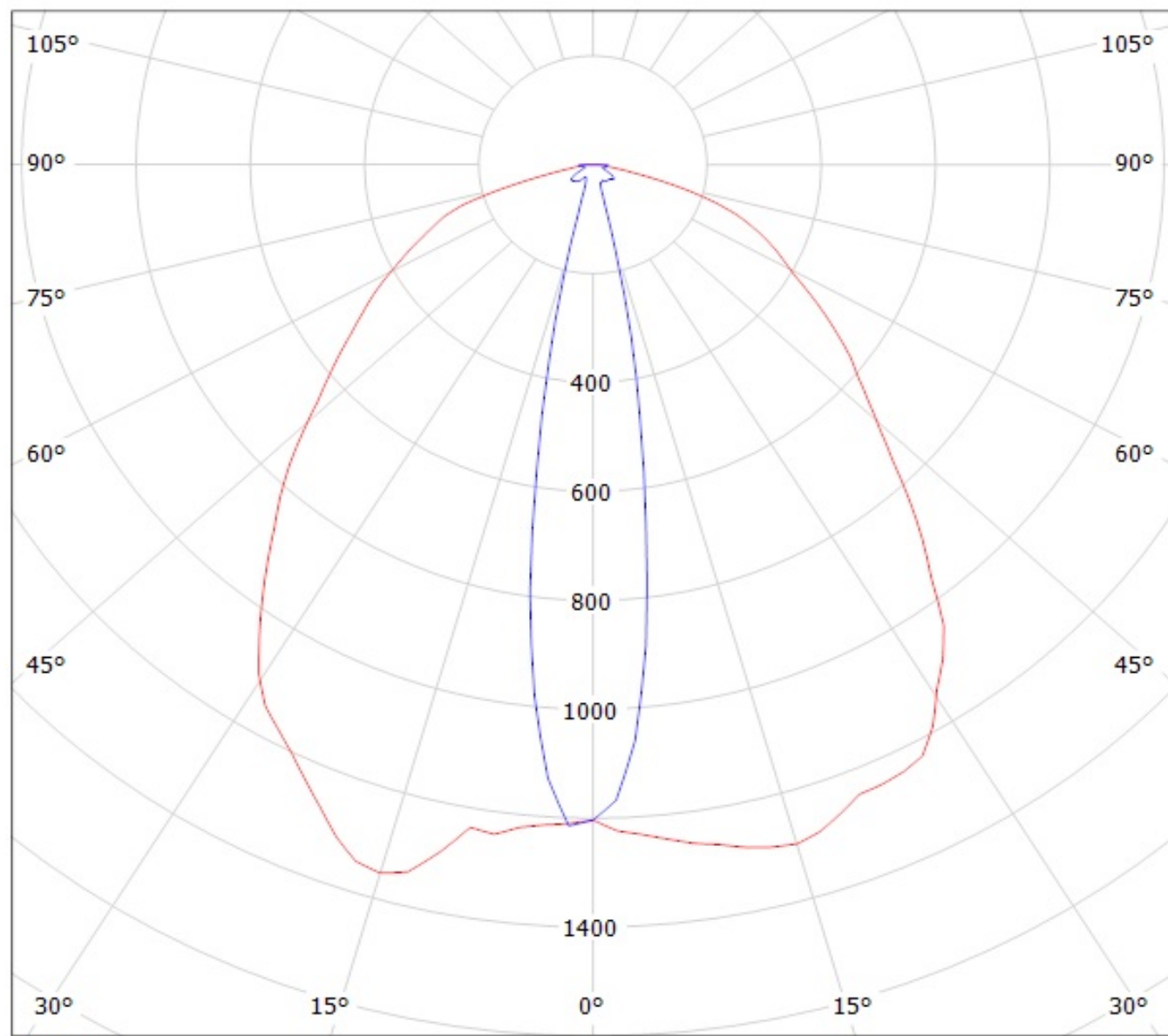

cd/klm

— C0 - C180

— C90 - C270

Luminaire: Ledil Oy CA12838_FLARE-MINI-A-PIN (CREE XP-E2 (92 lm @ 250 mA)) Efficiency=94%
Lamps: 1 x CREE XP-E2 (92 lm @ 250 mA)

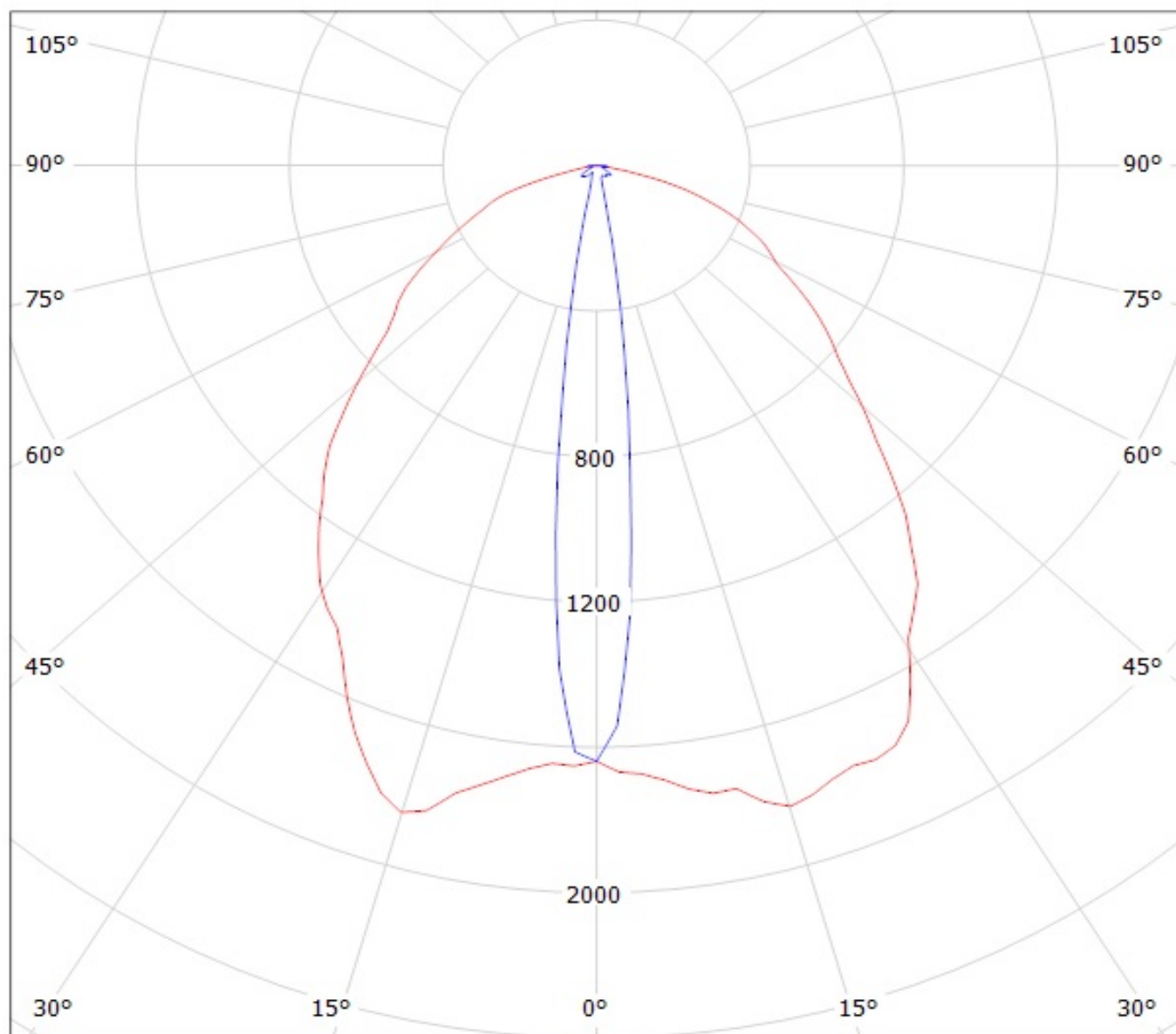

cd/klm

— C0 - C180

— C90 - C270

Luminaire: LEDiL Oy CA12838_FLARE-MINI-A-PIN_(XP-L) Eff.90.6%
Lamps: 1 x Cree_XP-L_127.813lm@250mA_P=0.73723W_I=249.9mA

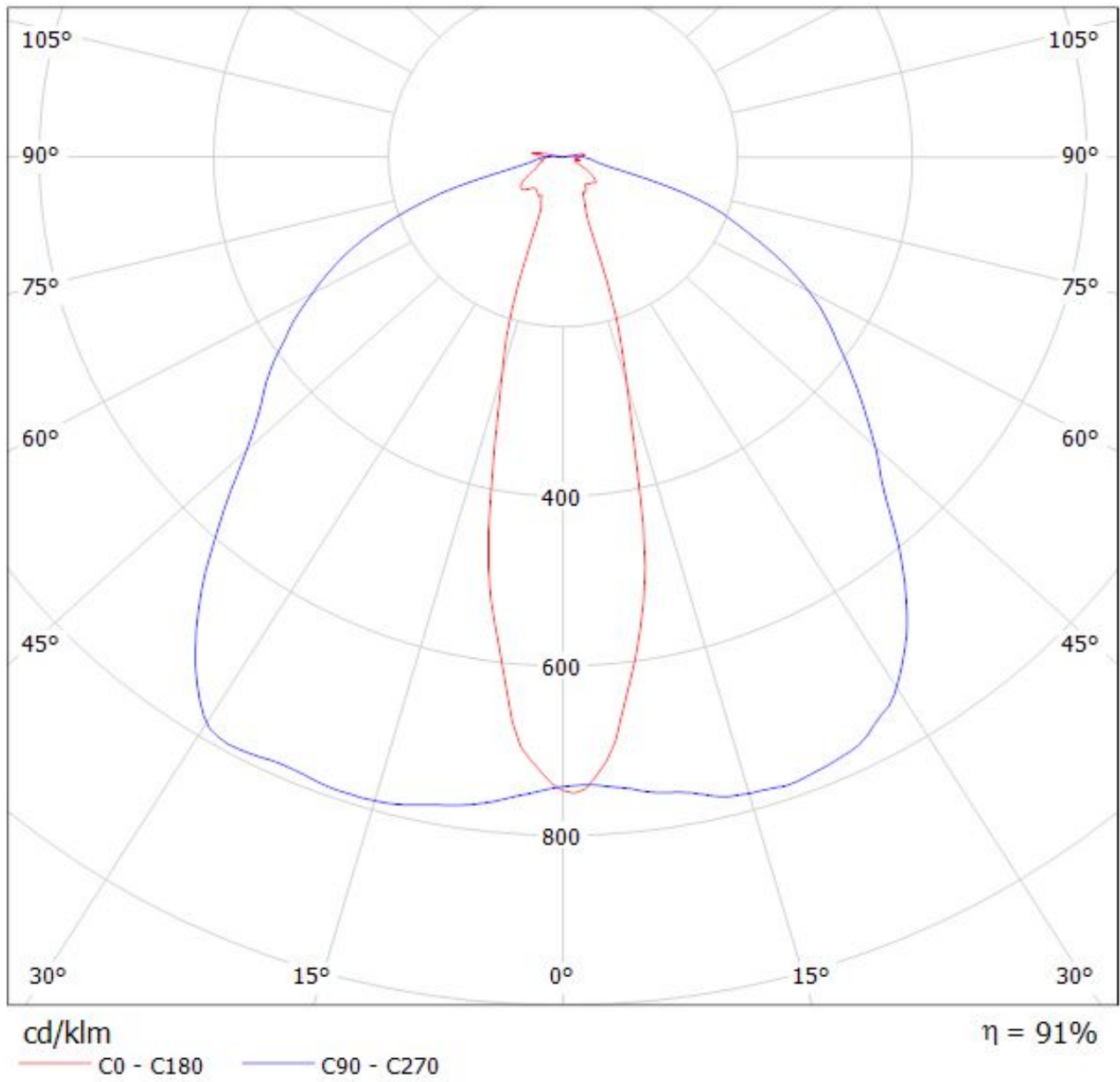

Luminaire: Ledil CA12838_FLARE-MINI-A-PIN_(XP-L2)

Lamps: 1 x Cree_XP-L2_(XPLWT-00-0000-000HU630G)_115.505lm@250mA_P=0.72165W_I=0.25A

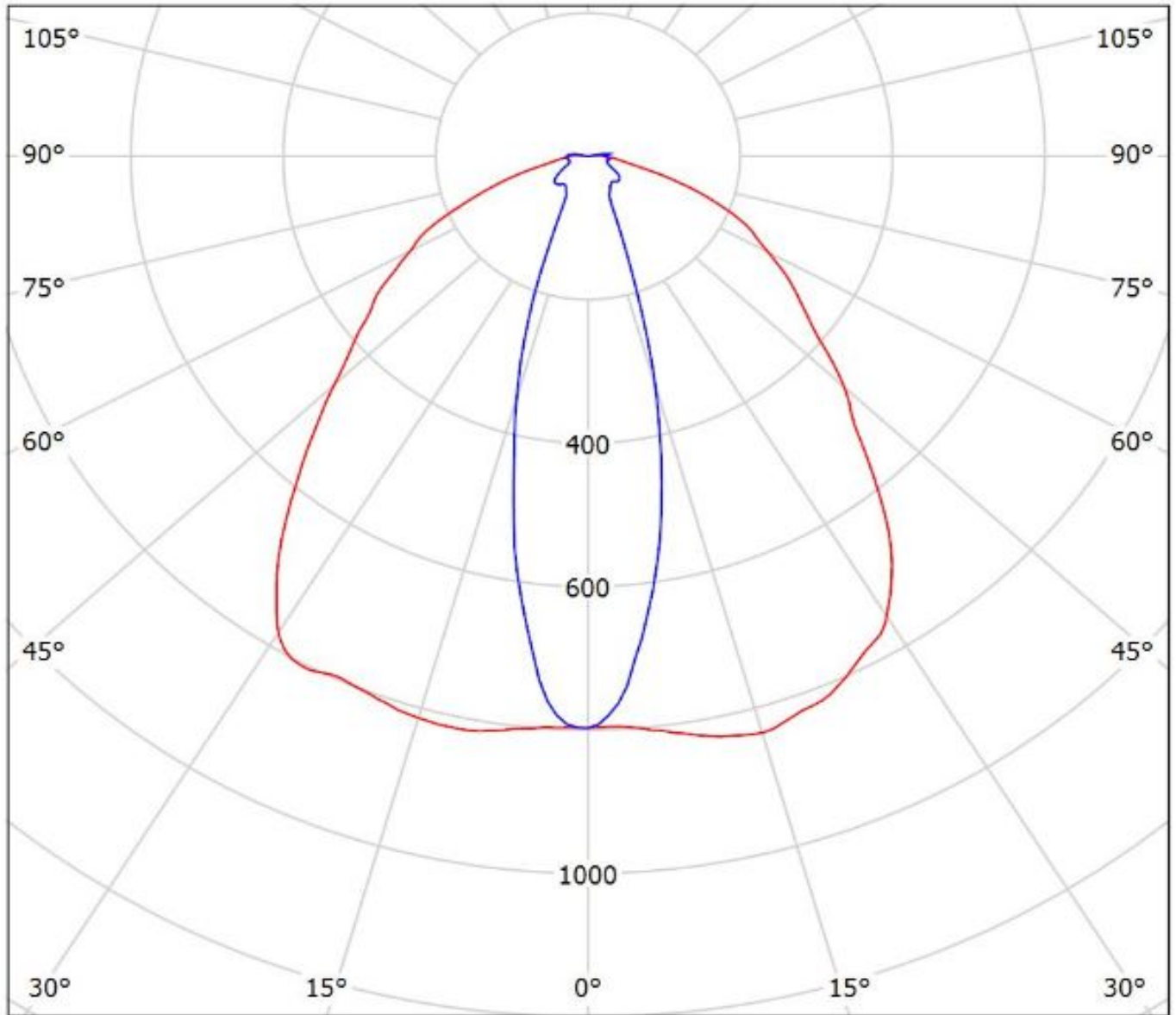

cd/klm
— C0 - C180 — C90 - C270

$\eta = 96\%$

Luminaire: LEDiL Oy CA12838_FLARE-MINI-A-PIN_(LG-3535-CERAMIC-GEN2) Eff.94%
Lamps: 1 x LG-3535-CERAMIC-GEN2_116.256lm@250mA_P=0.754973W_CCT=6235K_I=249.9mA

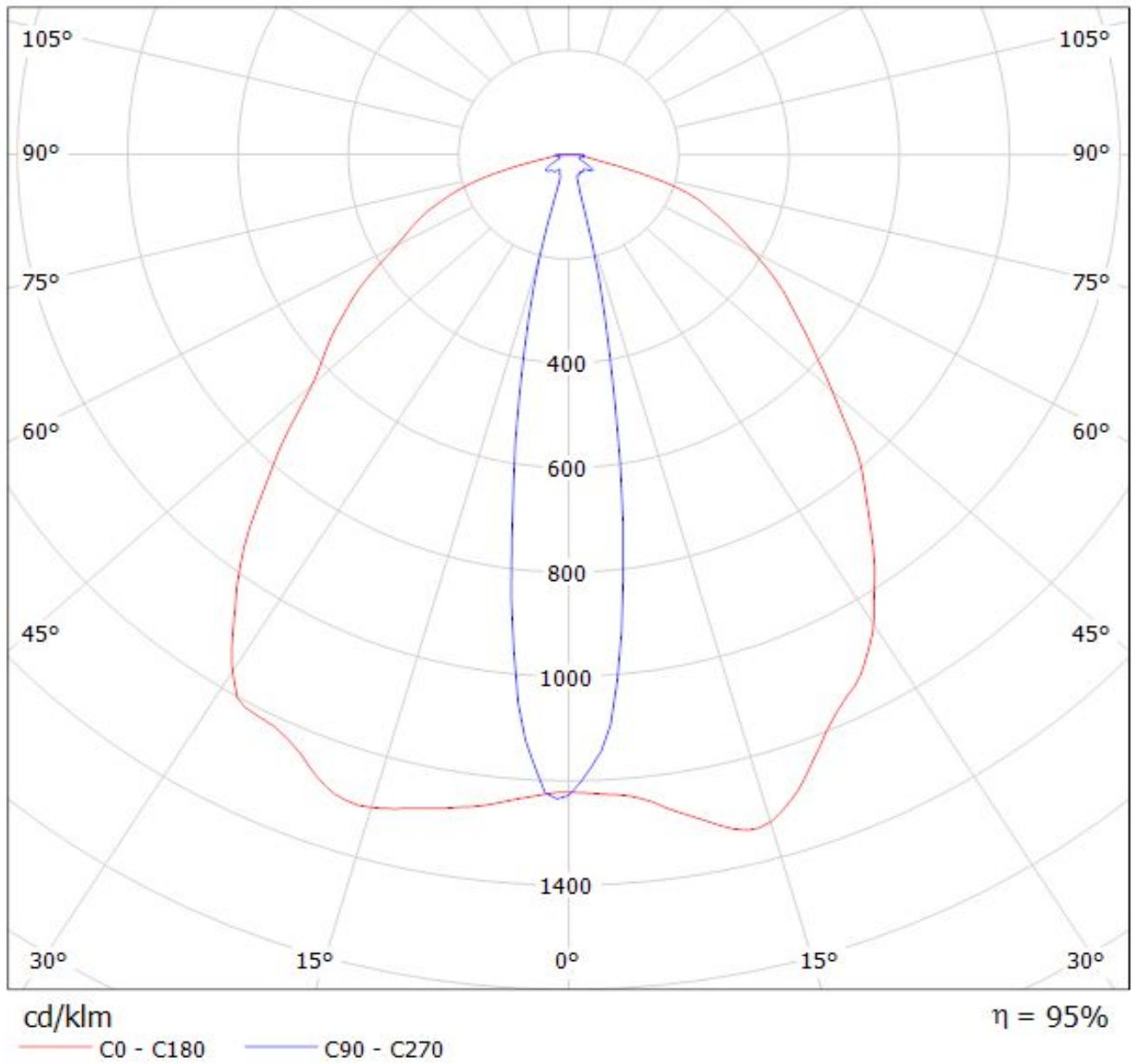

Luminaire: Ledil Oy CA12764/CA12838_FLARE-MINI-A (Luxeon Rebel ES 92lm @ 250mA) Efficiency=94%
Lamps: 1 x Luxeon Rebel ES 92lm @ 250mA

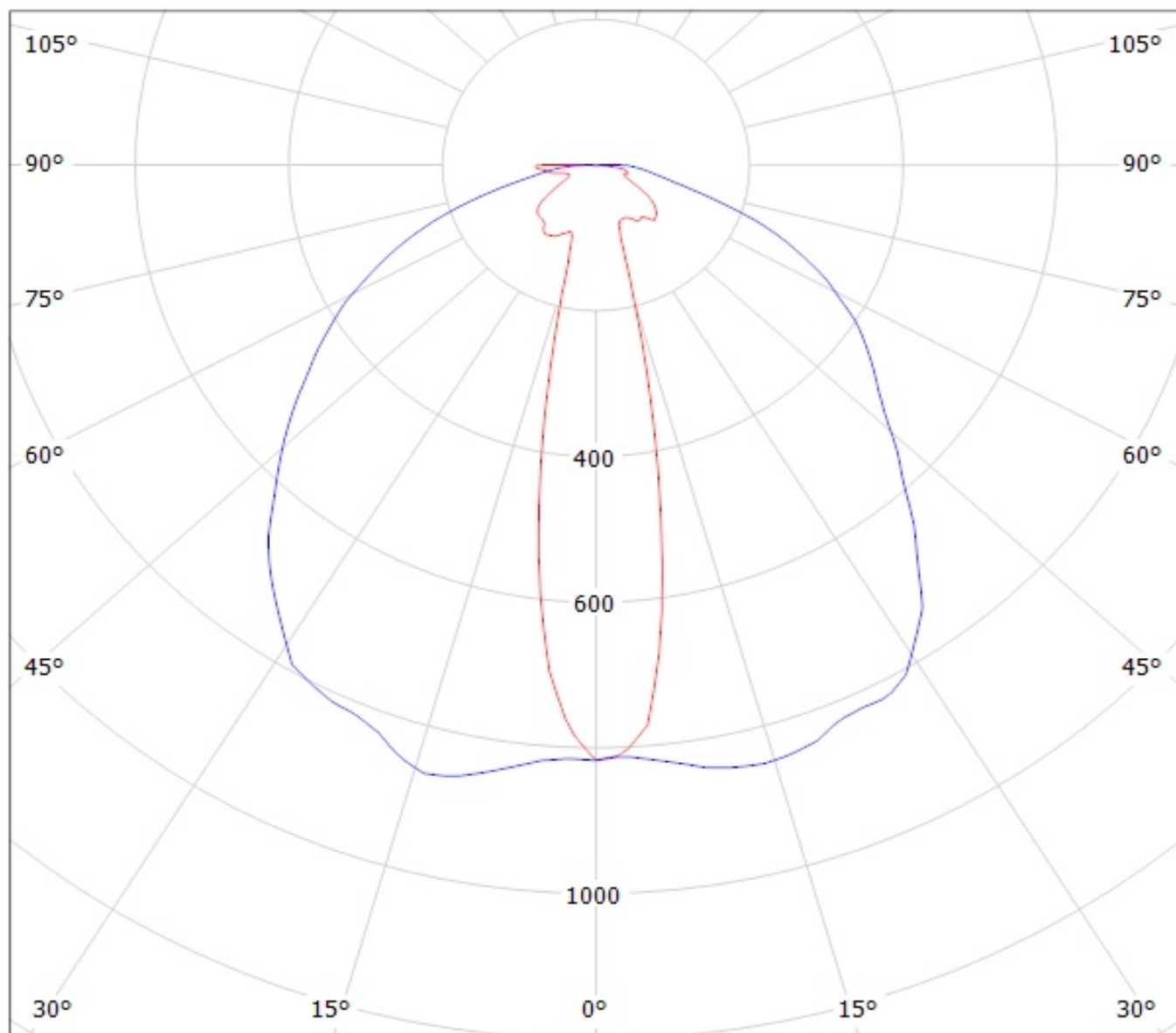

cd/klm

— C0 - C180 — C90 - C270

Luminaire: LEDiL Oy CA12838_FLARE-MINI-A-PIN_(LUXEON_T)_1 Eff.92.5%
Lamps: 1 x LUXEON T (74lm@250mA)

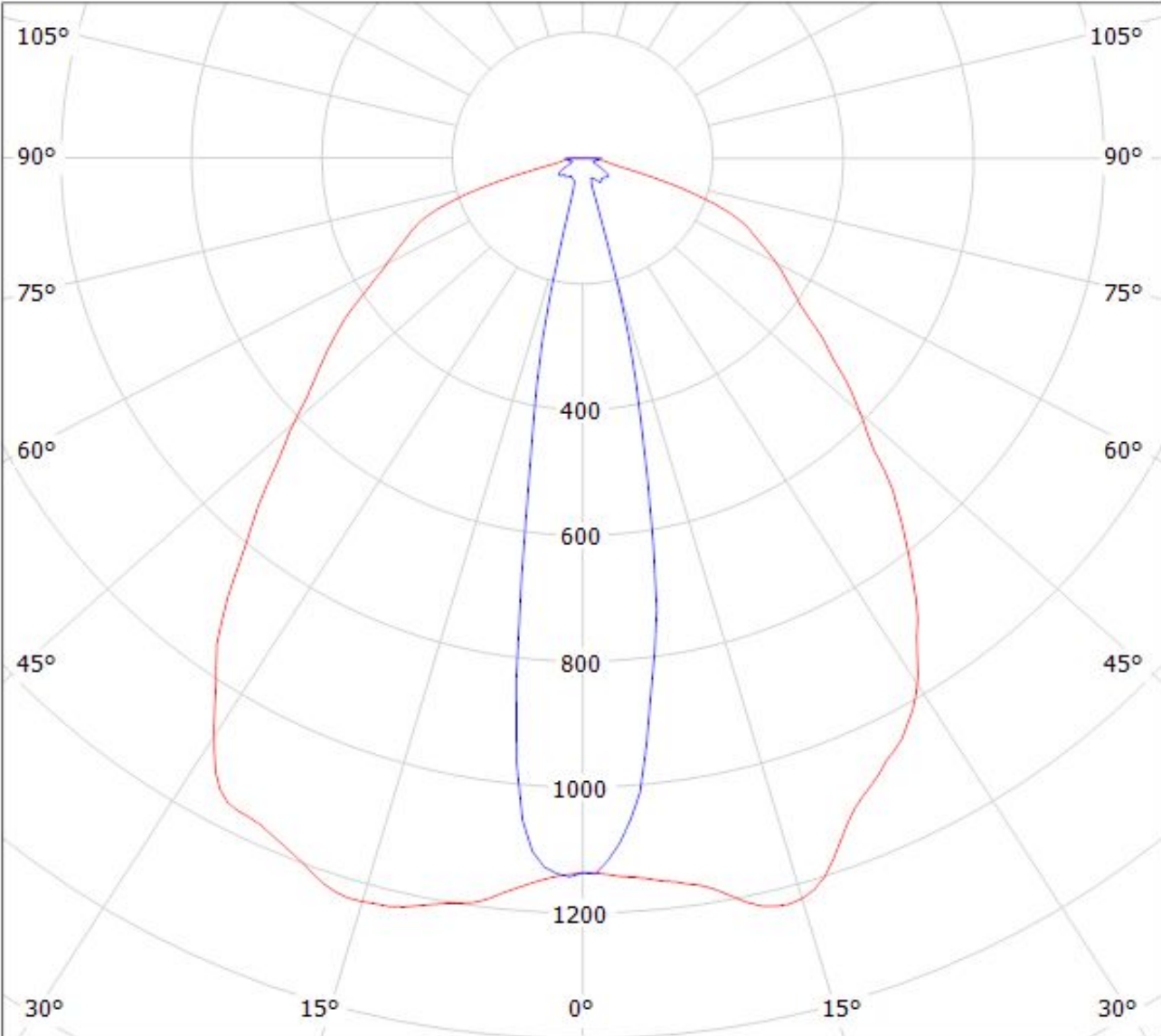

cd/klm

— C0 - C180 — C90 - C270

$\eta = 92\%$

Luminaire: Ledil Oy CA12838_FLARE-MINI-A-PIN_(Luxeon_TX)
Lamps: 1 x Luxeon TX (77.6lm @ 250mA) P=0.7W I=250mA

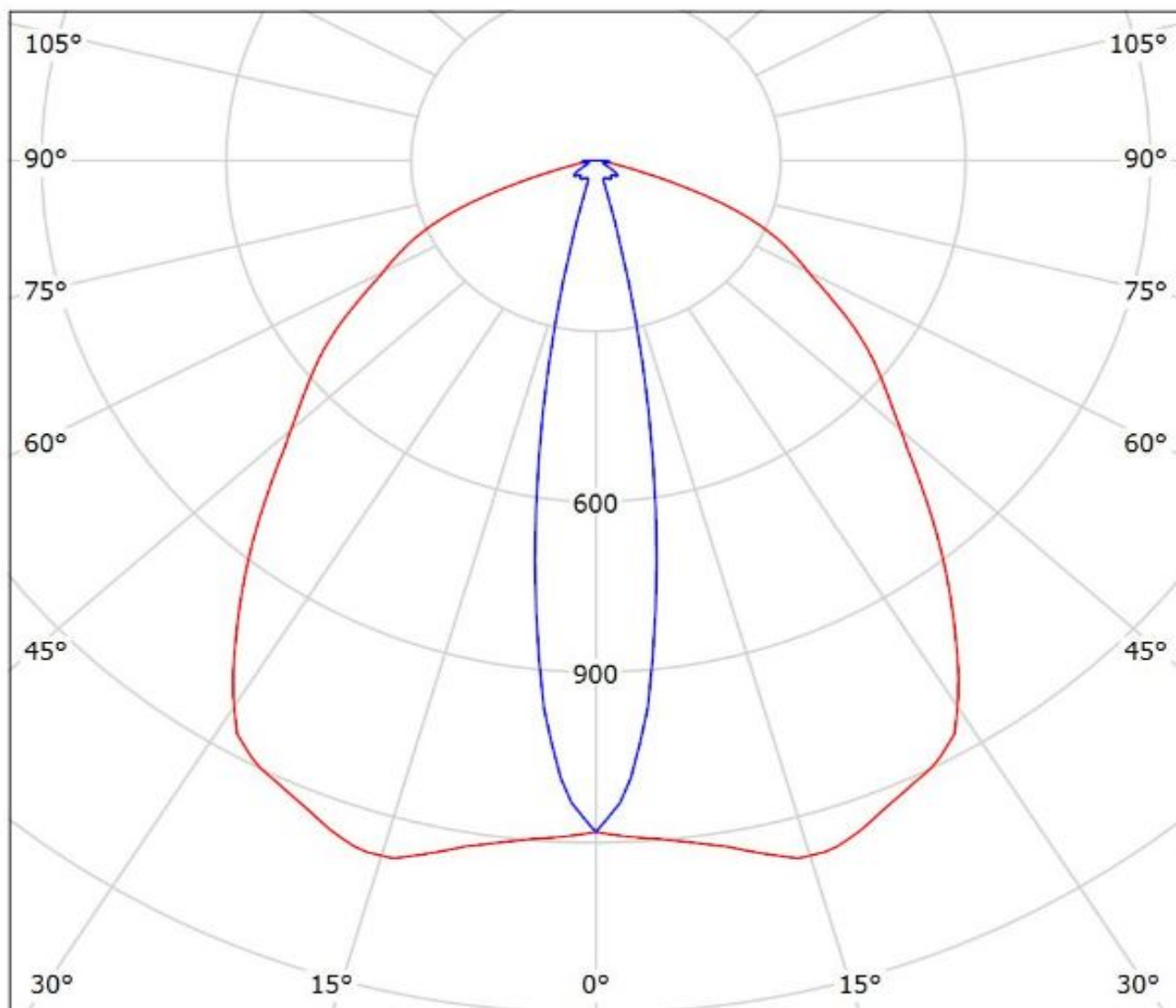

cd/klm
— C0 - C180 — C90 - C270

$\eta = 95\%$

Luminaire: Ledil Oy CA12764&CA12838_FLARE-MINI-A (Nichia NCS19 95lm @ 250mA) Efficiency=94%
Lamps: 1 x Nichia NCS19 95lm @ 250mA

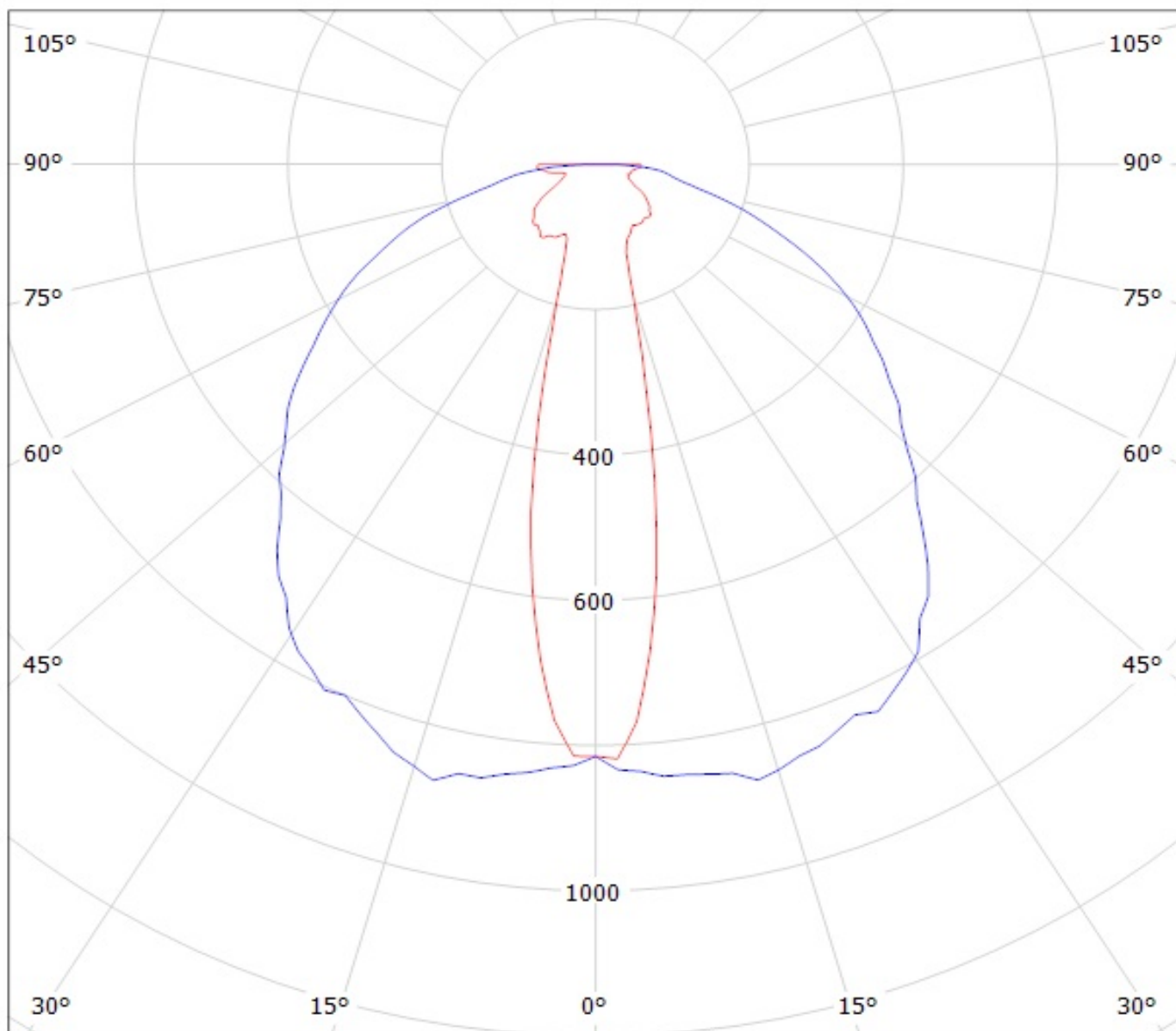

cd/klm

— C0 - C180 — C90 - C270

Luminaire: Ledil Oy CA12838_Flare_Mini-A-Pin_(NCSxx19B) Efficiency=94%
Lamps: 1 x Nichia NCSxx19B (NCSL119BE) 88.1lm @ 250mA CCT=3000K P=0.8W I=250mA

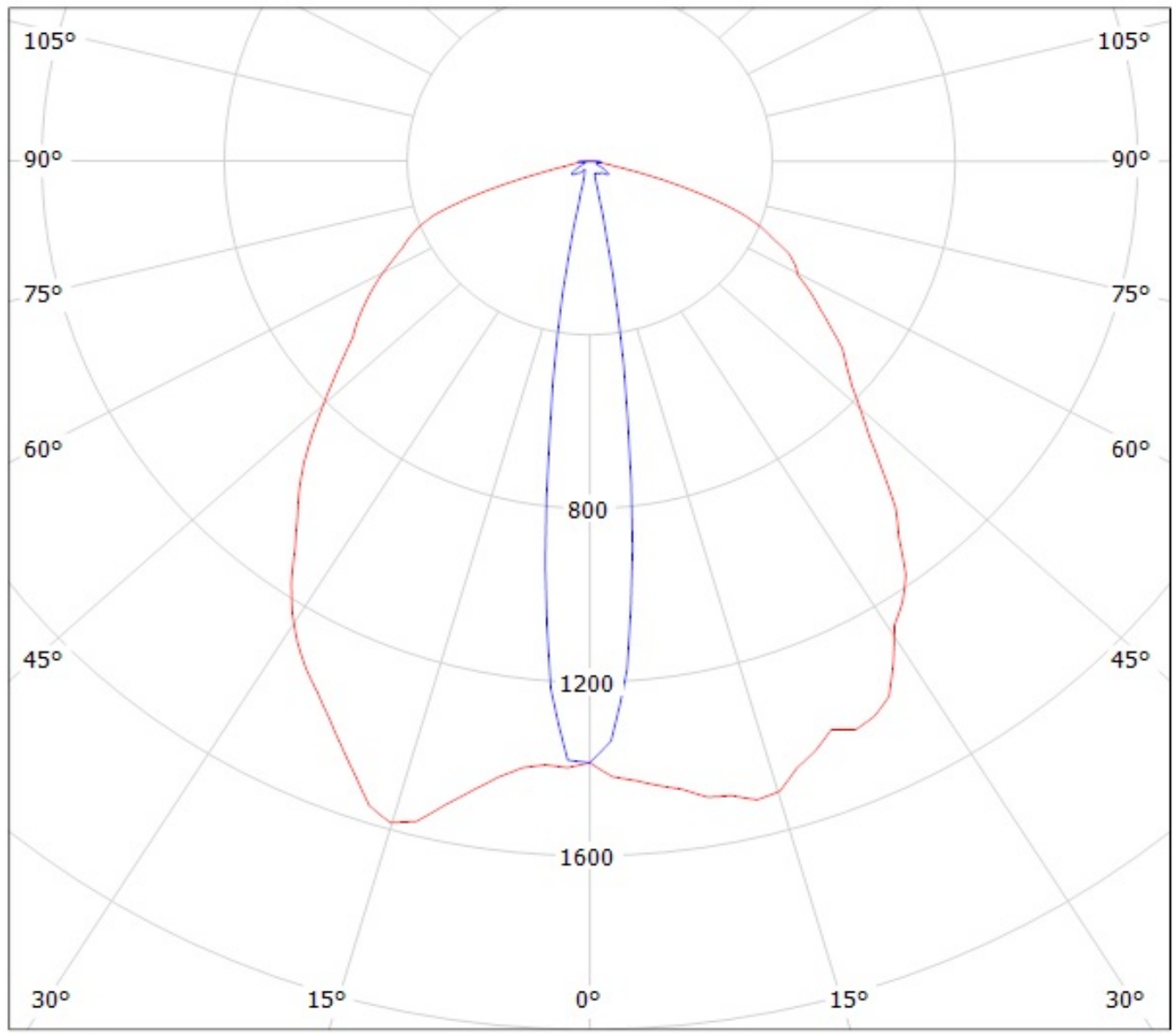

cd/klm

— C0 - C180 — C90 - C270

Luminaire: LEDiL Oy CA12838_FLARE-MINI-A-PIN_(NVSL219CE)
Lamps: 1 x Nichia_NVSL219CE_101.227lm@250mA_P=0.713404W_I=0.25A

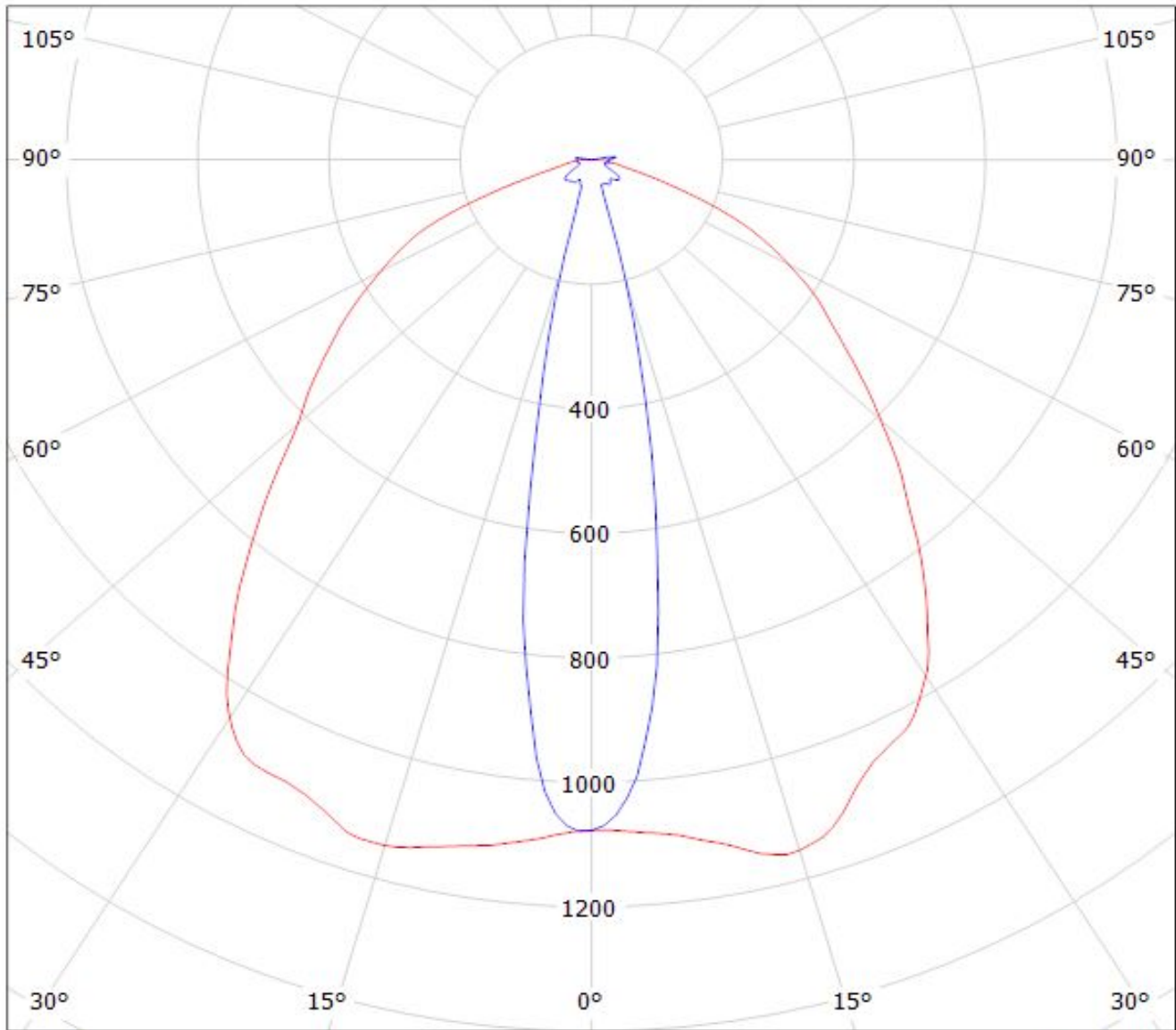

cd/klm

$\eta = 95\%$

— C0 - C180 — C90 - C270

Luminaire: Ledil Oy CA12764&CA12838_FLARE-MINI-A (Osram Square PC 88lm @ 250mA) Efficiency=94%
Lamps: 1 x Osram Square PC 88lm @ 250mA

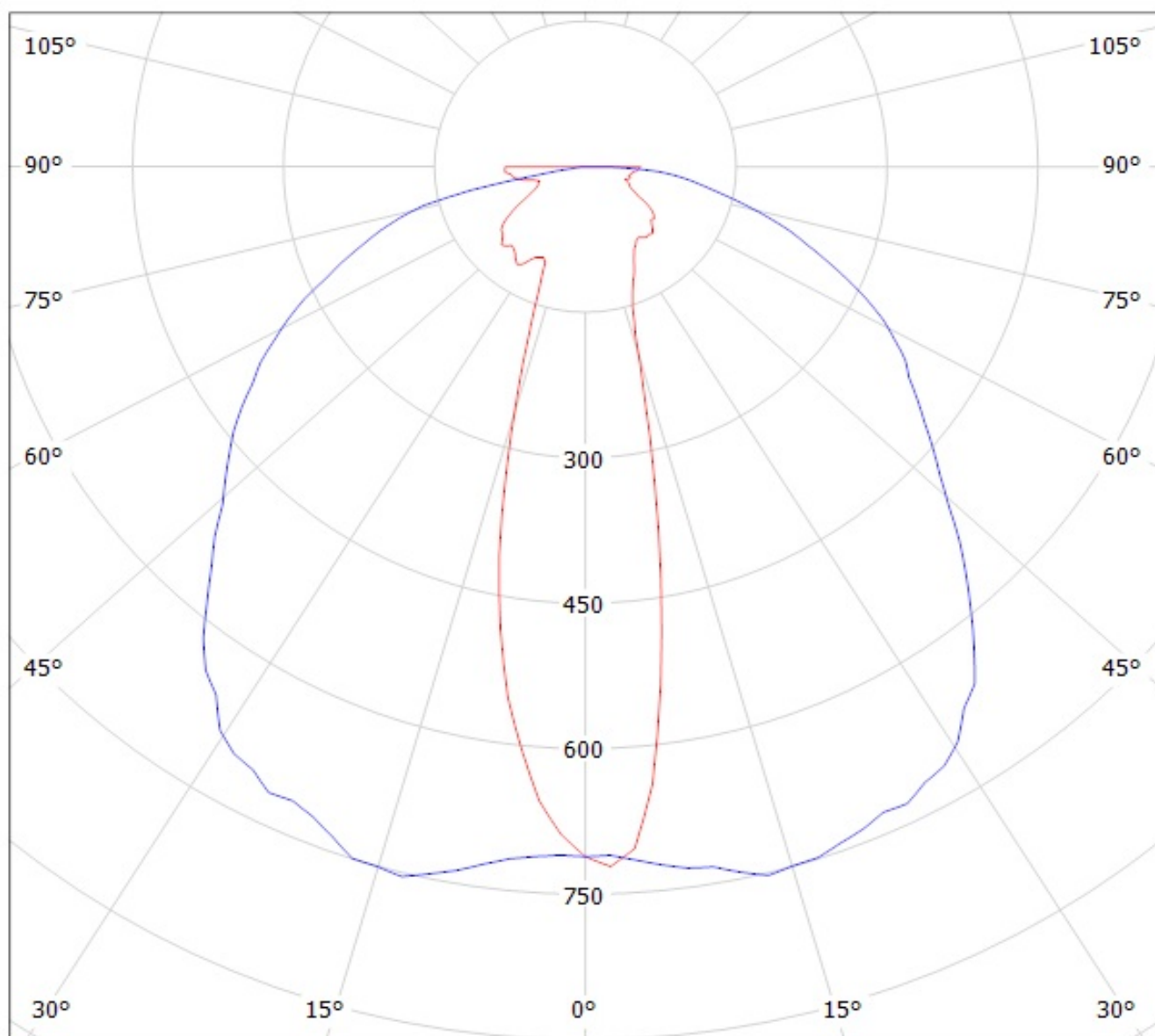

cd/klm

— C0 - C180

— C90 - C270

Luminaire: Ledil Oy CA12764/CA12838_FLARE-MINI-A (Osram OSL80 84lm @ 250mA) Efficiency=93%
Lamps: 1 x Osram OSL80 84lm @ 250mA

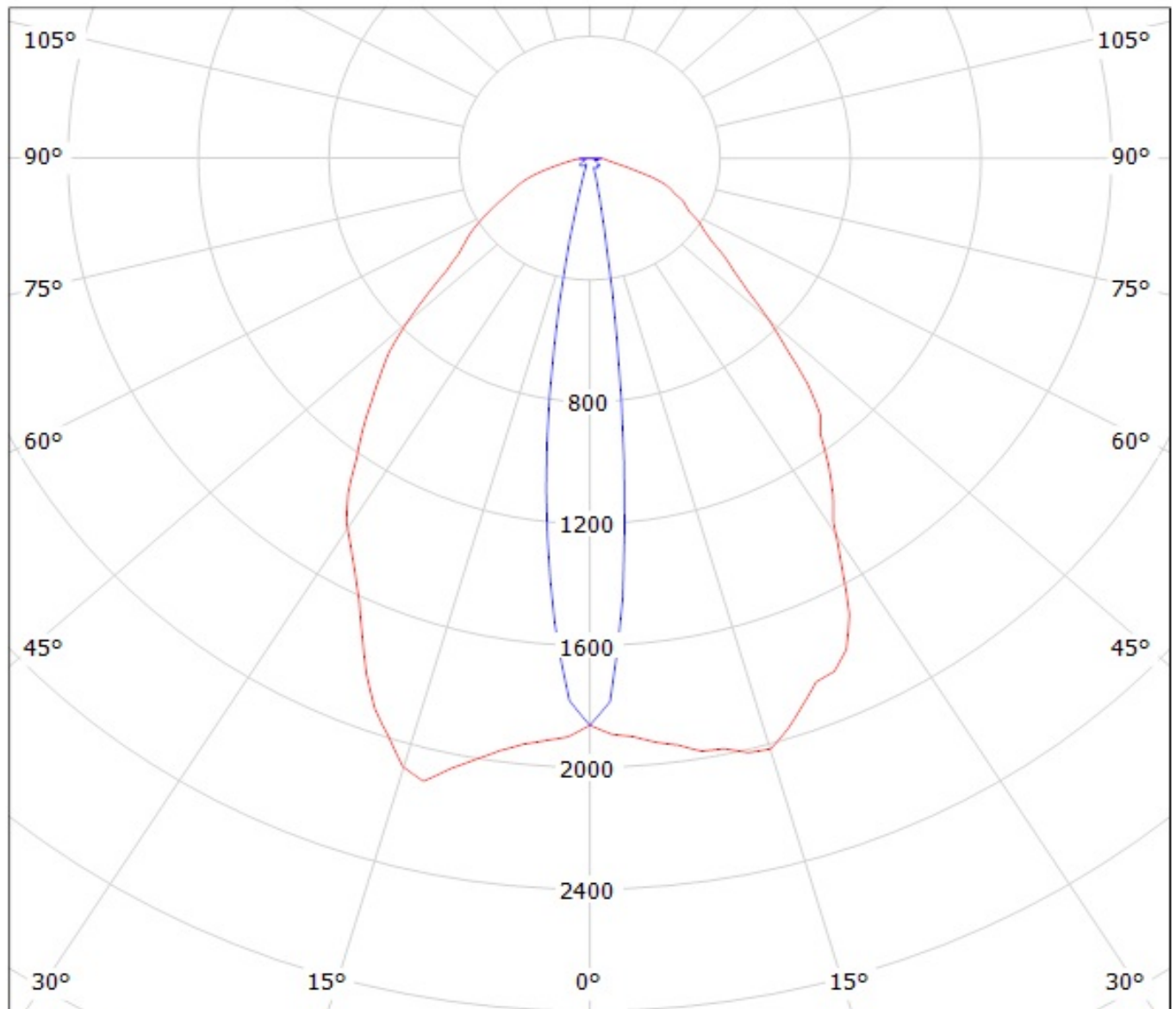

cd/klm

— C0 - C180

— C90 - C270

Luminaire: Ledil Oy C12763/C12837_FLARE-MINI-A (Osram OSL150 95lm @ 250mA) Efficiency=93%
Lamps: 1 x Osram OSL150 95lm @ 250mA

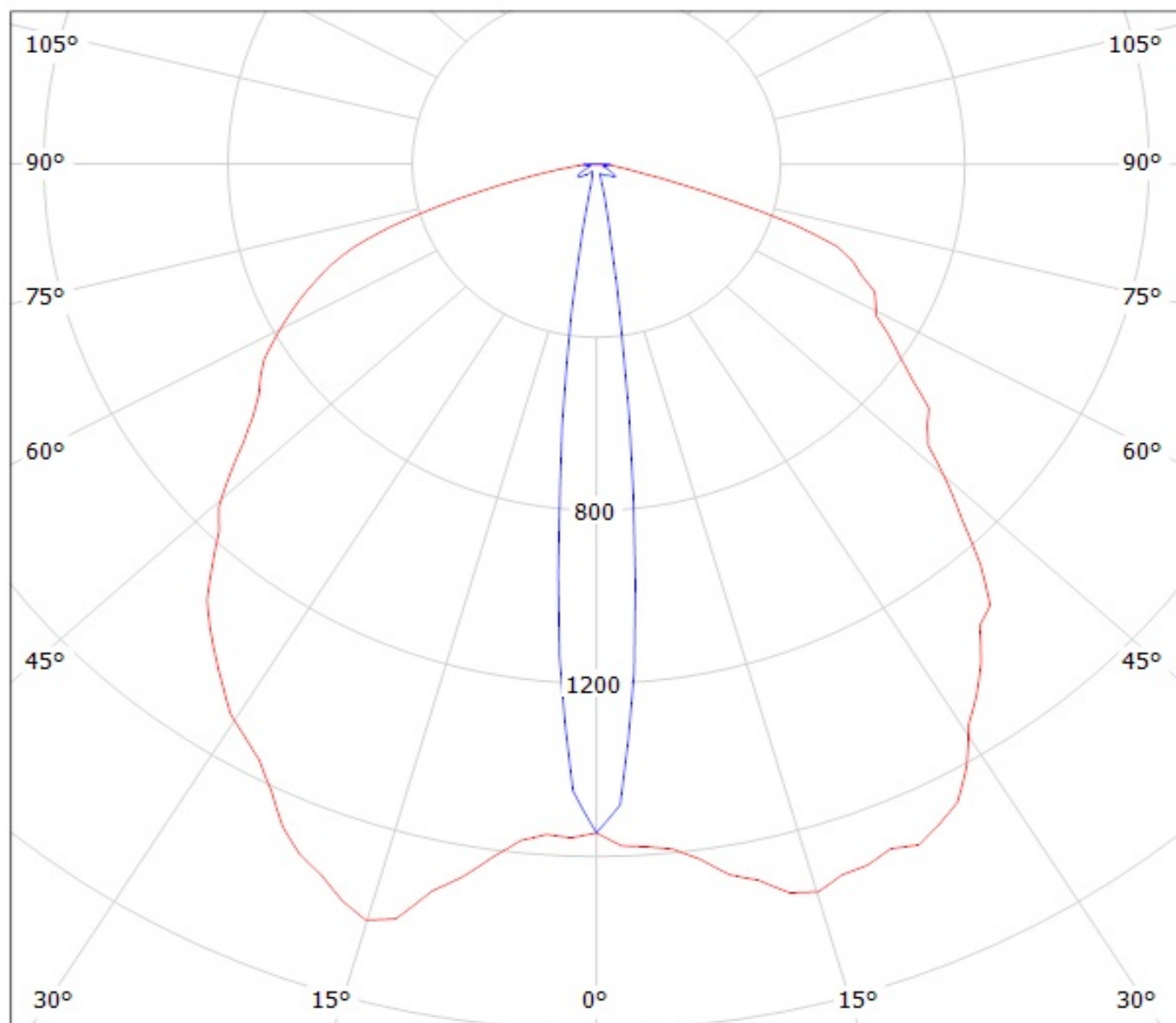

cd/klm

— C0 - C180 — C90 - C270

Luminaire: LEDil Oy CA12838_FLARE-MINI-A-PIN_(LH351Z)

Lamps: 1 x Samsung LH351Z (90.14lm @ 250mA) CCT=6500K P=0.7W I=250mA

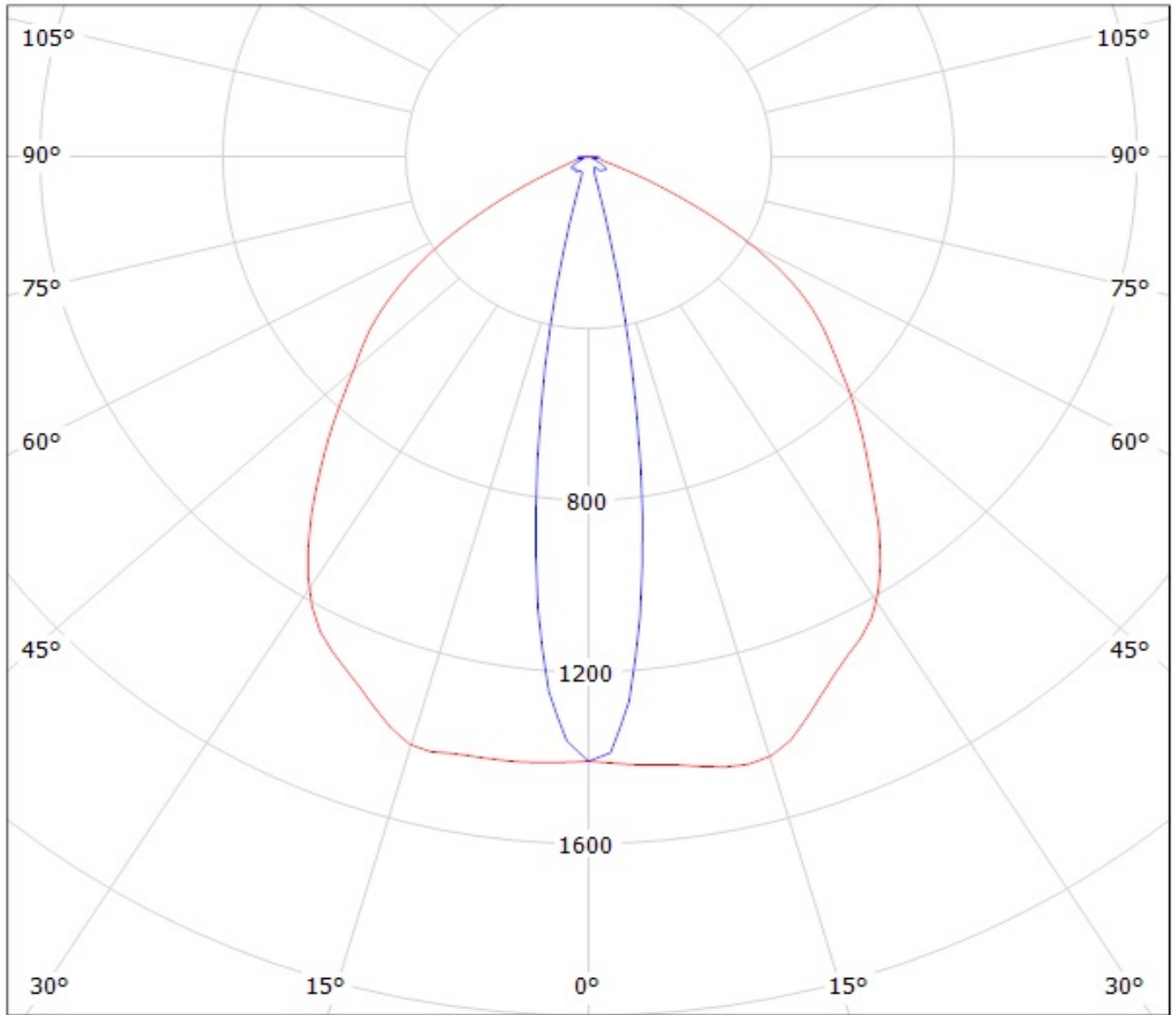

cd/klm

— C0 - C180

— C90 - C270

$\eta = 94\%$

NOTE: The typical divergence will be changed by different color, chip size and chip position tolerance. The typical total divergence is the full angle measured where the luminous intensity is half of the peak value.