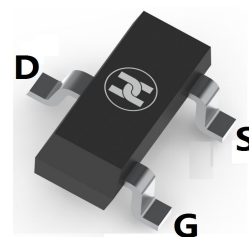
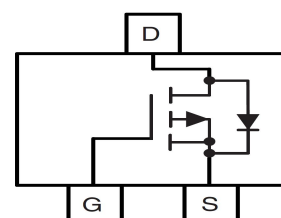


**P-Channel Power MOSFET**
**FEATURES**

- $V_{DS} = -20V, R_{DS(ON)} \leq 65m\Omega @ V_{GS} = -4.5V, I_D = -3.7A$
- Ultra Low On-Resistance
- P-Channel MOSFET
- Fast Switching


**SOT-23**

**MECHANICAL DATA**

- Case: SOT-23
- Case Material: Molded Plastic. UL flammability
- Classification Rating: 94V-0
- Weight: 0.008 grams (approximate)

**Absolute Maximum Ratings**

	Parameter	Max.	Units
$V_{DS}$	Drain- Source Voltage	-20	V
$I_D @ T_A = 25^\circ C$	Continuous Drain Current, $V_{GS} @ -4.5V$	-3.7	A
$I_D @ T_A = 70^\circ C$	Continuous Drain Current, $V_{GS} @ -4.5V$	-2.2	
$I_{DM}$	Pulsed Drain Current ①	-22	
$P_D @ T_A = 25^\circ C$	Power Dissipation	1.3	W
$P_D @ T_A = 70^\circ C$	Power Dissipation	0.8	
	Linear Derating Factor	0.01	
$E_{AS}$	Single Pulse Avalanche Energy④	11	mJ
$V_{GS}$	Gate-to-Source Voltage	$\pm 12$	V
$T_J, T_{STG}$	Junction and Storage Temperature Range	-55 to + 150	$^\circ C$

**Thermal Resistance**

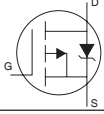
	Parameter	Typ.	Max.	Units
$R_{\theta JA}$	Maximum Junction-to-Ambient③	75	100	$^\circ C/W$

**Electrical Characteristics @  $T_J = 25^\circ C$  (unless otherwise specified)**

	Parameter	Min.	Typ.	Max.	Units	Conditions
$V_{(BR)DSS}$	Drain-to-Source Breakdown Voltage	-20	—	—	V	$V_{GS} = 0V, I_D = -250\mu A$
$\Delta V_{(BR)DSS}/\Delta T_J$	Breakdown Voltage Temp. Coefficient	—	-0.009	—	V/ $^\circ C$	Reference to $25^\circ C, I_D = -1mA$ ②
$R_{DS(on)}$	Static Drain-to-Source On-Resistance	—	0.050	0.065	$\Omega$	$V_{GS} = -4.5V, I_D = -3.7A$ ②
		—	0.080	0.135		$V_{GS} = -2.5V, I_D = -3.1A$ ②
$V_{GS(th)}$	Gate Threshold Voltage	-0.40	-0.55	-1.2	V	$V_{DS} = V_{GS}, I_D = -250\mu A$
$g_{fs}$	Forward Transconductance	6.0	—	—	S	$V_{DS} = -10V, I_D = -3.7A$ ②
$I_{DSS}$	Drain-to-Source Leakage Current	—	—	-1.0	$\mu A$	$V_{DS} = -20V, V_{GS} = 0V$
		—	—	-25		$V_{DS} = -20V, V_{GS} = 0V, T_J = 70^\circ C$
$I_{GSS}$	Gate-to-Source Forward Leakage	—	—	-100	nA	$V_{GS} = -12V$
	Gate-to-Source Reverse Leakage	—	—	100		$V_{GS} = 12V$
$Q_g$	Total Gate Charge	—	8.0	12	nC	$I_D = -3.7A$
$Q_{gs}$	Gate-to-Source Charge	—	1.2	1.8		$V_{DS} = -10V$
$Q_{gd}$	Gate-to-Drain ("Miller") Charge	—	2.8	4.2		$V_{GS} = -5.0V$ ②
$t_{d(on)}$	Turn-On Delay Time	—	350	—	ns	$V_{DD} = -10V$
$t_r$	Rise Time	—	48	—		$I_D = -3.7A$
$t_{d(off)}$	Turn-Off Delay Time	—	588	—		$R_G = 89\Omega$
$t_f$	Fall Time	—	381	—		$R_D = 2.7\Omega$
$C_{iss}$	Input Capacitance	—	633	—	pF	$V_{GS} = 0V$
$C_{oss}$	Output Capacitance	—	145	—		$V_{DS} = -10V$
$C_{rss}$	Reverse Transfer Capacitance	—	110	—		$f = 1.0MHz$

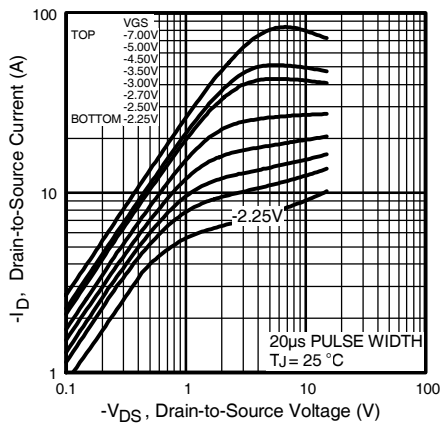
# IRLML6402

## Source-Drain Ratings and Characteristics

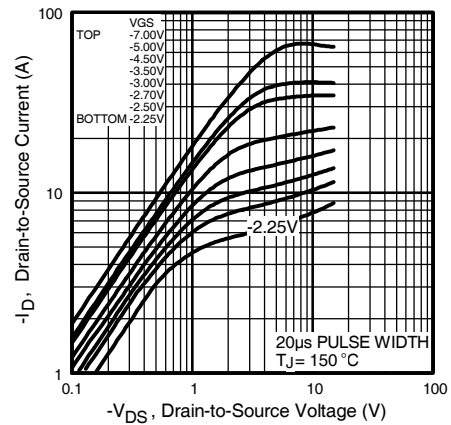
	Parameter	Min.	Typ.	Max.	Units	Conditions
$I_S$	Continuous Source Current (Body Diode)	—	—	-1.3	A	MOSFET symbol showing the integral reverse p-n junction diode. 
$I_{SM}$	Pulsed Source Current (Body Diode) ①	—	—	-22		
$V_{SD}$	Diode Forward Voltage	—	—	-1.2	V	$T_J = 25^\circ\text{C}$ , $I_S = -1.0\text{A}$ , $V_{GS} = 0\text{V}$ ②
$t_{rr}$	Reverse Recovery Time	—	29	43	ns	$T_J = 25^\circ\text{C}$ , $I_F = -1.0\text{A}$
$Q_{rr}$	Reverse Recovery Charge	—	11	17	nC	$di/dt = -100\text{A}/\mu\text{s}$ ②

**Notes:**

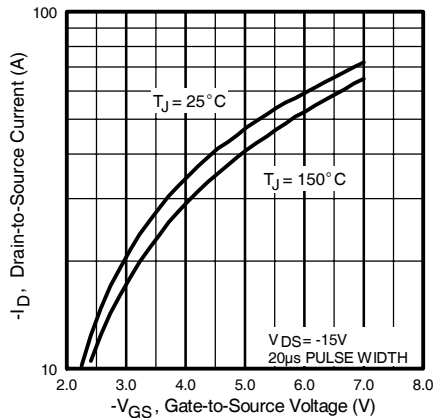
- ① Repetitive rating; pulse width limited by max. junction temperature.
- ② Pulse width  $\leq 400\mu\text{s}$ ; duty cycle  $\leq 2\%$ .
- ③ Surface mounted on 1" square single layer 1oz. copper FR4 board, steady state.
- ④ Starting  $T_J = 25^\circ\text{C}$ ,  $L = 1.65\text{mH}$   
 $R_G = 25\Omega$ ,  $I_{AS} = -3.7\text{A}$ .



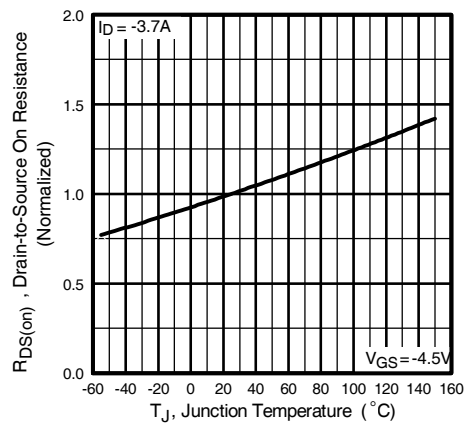
**Fig 1.** Typical Output Characteristics



**Fig 2.** Typical Output Characteristics

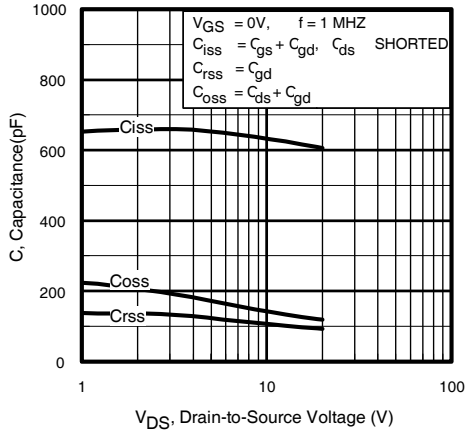


**Fig 3.** Typical Transfer Characteristics

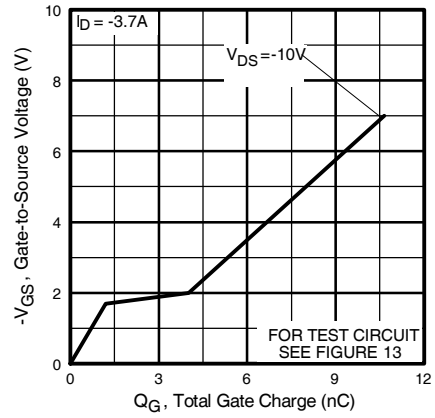


**Fig 4.** Normalized On-Resistance Vs. Temperature

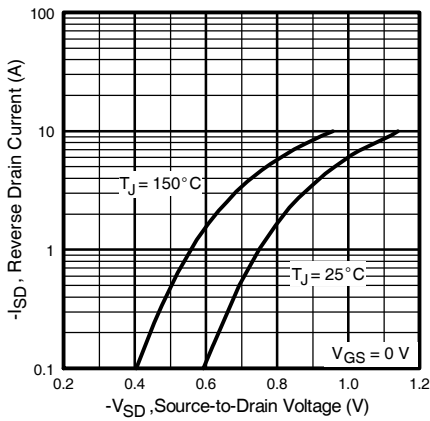
**IRLML6402**



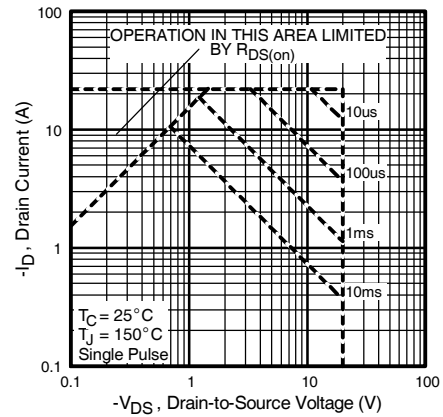
**Fig 5.** Typical Capacitance Vs. Drain-to-Source Voltage



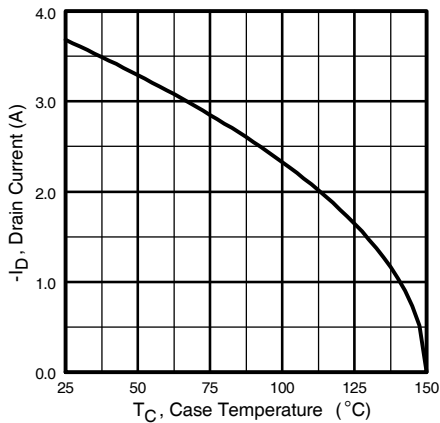
**Fig 6.** Typical Gate Charge Vs. Gate-to-Source Voltage



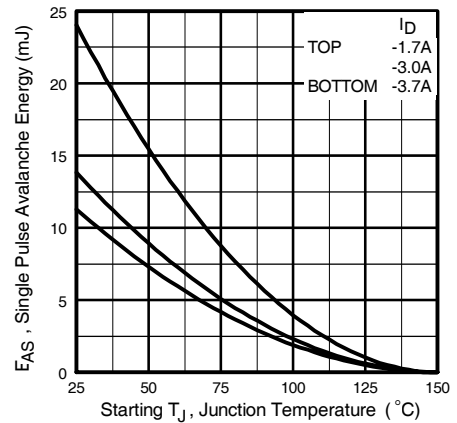
**Fig 7.** Typical Source-Drain Diode Forward Voltage



**Fig 8.** Maximum Safe Operating Area

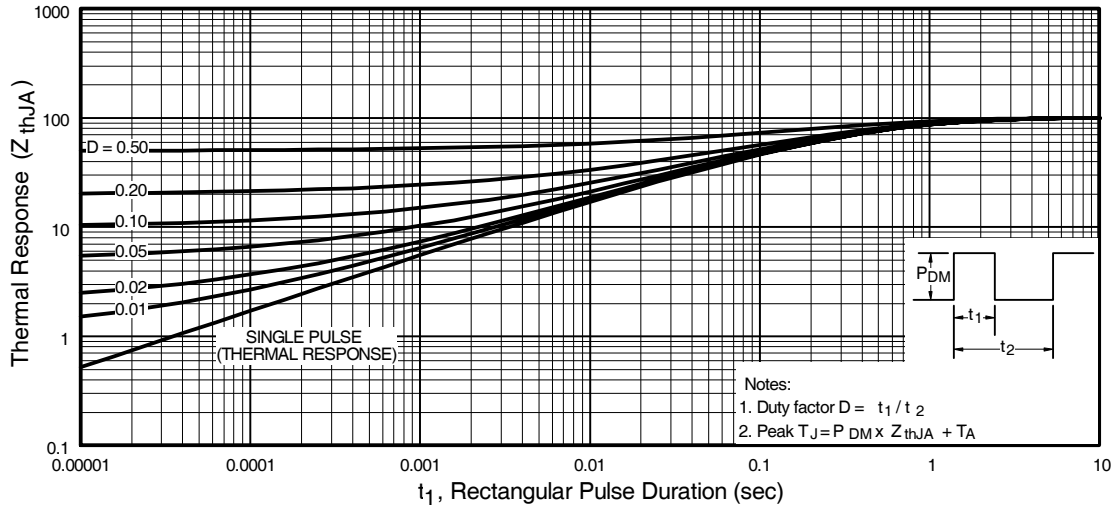


**Fig 9.** Maximum Drain Current Vs. Case Temperature

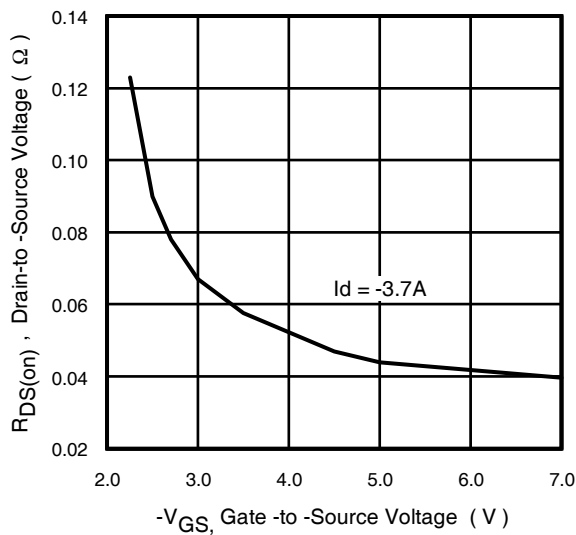


**Fig 10.** Maximum Avalanche Energy Vs. Drain Current

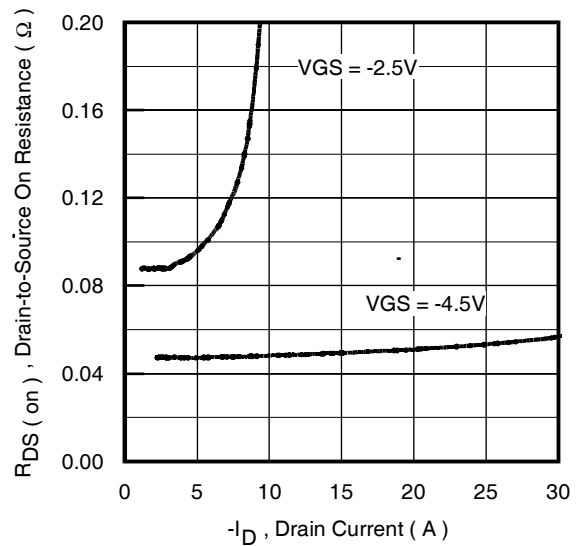
**IRLML6402**



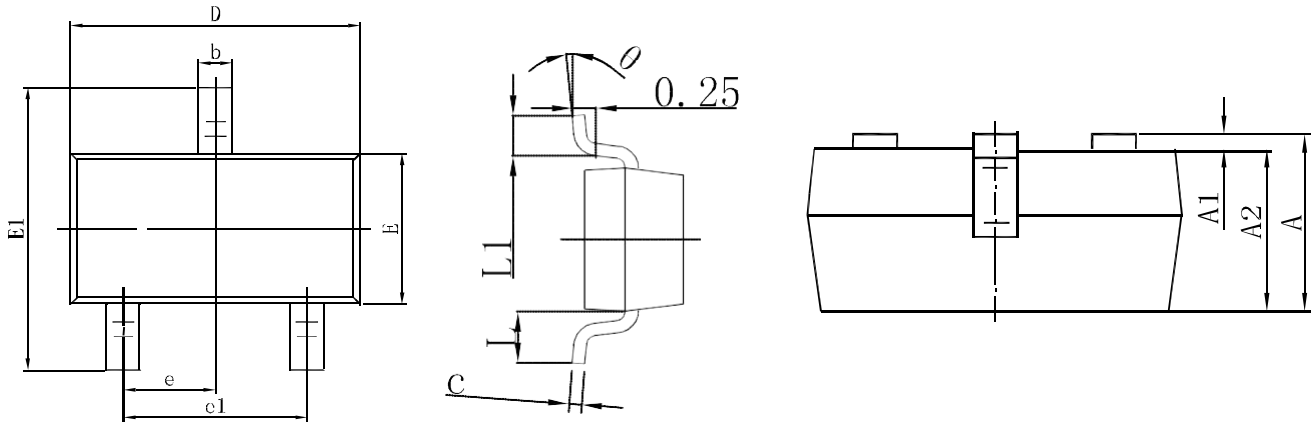
**Fig 11.** Maximum Effective Transient Thermal Impedance, Junction-to-Ambient



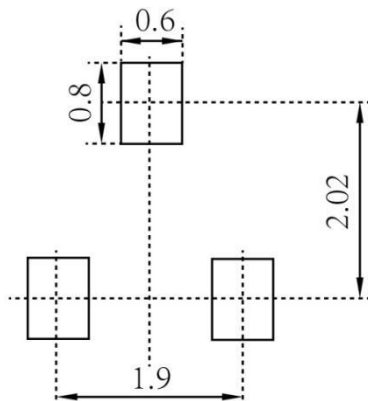
**Fig 12.** Typical On-Resistance Vs. Gate Voltage



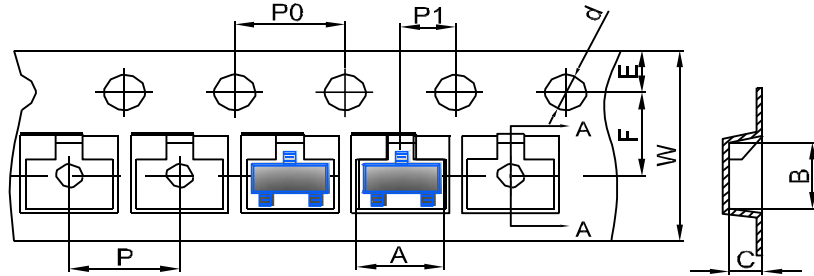
**Fig 13.** Typical On-Resistance Vs. Drain Current

**P-Channel Power MOSFET**
**SOT-23 Package Outline Dimensions**


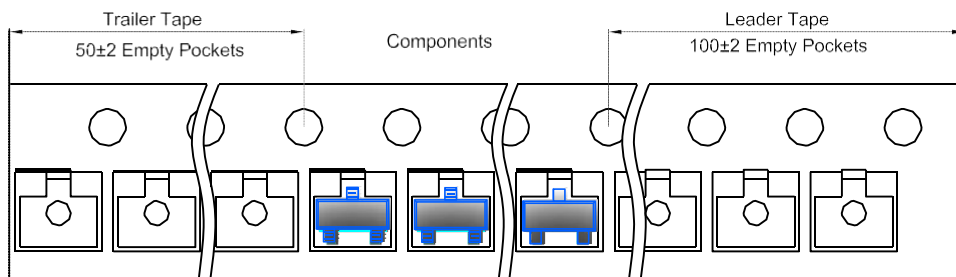
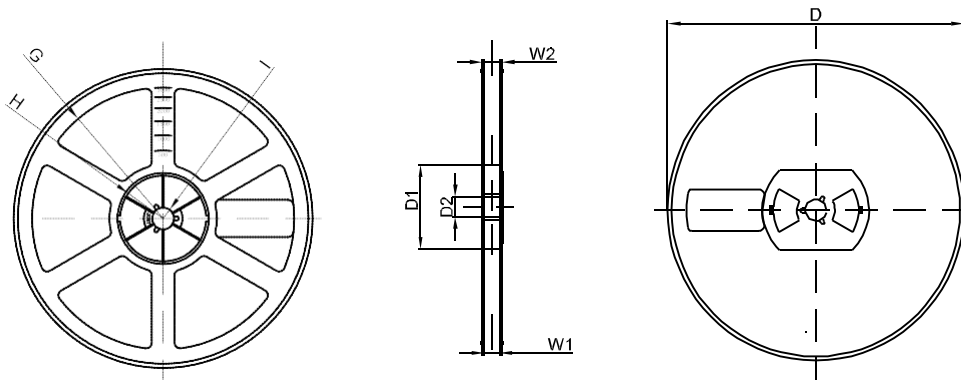
Symbol	Dimensions In Millimeters		Dimensions In Inches	
	Min.	Max.	Min.	Max.
A	0.900	1.150	0.035	0.045
A1	0.000	0.100	0.000	0.004
A2	0.900	1.050	0.035	0.041
b	0.300	0.500	0.012	0.020
c	0.080	0.150	0.003	0.006
D	2.800	3.000	0.110	0.118
E	1.200	1.400	0.047	0.055
E1	2.250	2.550	0.089	0.100
e	0.950 TYP		0.037 TYP	
e1	1.800	2.000	0.071	0.079
L	0.550 REF		0.022 REF	
L1	0.300	0.500	0.012	0.020
$\theta$	0°	8°	0°	8°

**SOT-23 Suggested Pad Layout**

**Note:**

1. Controlling dimension: in millimeters
2. General tolerance:  $\pm 0.05\text{mm}$
3. The pad layout is for reference purposes only

**P-Channel Power MOSFET**
**SOT-23 Tape and Reel**
**SOT-23 Embossed Carrier Tape**


DIMENSIONS ARE IN MILLIMETER										
TYPE	A	B	C	d	E	F	P0	P	P1	W
SOT-23	3.15	2.77	1.22	Ø1.50	1.75	3.50	4.00	4.00	2.00	8.00
TOLERANCE	±0.1	±0.1	±0.1	±0.1	±0.1	±0.1	±0.1	±0.1	±0.1	±0.1

**SOT-23 Tape Leader and Trailer**

**SOT-23 Reel**


DIMENSIONS ARE IN MILLIMETER								
REEL OPTION	D	D1	D2	G	H	I	W1	W2
7" DIA	Ø178	54.40	13.00	R78	R25.60	R6.50	9.50	12.30
TOLERANCE	±2	±1	±1	±1	±1	±1	±1	±1