



92x92x25 mm

San Ace 92W 9WL type   

General Specifications

- Material Frame: Aluminum (Black coating), Impeller: Plastic (Flammability: UL 94V-1)
- Expected life See the table below. (L10 life: 90% survival rate for continuous operation in indoor free air at 60°C, rated voltage)
Expected life at 40°C is for reference only.
- Motor protection function Locked rotor burnout protection, Reverse polarity protection
For details, please refer to p. 599.
- Dielectric strength 50/60 Hz, 500 VAC, for 1 minute (between lead wire conductors and frame)
- Insulation resistance 10 MΩ or more with a 500 VDC megger (between lead wire conductors and frame)
- Sound pressure level (SPL) At 1 m away from the air inlet
- Storage temperature -30 to +70°C (Non-condensing)
- Lead wire ⊕Red ⊖Black (Sensor) Yellow (Control) Brown
(For models without PWM control function, there is no speed control wiring.)
- Mass 170 g
- Ingress protection IP68

Specifications

The models listed below **have pulse sensors with PWM control function.**

Model no.	Rated voltage [V]	Operating voltage range [V]	PWM duty cycle* [%]	Rated current [A]	Rated input [W]	Rated speed [min ⁻¹]	Max. airflow [m ³ /min] [CFM]		Max. static pressure [Pa] [inchH ₂ O]		SPL [dB (A)]	Operating temperature [°C]	Expected life [h]				
9WL0912P4J001	12	10.8 to 13.2	100	0.42	5.04	5000	2.2	77.7	105	0.42	44	-20 to +70	180000/60°C (215000/40°C)				
			20	0.04	0.48	1200	0.52	18.4	6.04	0.024	11						
9WL0912P4G001			100	0.3	3.6	4400	1.93	68.2	81	0.33	40						
			20	0.04	0.48	1000	0.43	15.1	4.18	0.016	8						
9WL0912P4S001			100	0.22	2.64	3850	1.69	59.7	62.1	0.25	37						
			30	0.04	0.48	1400	0.61	21.5	8.21	0.032	13						
9WL0912P4H001			100	0.15	1.8	3150	1.38	48.7	41.6	0.17	32						
			30	0.04	0.48	1100	0.48	16.9	5.07	0.02	9						
9WL0924P4J001			24	21.6 to 26.4	100	0.21	5.04	5000	2.2	77.7	105			0.42	44	-20 to +70	180000/60°C (215000/40°C)
					20	0.02	0.48	1100	0.48	16.9	5.07			0.02	9		
9WL0924P4S001					100	0.11	2.64	3850	1.69	59.7	62.1			0.25	37		
					30	0.02	0.48	1300	0.57	20.1	7.08			0.028	12		
9WL0924P4H001	100	0.07			1.68	3150	1.38	48.7	41.6	0.17	32						
	30	0.02			0.48	1000	0.43	15.1	4.18	0.016	8						

* PWM input frequency is 25 kHz; models without specifications at 0% PWM duty cycle have zero fan speed at 0%.

The models listed below **have pulse sensors.**

Model no.	Rated voltage [V]	Operating voltage range [V]	Rated current [A]	Rated input [W]	Rated speed [min ⁻¹]	Max. airflow [m ³ /min] [CFM]		Max. static pressure [Pa] [inchH ₂ O]		SPL [dB (A)]	Operating temperature [°C]	Expected life [h]
9WL0912M4001	12	10.2 to 13.8	0.08	0.96	2400	1.05	37.1	24.1	0.097	24	-20 to +70	180000/60°C (215000/40°C)
9WL0924F4001	24	20.4 to 27.6	0.05	1.2	2800	1.22	43.1	32.8	0.13	29		
9WL0924M4001			0.04	0.96	2400	1.05	37.1	24.1	0.097	24		

Note: Sensor and control options are available for selection. Refer to the table on p. 638.

Airflow - Static Pressure Characteristics / PWM Duty - Speed Characteristics Example

9WL0912P4J001 With pulse sensor with PWM control function

PWM duty cycle

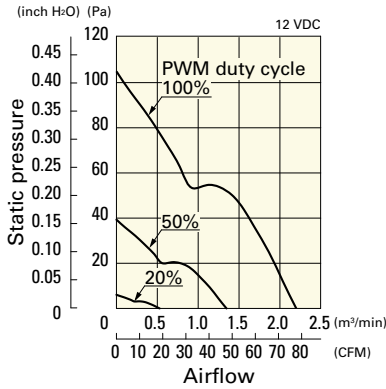

Operating voltage range

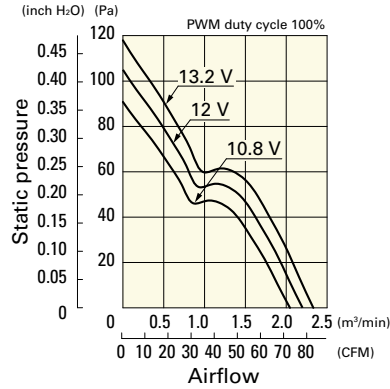

PWM duty - Speed characteristics example

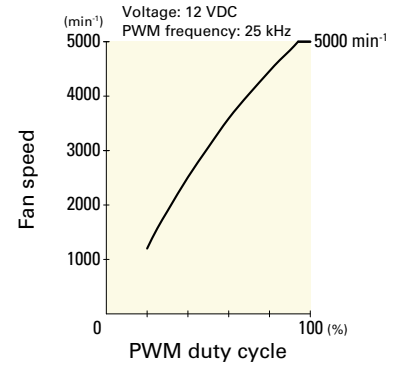

9WL0912P4G001 With pulse sensor with PWM control function

PWM duty cycle

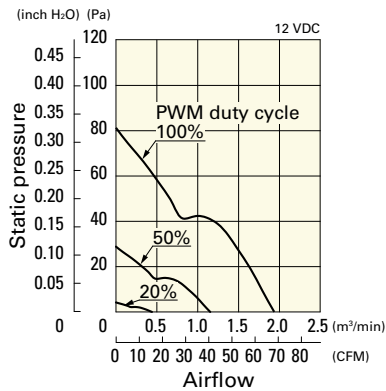

Operating voltage range

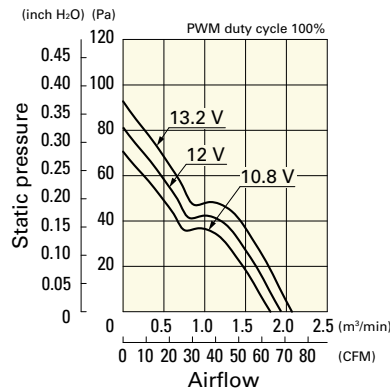

PWM duty - Speed characteristics example

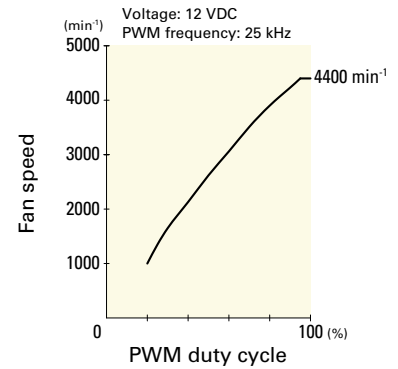

9WL0912P4S001 With pulse sensor with PWM control function

PWM duty cycle

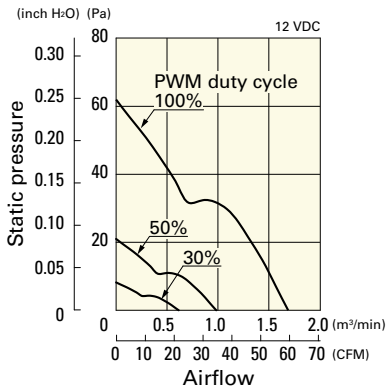

Operating voltage range

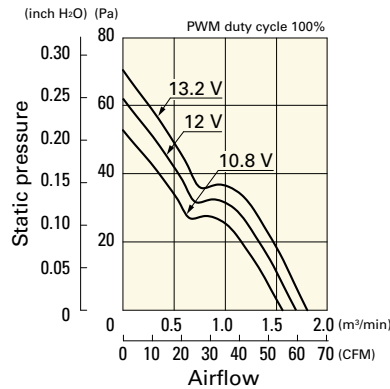

PWM duty - Speed characteristics example

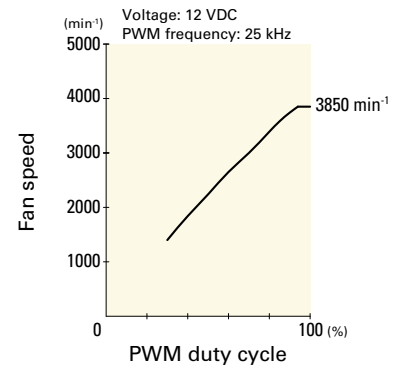

9WL0912P4H001 With pulse sensor with PWM control function

PWM duty cycle

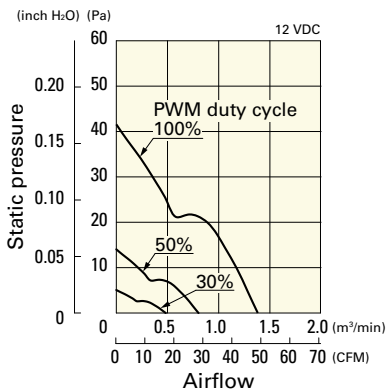

Operating voltage range

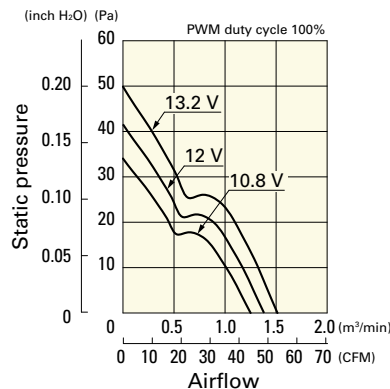

PWM duty - Speed characteristics example

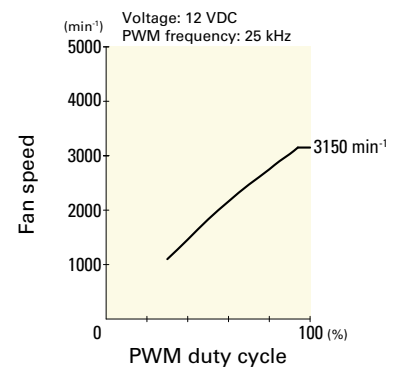

Airflow - Static Pressure Characteristics / PWM Duty - Speed Characteristics Example

9WL0924P4J001 With pulse sensor with PWM control function

PWM duty cycle

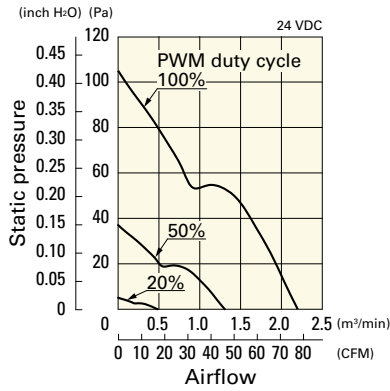

Operating voltage range

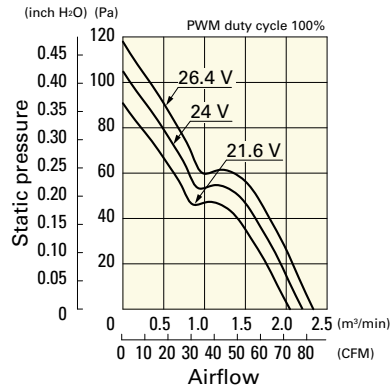

PWM duty - Speed characteristics example

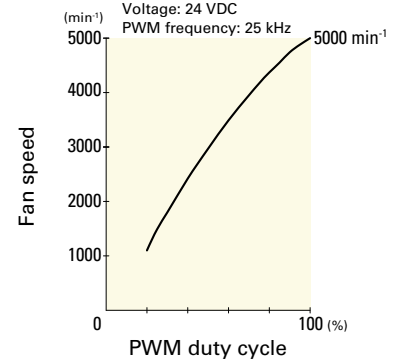

9WL0924P4S001 With pulse sensor with PWM control function

PWM duty cycle

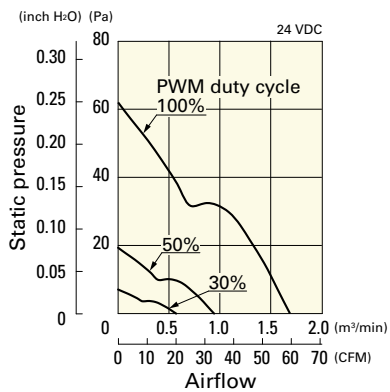

Operating voltage range

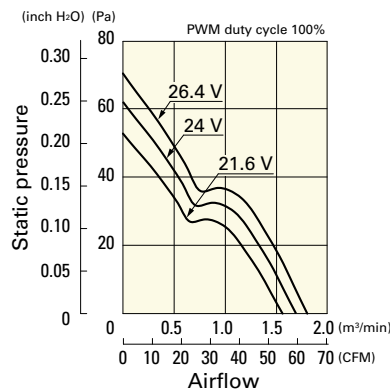

PWM duty - Speed characteristics example

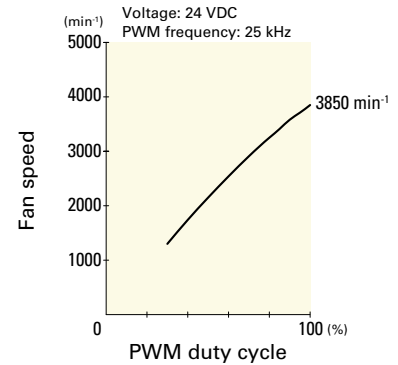

9WL0924P4H001 With pulse sensor with PWM control function

PWM duty cycle

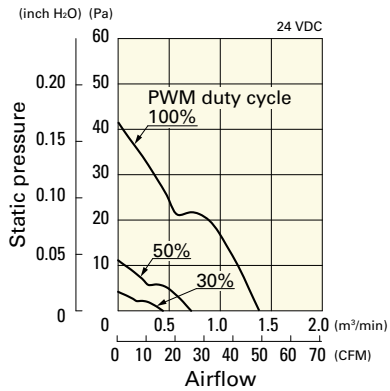

Operating voltage range

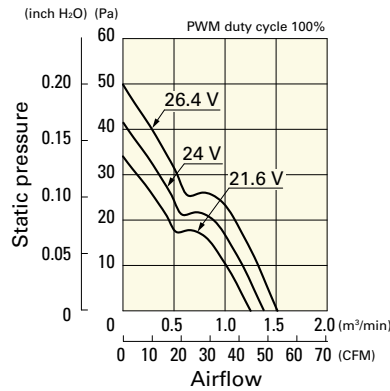

PWM duty - Speed characteristics example

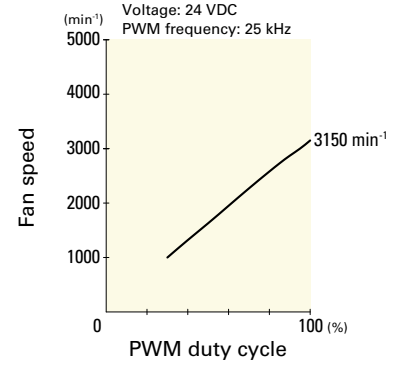

DC
Splash Proof Fan 92 mm sq.

Airflow - Static Pressure Characteristics

9WL0912M4001 With pulse sensor

Operating voltage range

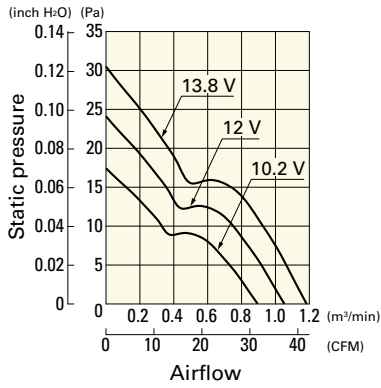

9WL0924F4001 With pulse sensor

Operating voltage range

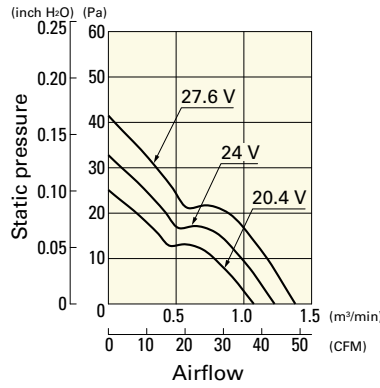

9WL0924M4001 With pulse sensor

Operating voltage range

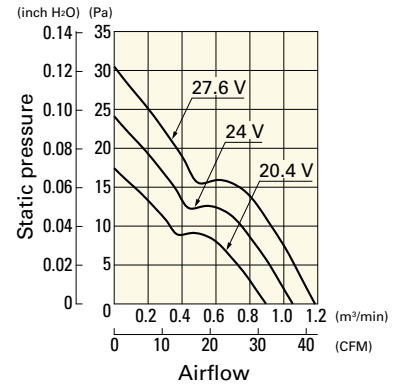

Dimensions (unit: mm) (With pulse sensor with PWM control function)

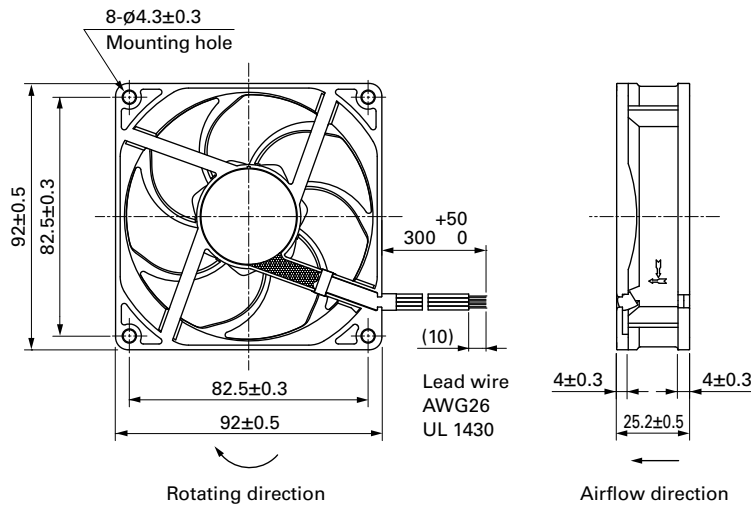

Reference Dimensions of Mounting Holes and Vent Opening (unit: mm)

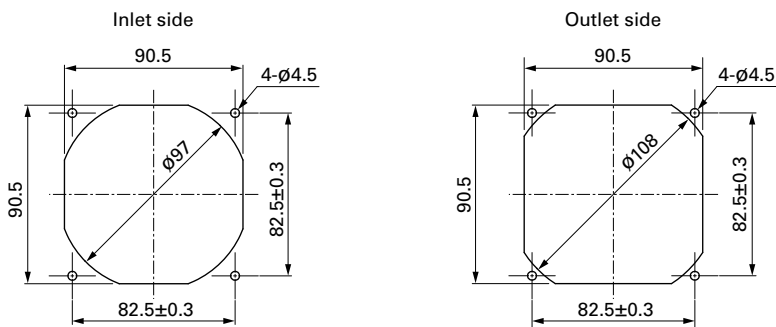

Options

Finger guards

page: p. 584

Model no.: 109-099E, 109-099H, 109-099C

Resin finger guards

page: p. 591

Model no.: 109-101G