

产品规格书 Product Specification



Data Sheet – GLA Series

Model No.: GLA-3510
GLA-3520

Features & Typical Applications:

- High Efficiency
- Available with 2 beam angles
- Optimized Uniformity
- With holder
- Commercial Lighting
- Optical PMMA material
- Vacuum aluminum plating+ UV coating
- Dia35mm* H9mm

产品规格书 Product Specification

Mechanical Specification : GLA-3510 / GLA-3520

- 1) All dimensions are in mm
- 2) All tolerance are $\pm 0.2\text{mm}$ unless otherwise specified

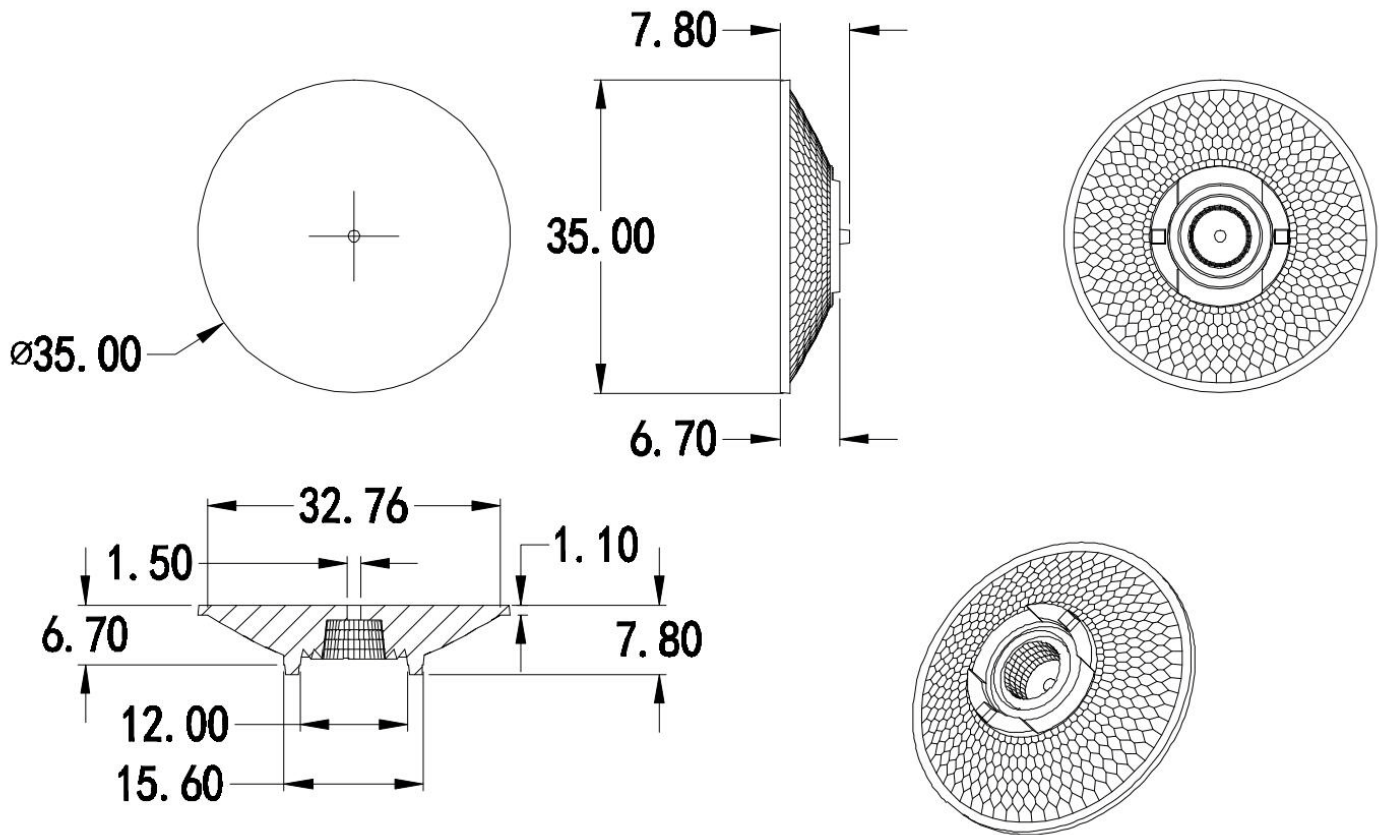

产品规格书 Product Specification

Optical Specification :



CXA1304 : LES 7.5mm

**GLA-3510
FWHM 14°**

Luminous Intensity Distribution Curve(cd/klm)

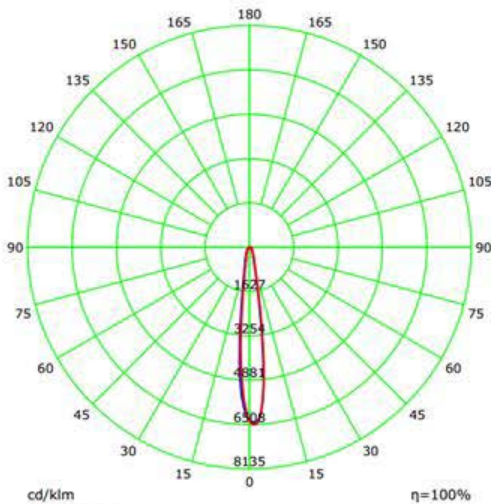

cd/klm
— C0-C180
— C90-C270

$\eta=100\%$

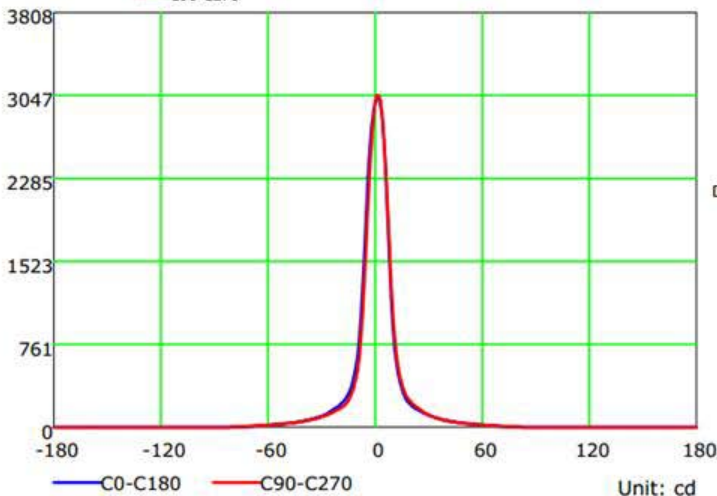

Unit: cd

Illuminance at a Distance

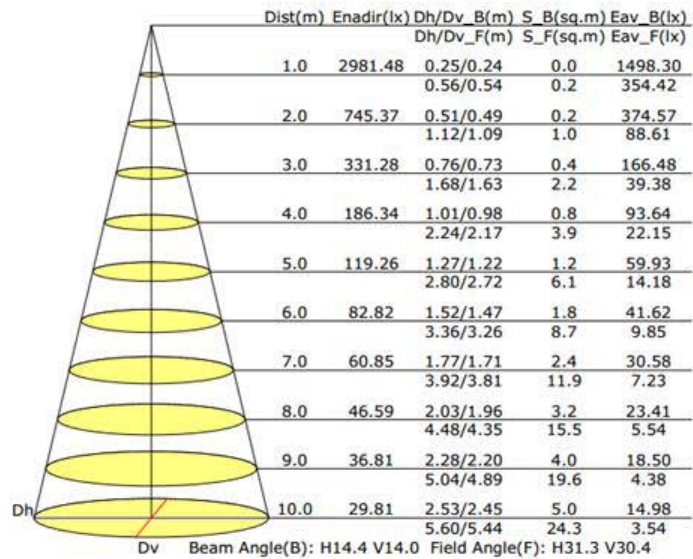

产品规格书 Product Specification

Optical Specification :



CXA1304 : LES 7.5mm

GLA-3520

FWHM 20.8°

Luminous Intensity Distribution Curve(cd/klm)

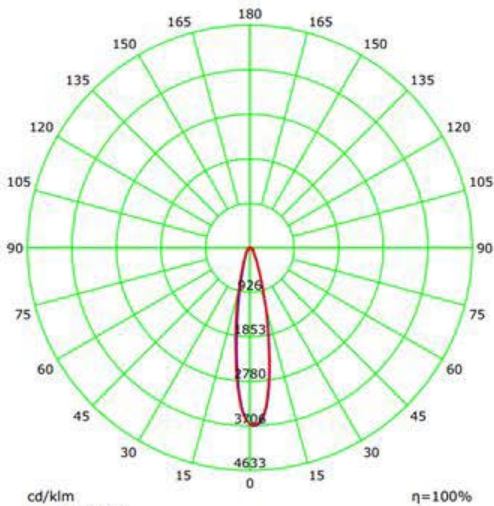

Illuminance at a Distance

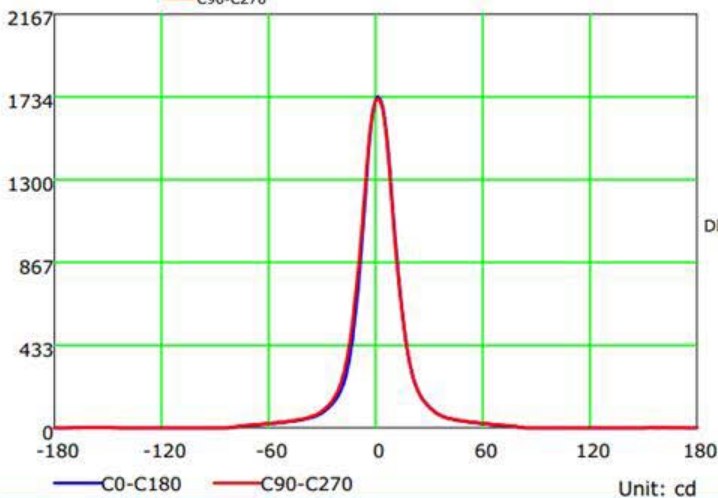
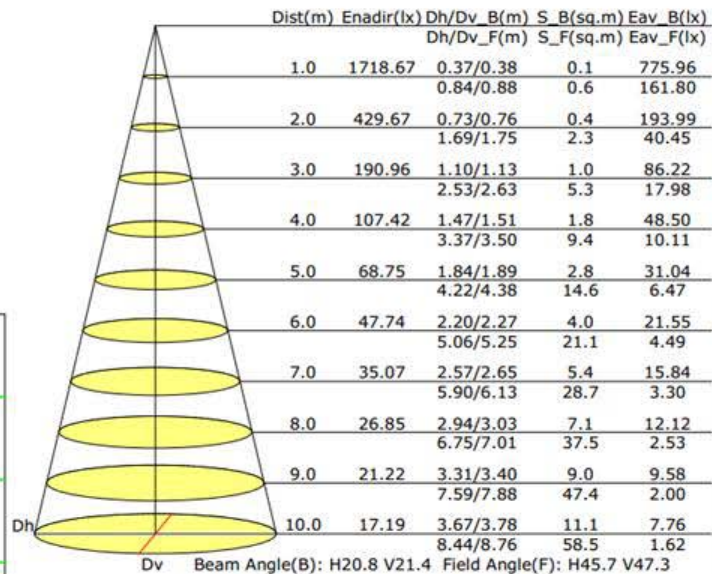

产品规格书 Product Specification

Package Specifications

Item	Quantity	Total	Size	G.W
Small box	576pcs	576pcs	32*24.5*12.3 cm	2.91
Outer box	6 small/outer box	3456pcs	51x34x41cm	18.31

Packing Details

