



80x80x25 mm

San Ace 80 9GA type Low Power Consumption Fan

General Specifications

- Material Frame: Plastic (Flammability: UL 94V-0), Impeller: Plastic (Flammability: UL 94V-0)
- Expected life See the table below. (L10 life: 90% survival rate for continuous operation in free air at 60°C, rated voltage)
Expected life at 40°C is for reference only.
- Motor protection function Locked rotor burnout protection, Reverse polarity protection
For details, please refer to p. 599.
- Dielectric strength 50/60 Hz, 500 VAC, for 1 minute (between lead wire conductors and frame)
- Insulation resistance 10 MΩ or more with a 500 VDC megger (between lead wire conductors and frame)
- Sound pressure level (SPL) At 1 m away from the air inlet
- Storage temperature -30 to +70°C (Non-condensing)
- Lead wire ⊕Red ⊖Black (Sensor) Yellow (Control) Brown
- Mass 110 g

Specifications

The models listed below **have ribs and pulse sensors with PWM control function**. For models without ribs, append "1" to the end of model numbers.

Model no.	Rated voltage [V]	Operating voltage range [V]	PWM duty cycle* [%]	Rated current [A]	Rated input [W]	Rated speed [min ⁻¹]	Max. airflow [m ³ /min] [CFM]	Max. static pressure [Pa] [inchH ₂ O]	SPL [dB (A)]	Operating temperature [°C]	Expected life [h]
9GA0812P4J001	12	10.8 to 13.2	100	0.6	7.2	7400	2.07 73.0	177.6 0.7	48	-20 to +70	40000/60°C (70000/40°C)
			25	0.08	0.96	2500	0.69 24.3	20.2 0.08	21		
9GA0812P4G001			100	0.48	5.76	6800	1.91 67.4	150 0.6	45		
			25	0.06	0.72	1500	0.42 14.8	7.2 0.02	17		
9GA0812P4H001			100	0.22	2.64	5200	1.46 51.5	87.7 0.35	37		
			25	0.06	0.72	1600	0.44 15.5	8.3 0.03	17		
9GA0824P4J001	24	21.6 to 26.4	100	0.28	6.72	7400	2.07 73.0	177.6 0.7	48		
			25	0.06	1.44	2800	0.78 27.5	25.4 0.1	23		
9GA0824P4G001			100	0.21	5.04	6800	1.91 67.4	150 0.6	45		
			25	0.04	0.96	2100	0.58 20.4	14.3 0.05	19		
9GA0824P4H001			100	0.1	2.4	5200	1.46 51.5	87.7 0.35	37		
			25	0.02	0.48	1500	0.42 14.8	7.2 0.02	17		

* PWM input frequency is 25 kHz; models without specifications at 0% PWM duty cycle have zero fan speed at 0%.

Note 1: Sensor and control options are available for selection. Refer to the table on pp. 629 to 630.

Note 2: The mark indicates Short LeadTime Service applicable models. See p. 654 for details.

Airflow - Static Pressure Characteristics / PWM Duty - Speed Characteristics Example

9GA0812P4J001 With pulse sensor with PWM control function

PWM duty cycle

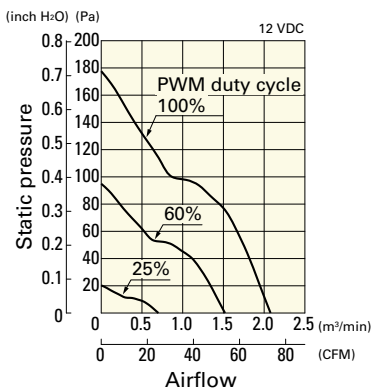

Operating voltage range

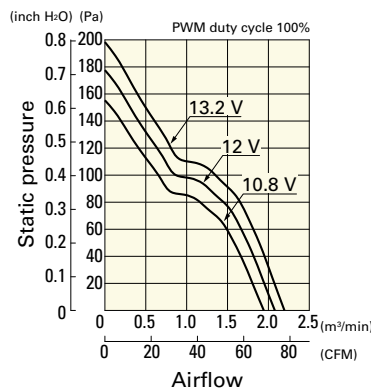

PWM duty - Speed characteristics example

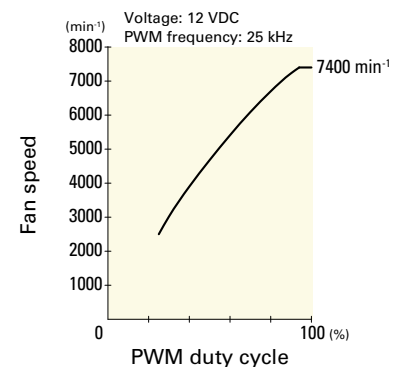

Airflow - Static Pressure Characteristics / PWM Duty - Speed Characteristics Example

9GA0812P4G001 With pulse sensor with PWM control function

PWM duty cycle

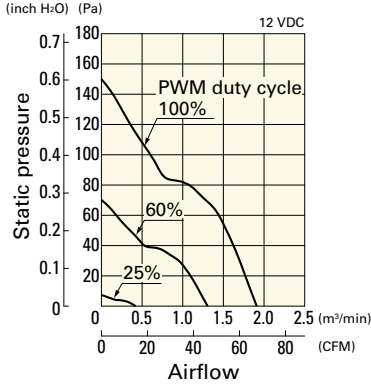

Operating voltage range

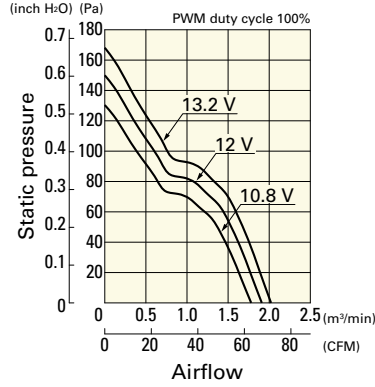

PWM duty - Speed characteristics example

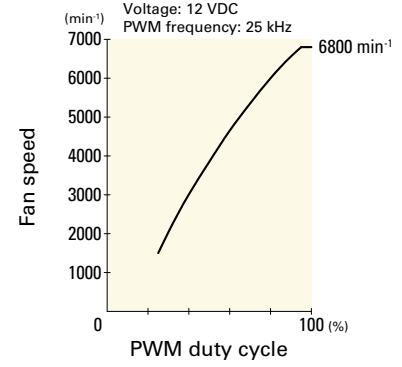

9GA0812P4H001 With pulse sensor with PWM control function

PWM duty cycle

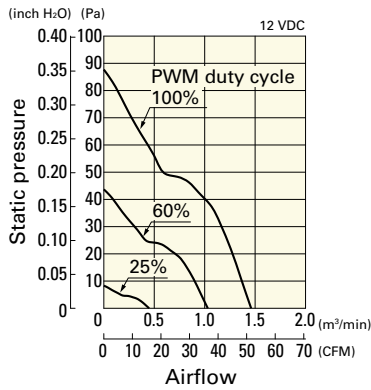

Operating voltage range

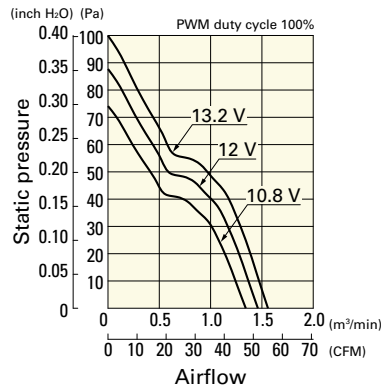

PWM duty - Speed characteristics example

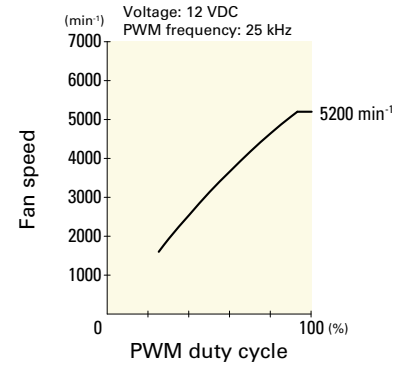

9GA0824P4J001 With pulse sensor with PWM control function

PWM duty cycle

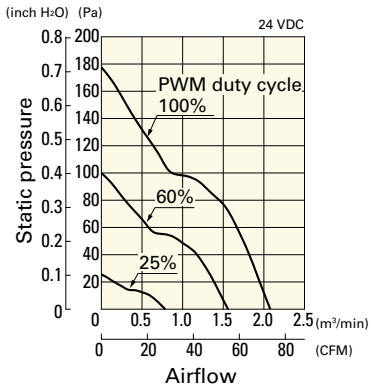

Operating voltage range

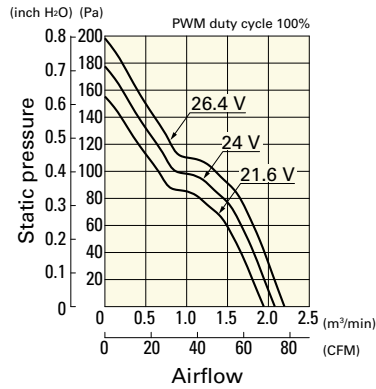

PWM duty - Speed characteristics example

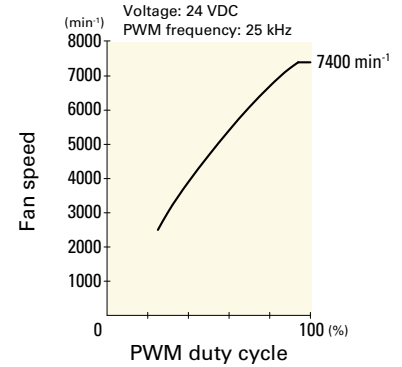

9GA0824P4G001 With pulse sensor with PWM control function

PWM duty cycle

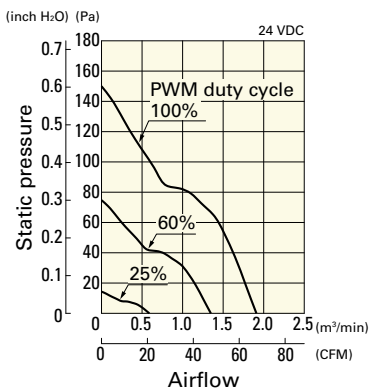

Operating voltage range

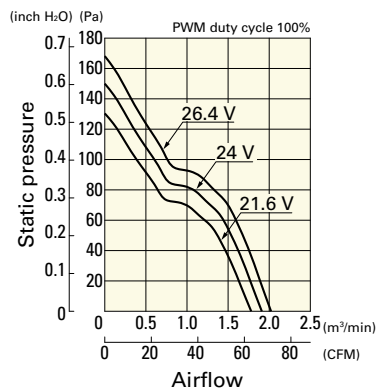

PWM duty - Speed characteristics example

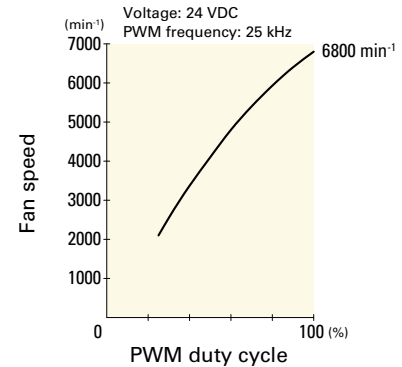

Airflow - Static Pressure Characteristics / PWM Duty - Speed Characteristics Example

9GA0824P4H001 With pulse sensor with PWM control function

PWM duty cycle

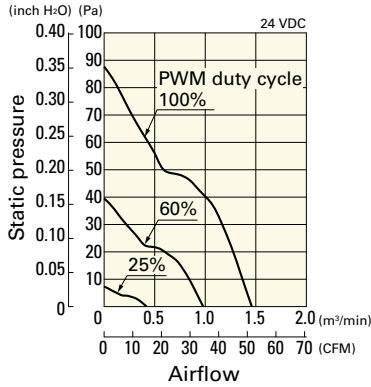

Operating voltage range

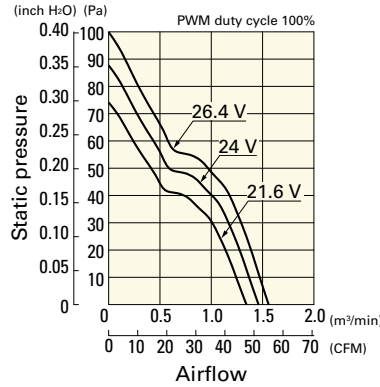

PWM duty - Speed characteristics example

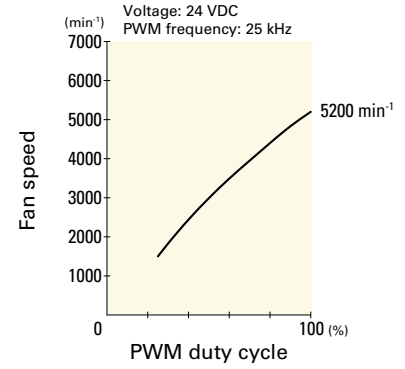

Dimensions (unit: mm) (With ribs)

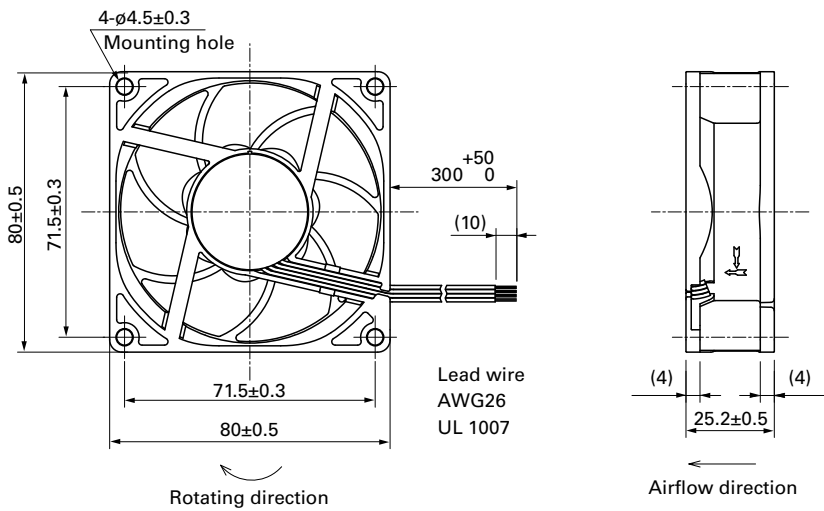

Reference Dimensions of Mounting Holes and Vent Opening (unit: mm)

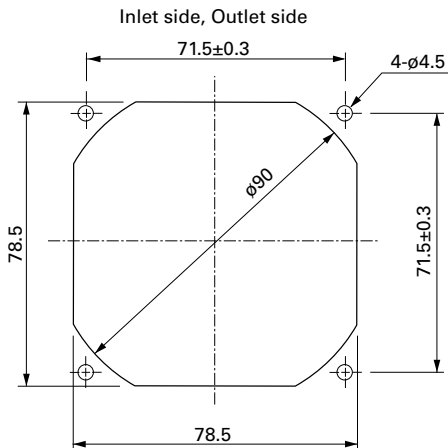

Options

Finger guards page: p. 584

Model no.: 109-049E, 109-049H, 109-049C

Resin finger guards page: p. 591

Model no.: 109-1002G

Resin filter kits page: p. 592

Model no.: 109-1002F13 (13PPI), 109-1002F20 (20PPI),
109-1002F30 (30PPI), 109-1002F40 (40PPI)