



60x60x38 mm

San Ace 60 9GA type Low Power Consumption Fan

General Specifications

- Material Frame: Plastic (Flammability: UL 94V-0), Impeller: Plastic (Flammability: UL 94V-0)
- Expected life See the table below. (L10 life: 90% survival rate for continuous operation in free air at 60°C, rated voltage)
Expected life at 40°C is for reference only.
- Motor protection function Locked rotor burnout protection, Reverse polarity protection
For details, please refer to p. 599.
- Dielectric strength 50/60 Hz, 500 VAC, for 1 minute (between lead wire conductors and frame)
- Insulation resistance 10 MΩ or more with a 500 VDC megger (between lead wire conductors and frame)
- Sound pressure level (SPL) At 1 m away from the air inlet
- Storage temperature -30 to +70°C (Non-condensing)
- Lead wire ⊕Red ⊖Black (Sensor) Yellow (Control) Brown
- Mass 130 g

Specifications

The models listed below **have ribs and pulse sensors with PWM control function**. For models without ribs, append "1" to the end of model numbers.

Model no.	Rated voltage [V]	Operating voltage range [V]	PWM duty cycle* [%]	Rated current [A]	Rated input [W]	Rated speed [min ⁻¹]	Max. airflow [m ³ /min] [CFM]	Max. static pressure [Pa] [inchH ₂ O]	SPL [dB (A)]	Operating temperature [°C]	Expected life [h]		
▶▶ 9GA0612P1J03	12	10.8 to 12.6	100	1.5	18.0	17500	1.75 62	820 3.3	63	-20 to +60	40000/60°C (70000/40°C)		
			20	0.1	1.2	4000	0.4 14	43 0.17	24				
▶▶ 9GA0612P1K03		10.8 to 13.2	100	0.95	11.4	14800	1.5 53	600 2.4	59			-20 to +70	
			20	0.1	1.2	4000	0.4 14	43 0.17	24				
▶▶ 9GA0612P1K60				100	0.95	11.4	14800	1.5 53	675 2.7			59	-20 to +60
▶▶ 9GA0612P1H03				0	0.05	0.6	1480	0.134 4.7	8.3 0.03			16	-20 to +60
				100	0.55	6.6	11500	1.15 40	375 1.5	52		-20 to +70	
				20	0.06	0.72	2600	0.27 9.5	20 0.08	19		-20 to +70	
▶▶ 9GA0624P1J03		24	21.6 to 25.2	100	0.75	18.0	17500	1.75 62	820 3.3	63		-20 to +60	
				20	0.1	2.4	6200	0.63 22	104 0.42	35			
▶▶ 9GA0624P1K03			21.6 to 26.4	100	0.5	12	14800	1.5 53.0	600 2.4	59		-20 to +70	
				20	0.06	1.44	5000	0.5 17.7	70 0.28	28			

* PWM input frequency is 25 kHz; models without specifications at 0% PWM duty cycle have zero fan speed at 0%.

Note 1: Sensor and control options are available for selection. Refer to the table on p. 629.

Note 2: The ▶▶ mark indicates Short LeadTime Service applicable models. See p. 654 for details.

Airflow - Static Pressure Characteristics / PWM Duty - Speed Characteristics Example

9GA0612P1J03 With pulse sensor with PWM control function

PWM duty cycle

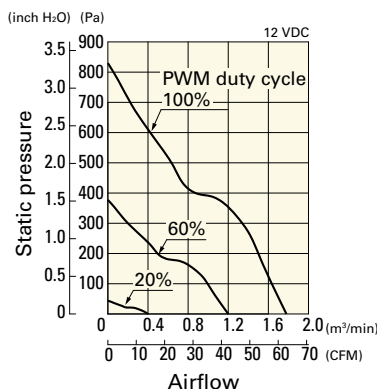

Operating voltage range

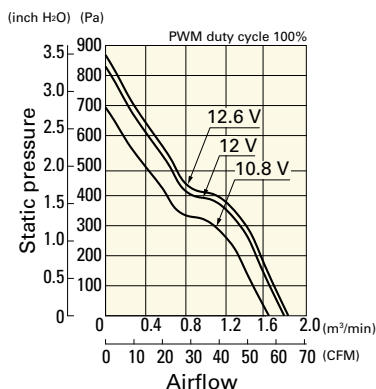

PWM duty - Speed characteristics example

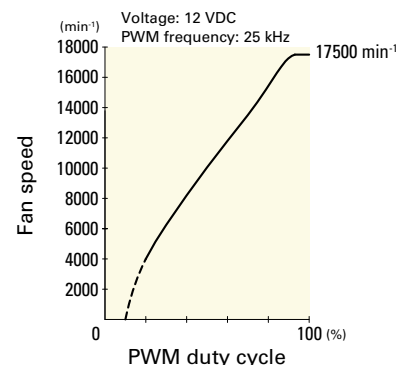

Airflow - Static Pressure Characteristics / PWM Duty - Speed Characteristics Example

9GA0612P1K03 With pulse sensor with PWM control function

PWM duty cycle

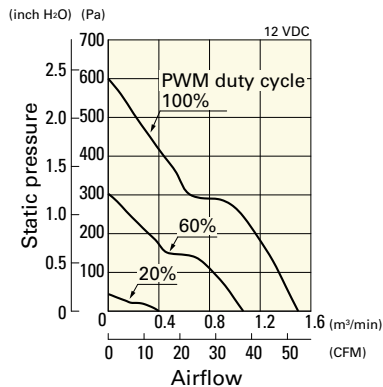

Operating voltage range

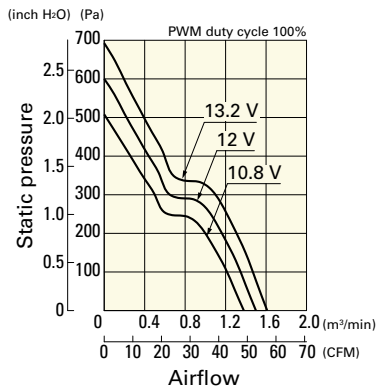

PWM duty - Speed characteristics example

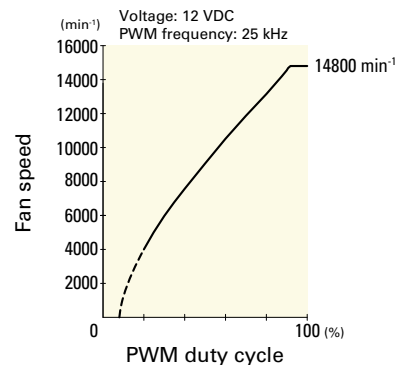

9GA0612P1K60 With pulse sensor with PWM control function

PWM duty cycle

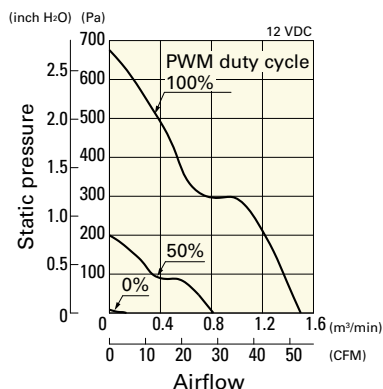

Operating voltage range

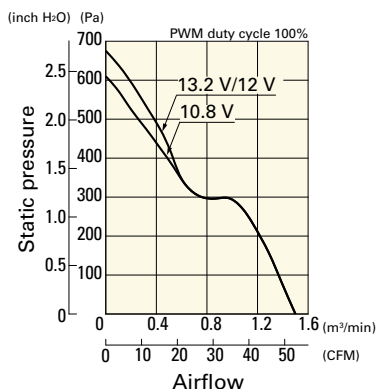

PWM duty - Speed characteristics example

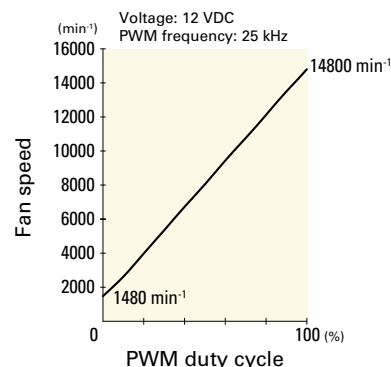

9GA0612P1H03 With pulse sensor with PWM control function

PWM duty cycle

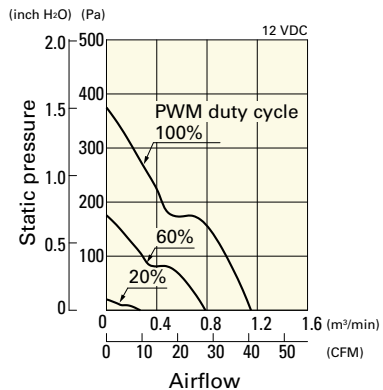

Operating voltage range

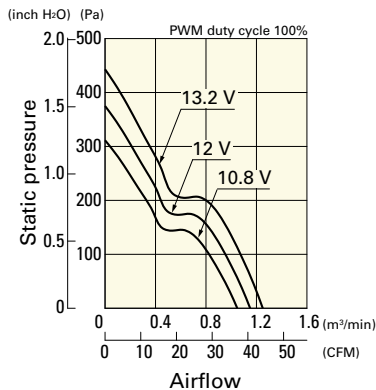

PWM duty - Speed characteristics example

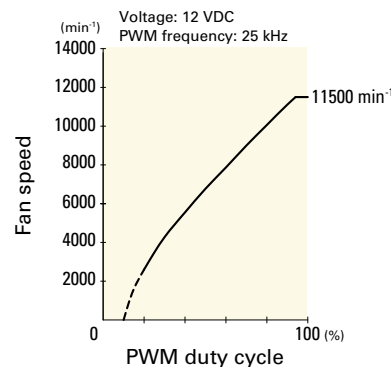

9GA0624P1J03 With pulse sensor with PWM control function

PWM duty cycle

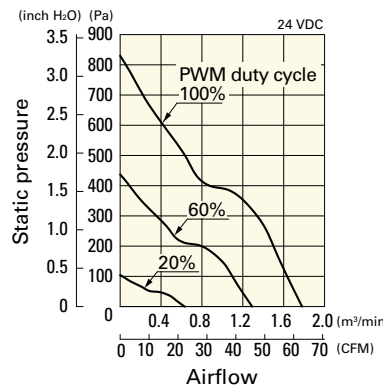

Operating voltage range

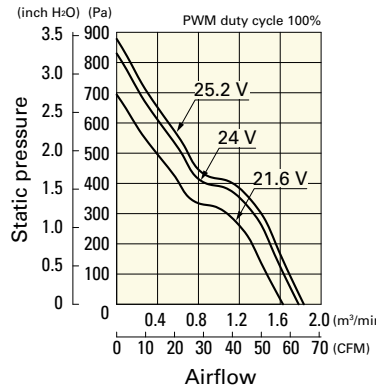

PWM duty - Speed characteristics example

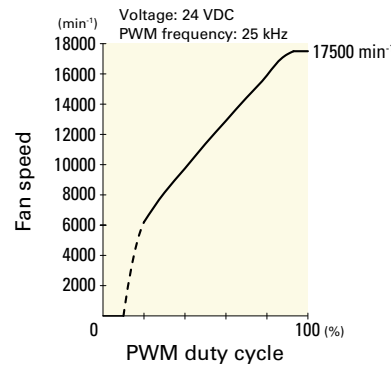

Airflow - Static Pressure Characteristics / PWM Duty - Speed Characteristics Example

9GA0624P1K03 With pulse sensor with PWM control function

PWM duty cycle

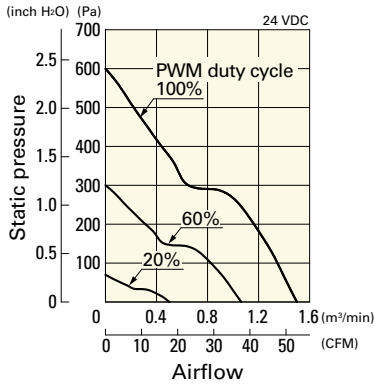

Operating voltage range

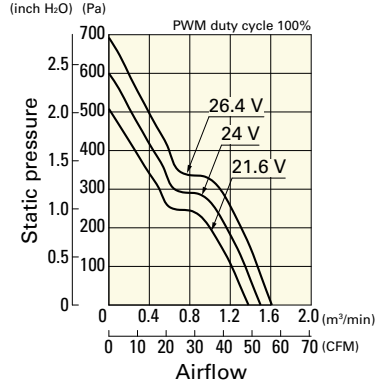

PWM duty - Speed characteristics example

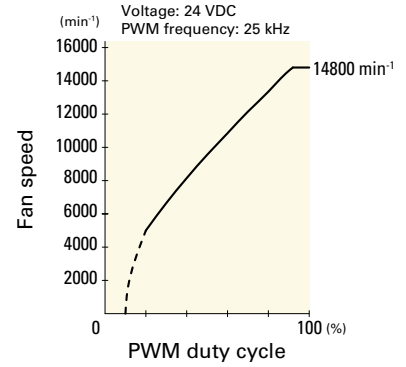

Dimensions (unit: mm) (With ribs)

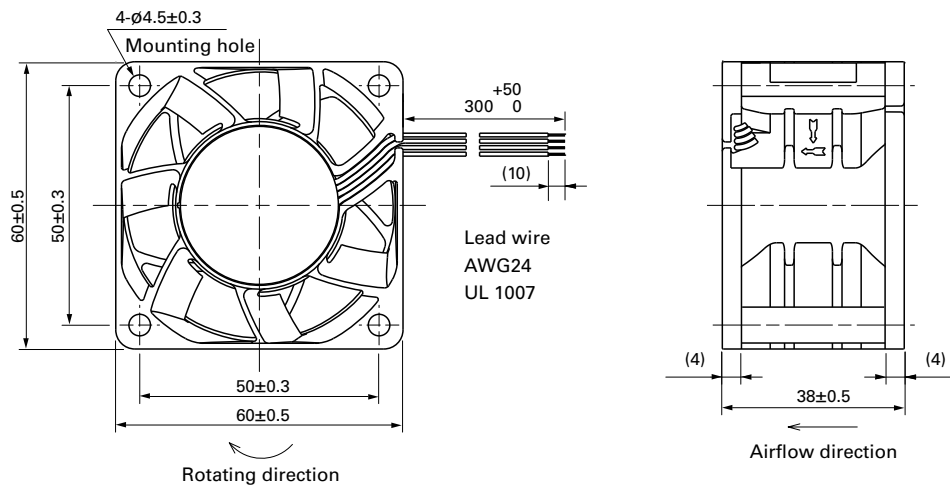

Reference Dimensions of Mounting Holes and Vent Opening (unit: mm)

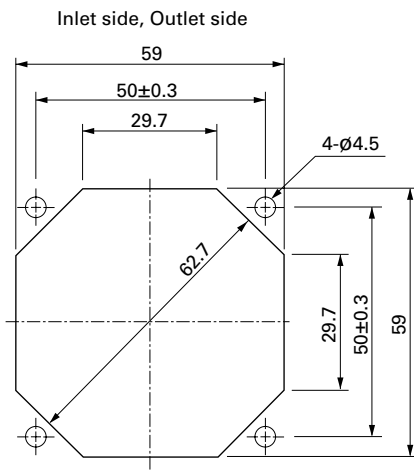

Options

Finger guards

page: p. 584

Model no.: 109-139E, 109-139H

Resin finger guards

page: p. 591

Model no.: 109-1003G

Resin filter kits

page: p. 592

Model no.: 109-1003F13 (13PPI), 109-1003F20 (20PPI),
109-1003F30 (30PPI), 109-1003F40 (40PPI)