

DC Fan

# 60×60×25 mm

San Ace 60 9R type   



## General Specifications

- Material ..... Frame: Plastic (Flammability: UL 94V-0), Impeller: Plastic (Flammability: UL 94V-1)
- Expected life ..... See the table below. (L10 life: 90% survival rate for continuous operation in free air at 60°C, rated voltage)  
Expected life at 40°C is for reference only.
- Motor protection function ..... Locked rotor burnout protection, Reverse polarity protection  
For details, please refer to p. 599.
- Dielectric strength ..... 50/60 Hz, 500 VAC, for 1 minute (between lead wire conductors and frame)
- Insulation resistance ..... 10 MΩ or more with a 500 VDC megger (between lead wire conductors and frame)
- Sound pressure level (SPL) ..... At 1 m away from the air inlet
- Storage temperature ..... -30 to +70°C (Non-condensing)
- Lead wire ..... ⊕Red ⊖Black or Blue  Sensor Yellow
- Mass ..... 90 g

## Specifications

The models listed below **have ribs and pulse sensors**. For models without ribs, append "1" to the end of model numbers.

Model no.	Rated voltage [V]	Operating voltage range [V]	Rated current [A]	Rated input [W]	Rated speed [min <sup>-1</sup> ]	Max. airflow [m <sup>3</sup> /min] [CFM]		Max. static pressure [Pa] [inchH <sub>2</sub> O]		SPL [dB (A)]	Operating temperature [°C]	Expected life [h]	
» 109R0605H401	5	4.5 to 5.5	0.34	1.7	3800	0.53	18.7	40.2	0.161	28	-20 to +70	60000/60°C (90000/40°C)	
» 109R0605F401			0.2	1.0	3200	0.44	15.5	29.4	0.118	24	-20 to +60		
» 109R0605M401			0.13	0.65	2600	0.36	12.7	19.6	0.079	20	-20 to +70		
» 109R0612J401	12	10.8 to 13.2	0.47	5.64	7600	1.06	37.1	155.0	0.622	44	-20 to +60	40000/60°C (70000/40°C)	
» 109R0612G401			0.24	2.88	5600	0.78	27.5	87.3	0.351	39	-20 to +70		
» 109R0612D401		10.2 to 13.8	0.21	2.52	5150	0.72	25.4	73.5	0.295	37			
» 109R0612S401		6 to 13.8	0.17	2.04	4600	0.65	23.0	56.8	0.228	33			
» 109R0612H401			0.11	1.32	3800	0.53	18.7	40.1	0.161	28			
» 109R0612F401			0.09	1.08	3200	0.44	15.5	29.4	0.118	24			
» 109R0612M401		7 to 13.8	0.06	0.72	2600	0.36	12.7	19.6	0.079	20			
» 109R0624J401		24	21.6 to 26.4	0.24	5.76	7600	1.06	37.1	155.0	0.622		44	-20 to +60
» 109R0624G401			20.4 to 27.6	0.13	3.12	5600	0.78	27.5	87.3	0.351	39	-20 to +70	
» 109R0624D401	12 to 27.6		0.12	2.88	5150	0.72	25.4	73.5	0.295	37			
» 109R0624S401			0.08	1.92	4600	0.65	23.0	56.8	0.228	33			
» 109R0624H401			0.06	1.44	3800	0.53	18.7	40.2	0.161	28			
» 109R0624F401	0.05		1.2	3200	0.44	15.5	29.4	0.118	24				
» 109R0624M401	14 to 27.6		0.04	0.96	2600	0.36	12.7	19.6	0.079	20			
» 109R0648J401	48	43.2 to 52.8	0.12	5.76	7600	1.06	37.1	155.0	0.622	44	-20 to +60	40000/60°C (70000/40°C)	
» 109R0648G401		43 to 53	0.07	3.36	5600	0.78	27.5	87.3	0.351	39			
» 109R0648H401		40 to 53	0.04	1.92	3800	0.53	18.7	40.2	0.161	28	-20 to +70	60000/60°C (90000/40°C)	

Note 1: Sensor and control options are available for selection. Refer to the table on pp. 622 to 623.

Note 2: The » mark indicates Short LeadTime Service applicable models. See p. 654 for details.

# Airflow - Static Pressure Characteristics

**109R0605H401** With pulse sensor

Operating voltage range

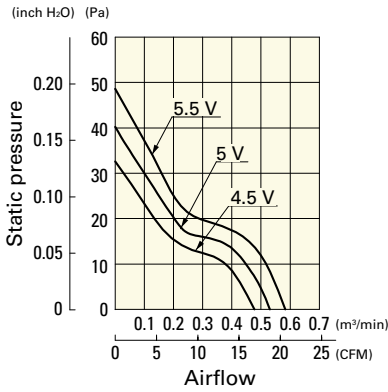

**109R0605F401** With pulse sensor

Operating voltage range

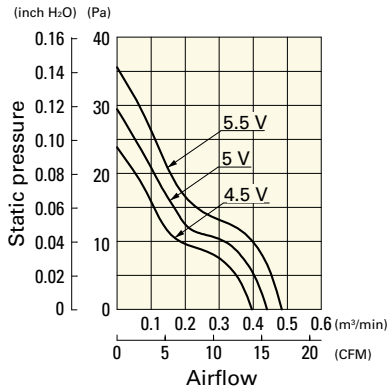

**109R0605M401** With pulse sensor

Operating voltage range

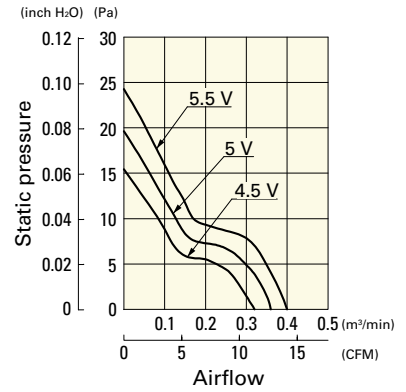

**109R0612J401** With pulse sensor

Operating voltage range

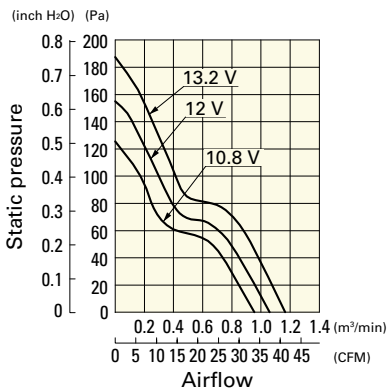

**109R0612G401** With pulse sensor

Operating voltage range

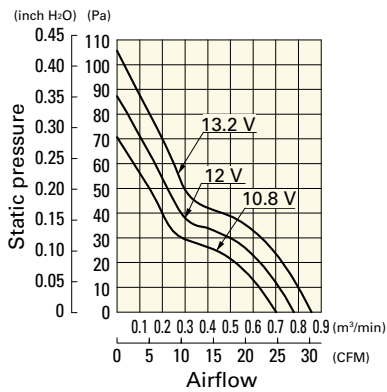

**109R0612D401** With pulse sensor

Operating voltage range

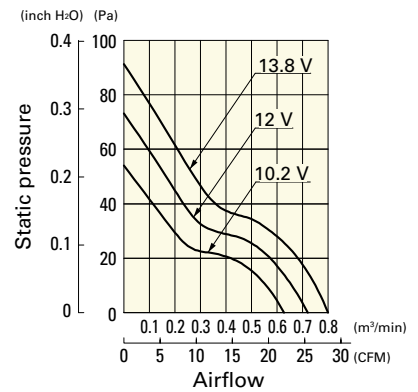

**109R0612S401** With pulse sensor

Operating voltage range

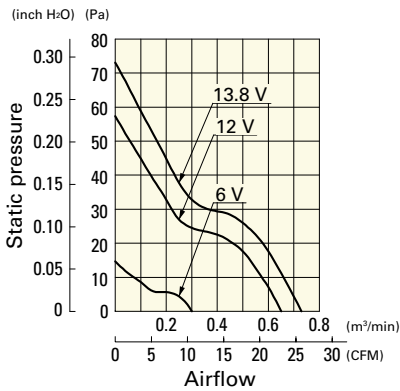

**109R0612H401** With pulse sensor

Operating voltage range

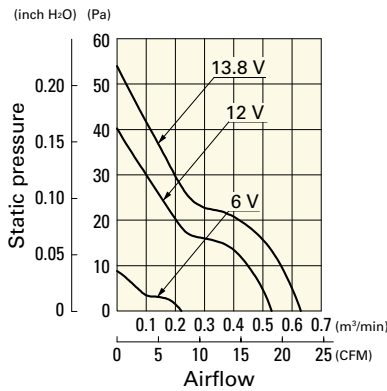

**109R0612F401** With pulse sensor

Operating voltage range

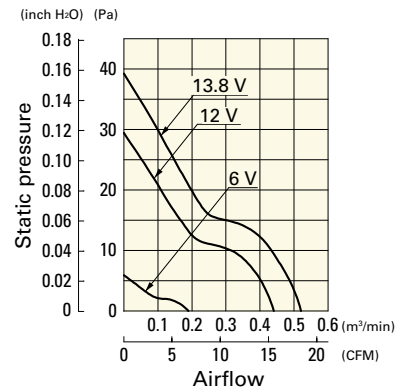

**109R0612M401** With pulse sensor

Operating voltage range

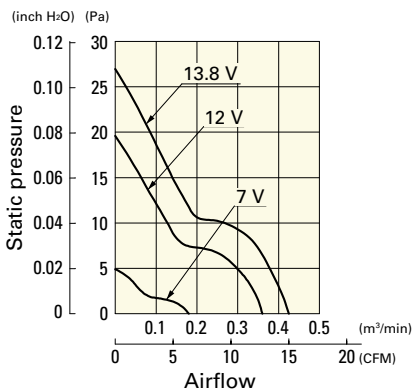

**109R0624J401** With pulse sensor

Operating voltage range

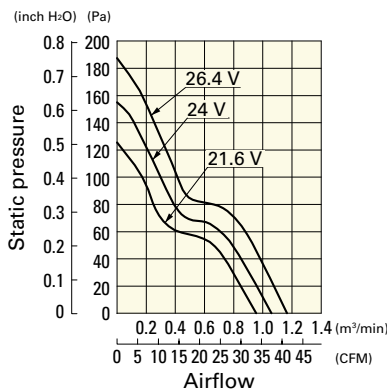

**109R0624G401** With pulse sensor

Operating voltage range

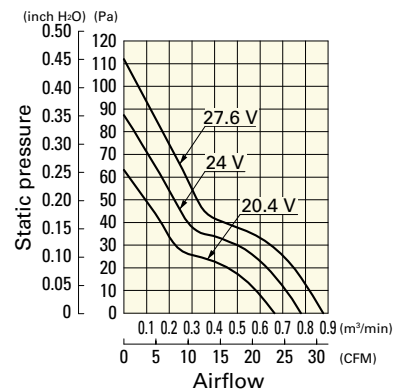

**Airflow - Static Pressure Characteristics**

**109R0624D401** With pulse sensor

Operating voltage range

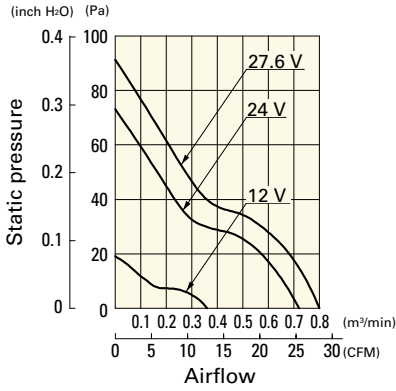

**109R0624S401** With pulse sensor

Operating voltage range

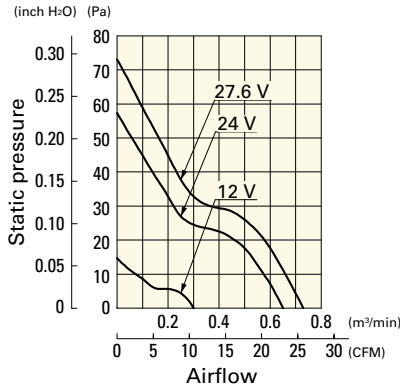

**109R0624H401** With pulse sensor

Operating voltage range

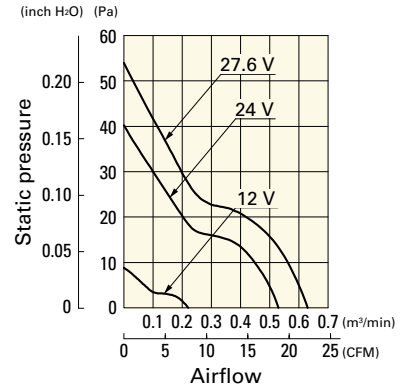

**109R0624F401** With pulse sensor

Operating voltage range

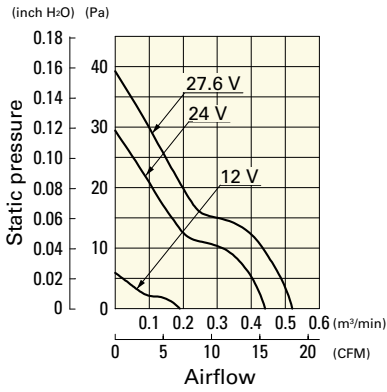

**109R0624M401** With pulse sensor

Operating voltage range

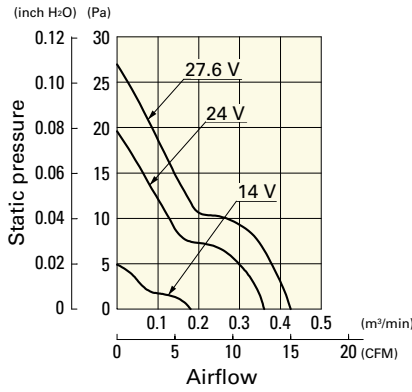

**109R0648J401** With pulse sensor

Operating voltage range

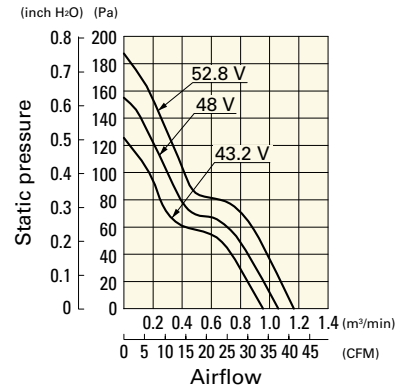

**109R0648G401** With pulse sensor

Operating voltage range

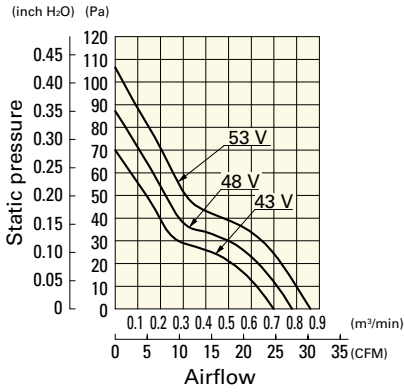

**109R0648H401** With pulse sensor

Operating voltage range

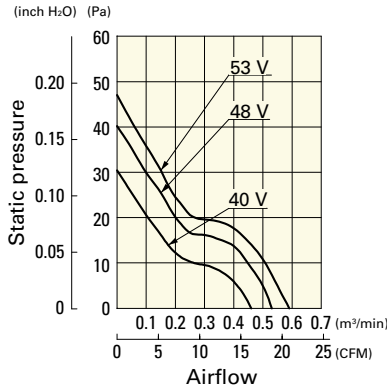

**Dimensions (unit: mm) (With ribs)**

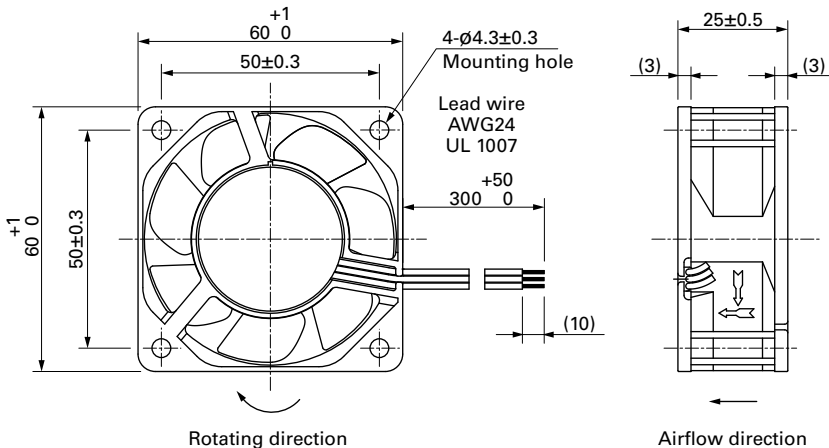

■ **Reference Dimensions of Mounting Holes and Vent Opening** (unit: mm)

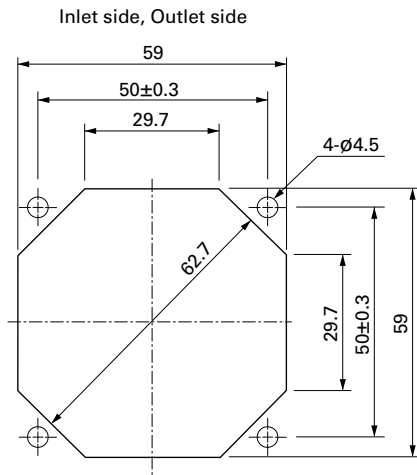

■ **Options**

**Finger guards**

page: p. 584

Model no.: 109-139E, 109-139H

**Resin finger guards**

page: p. 591

Model no.: 109-1003G

**Resin filter kits**

page: p. 592

Model no.: 109-1003F13 (13PPI), 109-1003F20 (20PPI),  
109-1003F30 (30PPI), 109-1003F40 (40PPI)