

Product Features



- Universal input voltage / Full range: 90~305Vac;
- Constant power design, output current programmable;
- (M types) off-line programmable, (V types) output current adjustable by built-in potentiometer;
- 3-in-1 dimmable: 0~10V/PWM/ Timer dimming. m-to-off;
- Constant lumen output
- Output and dimming signal isolating
- Surge protection: 5KV line-line, 10KV line-earth;
- Protections: SCP / OVP / OTP;
- IP67 design for indoor and outdoor applications;
- Suitable for dry / damp / wet locations;
- 5 years warranty.

Application

- Suitable for LED roadway lighting, plant lighting, industrial lighting, landscape lighting, etc.

DESCRIPTION

X6 LED drivers are developed for professional exterior lightings, with premium quality and advanced functionalities.

The X6-105W is a 105W offline programmable LED driver for outdoor LED lightings, which operates in constant current mode, with high efficiency, PF value, and 90~305Vac universal input voltage. Monitored by dimming cable with a USB programming device, the fully programmed driver offers all dimming, smart control, constant lumen output functionalities, and a wide range of output currents in one single driver. The unique design delivers maximum flexibilities with customized operating settings and intelligent control options for lighting manufacturers, as one driver can be used for many different luminaire designs. X6 provides built-in timer dimming schedules, to further increase the energy savings and CO2 reductions achieved with LED lighting. It also helps clients to improve the management of logistics and stock. The compact metal case and high efficiency enable the driver to operate with high reliability, and extending product lifetime. Overall protection is provided against the lightning surge, output overvoltage, short circuit, and over temperature, to ensure an extremely low failure rate.

MODELS

Model Number [1]	Max Output Power (W)	Output Voltage Range (Vdc)	Full Power Voltage Adjustable Range (V)	Full Power Current Adjustable Range (A) [2]	Default Output Current Setting(A)	Typical Efficiency [3]	Power Factor
							230Vac
X6-105X041	105	20-41	30-41	2.56-3.50	2.80	90%	0.97
X6-105X062	105	38-62	42-62	1.69-2.50	2.10	91%	0.97
X6-105X100	105	50-100	75-100	1.05-1.40	1.40	92%	0.97
X6-105X150	105	75-150	100-150	0.70-1.05	1.05	92%	0.97

Notes:

[1]. X can be M or V, X=M means dimmable and offline programmable. The adjustable lout range: 10%-100% I_{max}, X=V means non-dimmable and output current adjusted by built-in potentiometer.

[2]. Output current adjustable range with constant power at max output power;

[3]. All specifications are measured at 25°C ambient temperature, input voltage 230Vac, and the typical value tested by full load, if no specific note.

OPERATING AREA I-V

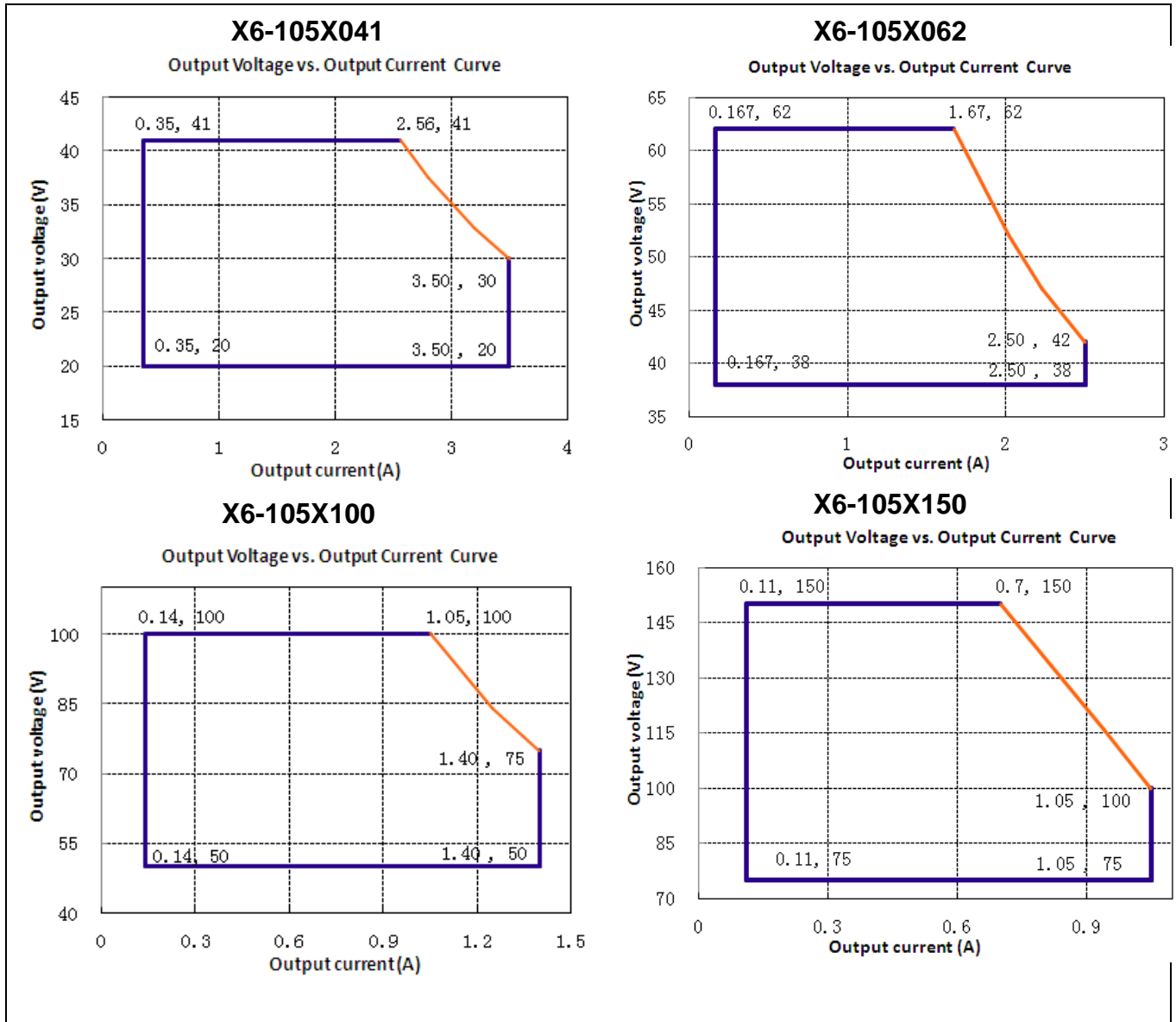

Notes: X=V is suitable for the right area of the dotted line; X=M is suitable for the solid line contain area.

INPUT SPECIFICATIONS

Parameter	Min.	Typ.	Max.	Notes
Input Voltage	90Vac	100-277Vac	305Vac	
Input Frequency	47Hz	50/60	63Hz	
Leakage Current	-	-	0.70mA	277Vac/60Hz
Input AC Current	-	-	2.8A	100-277Vac & full load

Inrush Current	-	-	75A	230Vac & full load
Standby Power Consumption			2W	
Power Factor	0.97	0.99	-	115Vac, 50-60Hz, full load
	0.95	0.97		230Vac, 50-60Hz, full load
	0.9	0.92		277Vac, 50-60Hz, full load
THD	-	5%	10%	100-240Vac, 50-60Hz, 70%-100% load
	-	-	20%	277Vac, 50-60Hz, 70%-100% load

OUTPUT SPECIFICATIONS

Parameter	Min.	Typ.	Max.	Notes
Output Current Tolerance	-5%Iset	-	5%Iset	
Output Current Setting Range (A)				The 'M type' adjustable lout range: 10%-100% I _{max} ,
X6-105X041	1.75		3.50	
X6-105X062	1.25	-	2.50	
X6-105X100	0.70		1.40	
X6-105X150	0.50		1.05	
Output Current Setting Range with Constant Power				
X6-105X041	2.56	-	3.50	
X6-105X062	1.69		2.50	
X6-105X100	1.05		1.40	
X6-105X150	0.70		1.05	
Total Output Current Ripple(pk-pk)	-	5%	10%	20MHz BW, full load & LED load, the ripple would be tiny different under different LED load.
Startup Overshoot Current	-	-	10%	100~277Vac & 100% Load, load is LED
No Load Output Voltage				
X6-105X041			50	
X6-105X062	-	-	70	
X6-105X100			120	
X6-105X150			170	
Line Regulation	-1%	-	1%	25°C±10°C ambient temperature, input voltage changes from 100Vac to 277Vac.
Load Regulation	-3%	-	3%	25°C±10°C ambient temperature, Input Voltage 230Vac, load changes from 60% to 100%.
Turn-on Delay Time	-	1S	2S	115Vac, 100% load
	-	0.5S	1S	230Vac, 100% load

GENERAL SPECIFICATIONS

Parameter	Min.	Typ.	Max.	Notes
Efficiency @115Vac X6-105X041				Measured at full load and 25°C ambient temperature

I _o =2.56 I _o =3.50 X6-105X062 I _o =1.69 I _o =2.50 X6-105X100 I _o =1.05 I _o =1.40	87% 87% 88% 88% 88% 88% 89% 89%	89% 89% 90% 90% 90% 90% 90% 90%			
Efficiency @230Vac X6-105X041 I _o =2.56 I _o =3.50 X6-105X062 I _o =1.69 I _o =2.50 X6-105X100 I _o =1.05 I _o =1.40 X6-105X150 I _o =0.70 I _o =1.05	88% 88% 89% 89% 90% 90% 90% 90%	90% 90% 91% 91% 92% 92% 92% 92%	-	Measured at full load and 25°C ambient temperature	
Efficiency @277Vac X6-105X041 I _o =2.56 I _o =3.50 X6-105X062 I _o =1.69 I _o =2.50 X6-105X100 I _o =1.05 I _o =1.40 X6-105X150 I _o =0.70 I _o =1.05	88% 88% 89% 89% 90% 90% 90% 90%	90% 90% 91% 91% 92% 92% 92% 92%		Measured at full load and 25°C ambient temperature	
Dielectric Strength	Input-Output	-	3750Vac	-	Max 5mA/60S
	Input-PE	-	1600Vac	-	
	Output-PE	-	1600Vac	-	
Grounding Resistance	-	-	0.1Ω	25A/60S, under 25°C±10°C ambient temperature	
Insulation Resistance	50MΩ	-	-	Input-Output, Input-PE, Output-PE, 500Vdc/60S/25°C/70%RH	
MTBF	-	200000Hrs	-	25°C±10°C ambient temperature, 230Vac, 80% load (MIL-HDBK-217F)	
Lifetime	-	50000Hrs	-	230Vac&100% load, 75°C case temperature, refer to lifetime curve for	

				details
Ambient Temperature	-40℃		+60℃	230Vac&100% load
Operating Case Temperature for Safety Tc_s	-40℃	-	+90℃	
Operating Case Temperature for Warranty Tc_s	-40℃	-	+75℃	5 years warranty case temperature Humidity: 10% to 95% RH
Storage Temperature	-40℃	-	+85℃	Humidity: 5% to 100% RH
Dimensions (LxWxH)mm	L153.6*W68*H37			
Net Weight	700±100g/PCS			
Package	L500mm*W310mm*H160mm; 10PCS/Ctn, Gross Weight: 8Kg			

DIMMING

Parameter		Min.	Typ.	Max.	Notes
0~10V Absolute Maximum Voltage on the Vdim (+) Pin		-	10V	-	
0~10V Source Current on Vdim(+)Pin		-	0.1mA	0.2mA	
Dimming Output Range	X6-105M041 X6-105M062 X6-105M100 X6-105M150	10%Imax	-	100%Imax	Imax=3.50A Imax=2.50A Imax=1.40A Imax=1.05A
	X6-105M041 X6-105M062 X6-105M100 X6-105M150	0.35 0.25 0.14 0.10	-	3.50 2.50 1.40 1.05	
Recommended Dimming Range for 0-10V		0V	-	10V	Default 0-10V/ PWM Dimming(0-10V,0-9V,0-5V,0-3.3V can be customized as request)
PWM_in High Level		9.7V	-	10.3V	
PWM_in Low Level		0V	-	0.3V	
PWM_in Frequency Range		200Hz	-	2000Hz	
PWM_in Duty Cycle		1%	-	99%	

SAFTY STANDARDS

Safety Category	Country / Territory	Standards	Approved
CCC	China	GB19510.1, GB19510.14	√
CE	Europe	EN61347-1, EN61347-2-13	√
		EN62493	√
ENEC		EN62384	√
CB	CB Countries	IEC61347-1, IEC61347-2-13	√
BIS	India	IS 15885(PART 2/SEC 13)	
UL	USA	UL 8750	√
CUL	Canada	CSA C22.2 No.250.13	√
KC	South Korea	K61347-1, K61347-2-13	
PSE	Japan	J61347-1, J61347-2-13	
SAA	Australia	AS/NZS IEC 61347.2.13	√
		AS/NZS 61347.1	√

EMC COMPLIANCE

EMC Category	Country / Territory	Standards	Approved
CCC	China	GB/T 17743, GB 17625.1	√
CE	Europe	EN 55015	√
		EN 61000-3-2, EN 61000-3-3	√
		EN61000-4-2,3,4,5,6,11	√
		EN 61547	√
KC	South Korea	K61547	
		K00015	
PSE	Japan	J55015	
FCC	USA	FCC part 15	

NOTE:

This LED driver meets the EMI specifications above, but as a component of a luminaire, end customer need to identify the EMI performance of a luminaire including LED driver, other devices connected to the driver and on the luminaire itself.

INRUSH CURRENT WAVEFORM

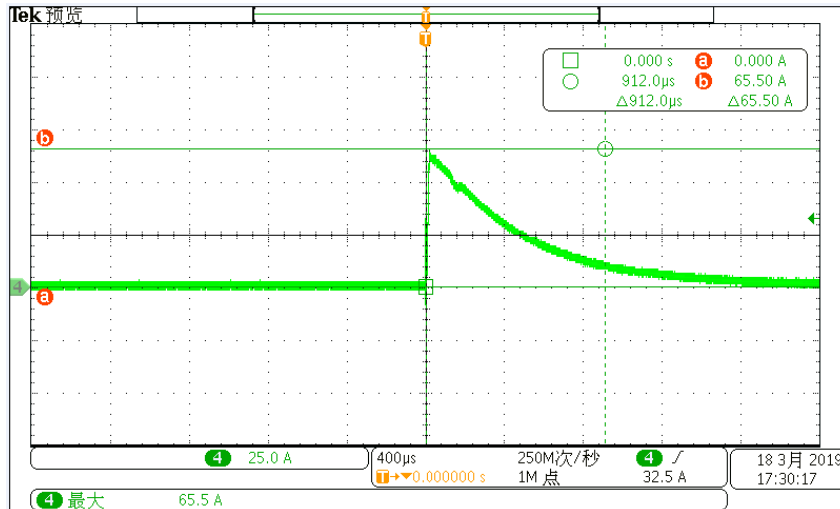

DERATING CURVE

Derating Curve

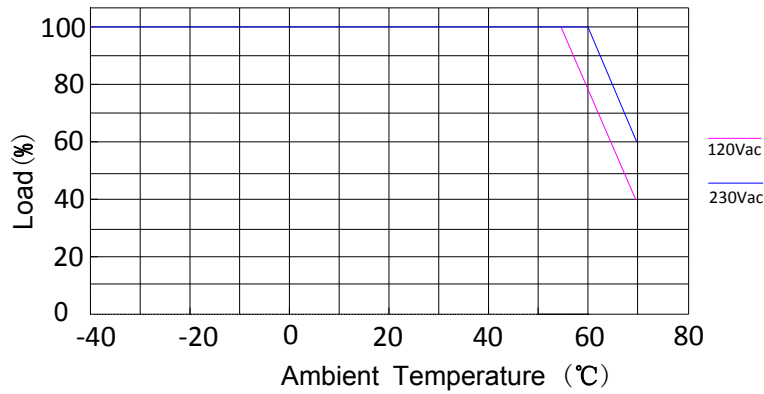

OUTPUT POWER VS INPUT VOLTAGE

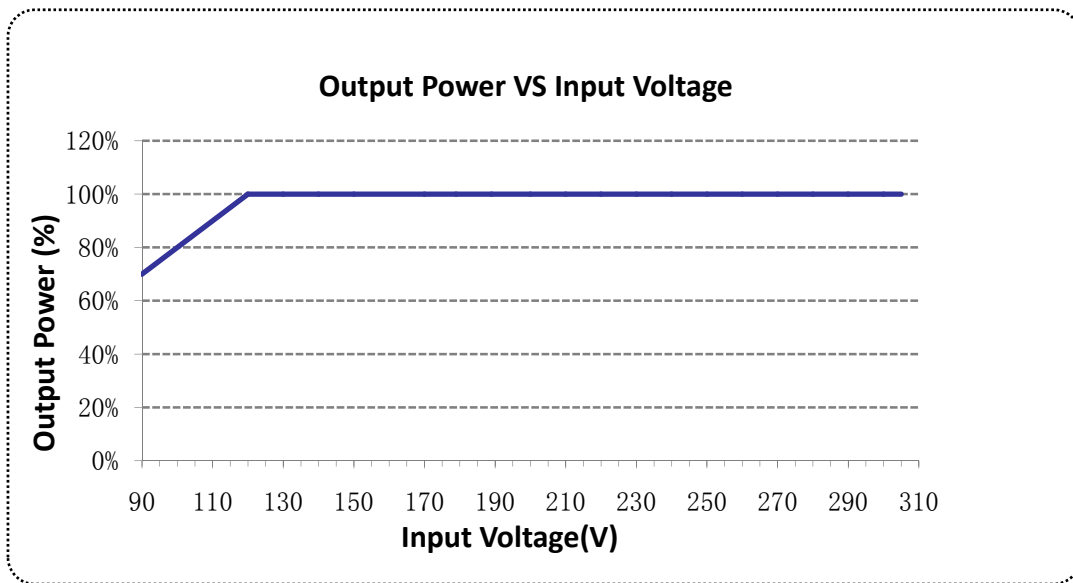

LIFETIME VS CASE TEMPERATURE

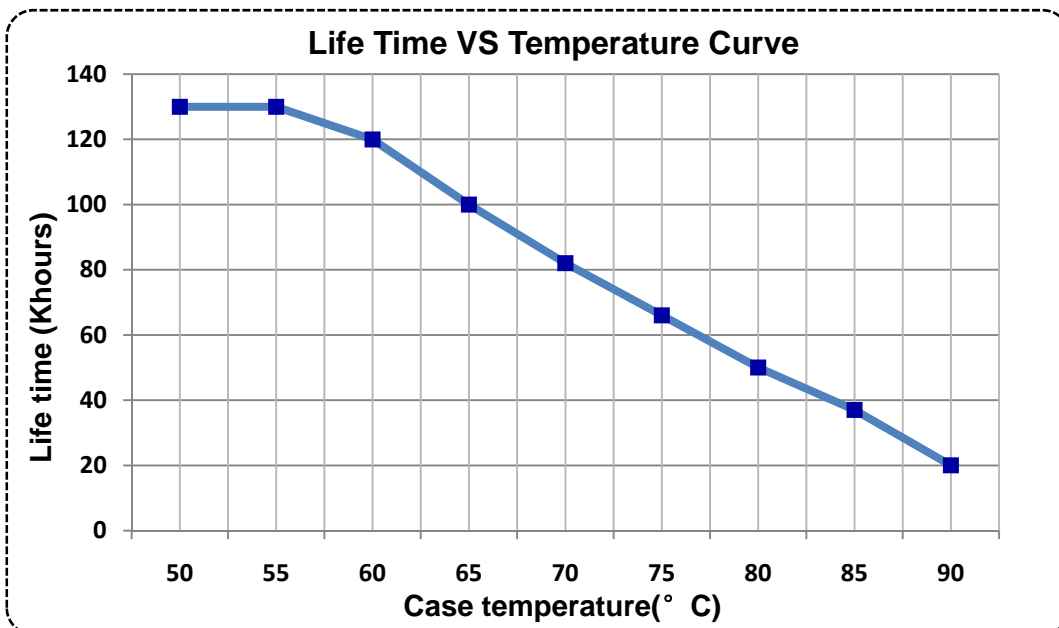

EFFICIENCY VS LOAD

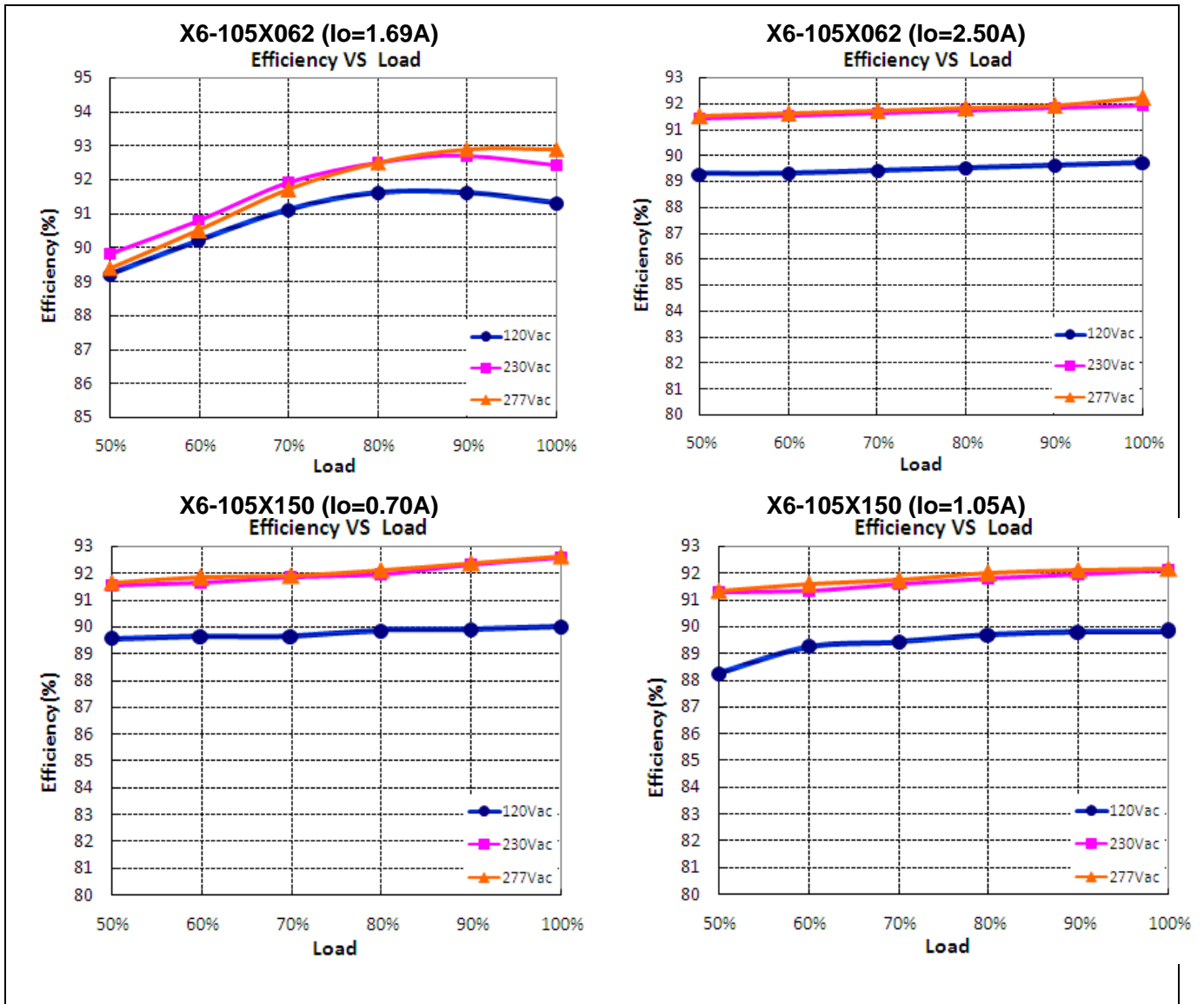

POWER FACTOR VS LOAD

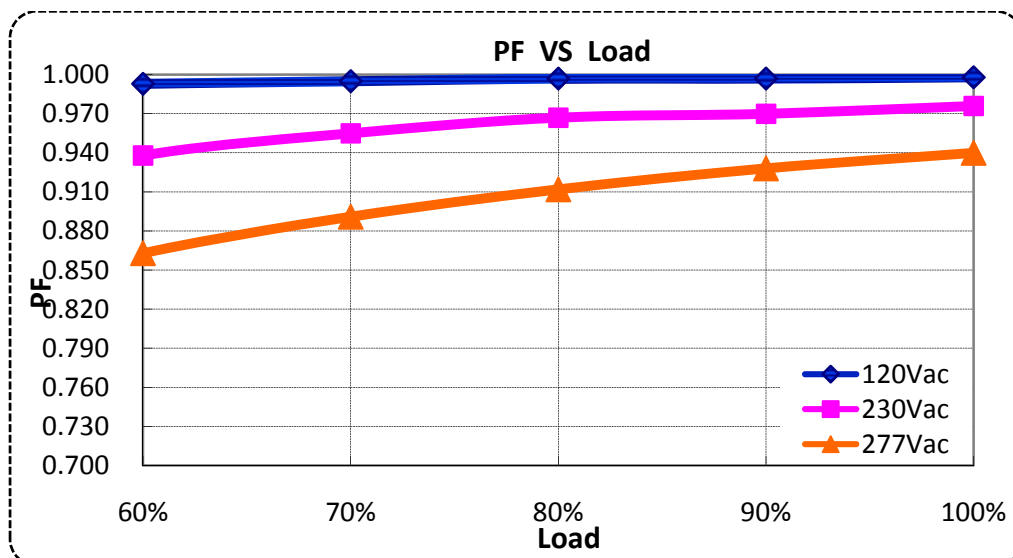

TOTAL HARMONIC DISTORTION

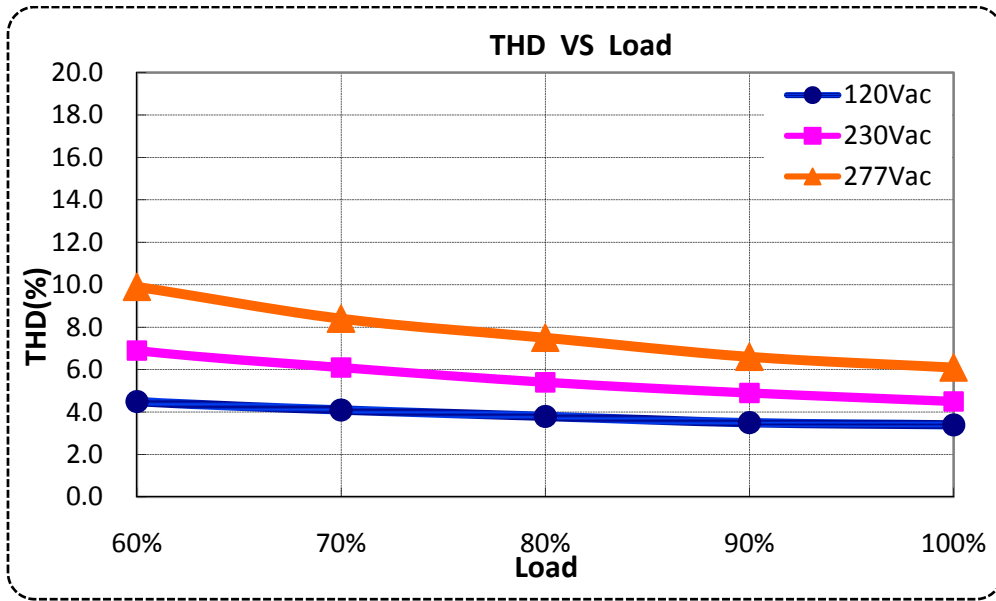

PROTECTIONS

Parameter	Notes
Over Temperature Protection	Decreases output current, returning to normal after over temperature is removed. The max derating could be 30% (typ.).
Short Circuit Protection	Hiccup mode and auto recovery. No damage will occur when any output is short circuited. The output shall return to normal when the fault condition is removed.
Over Voltage Protection	Run into protection model when output voltage exceeds limit, and return to normal when the fault

0-10V/PWM DIMMING

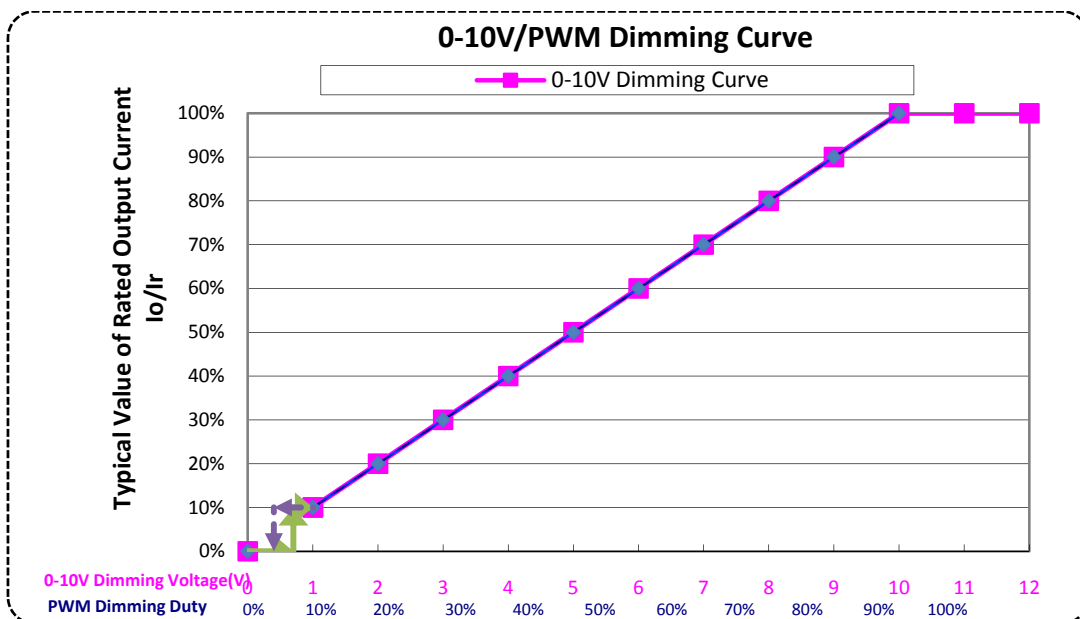

MECHANICAL OUTLINE

X6-105M types

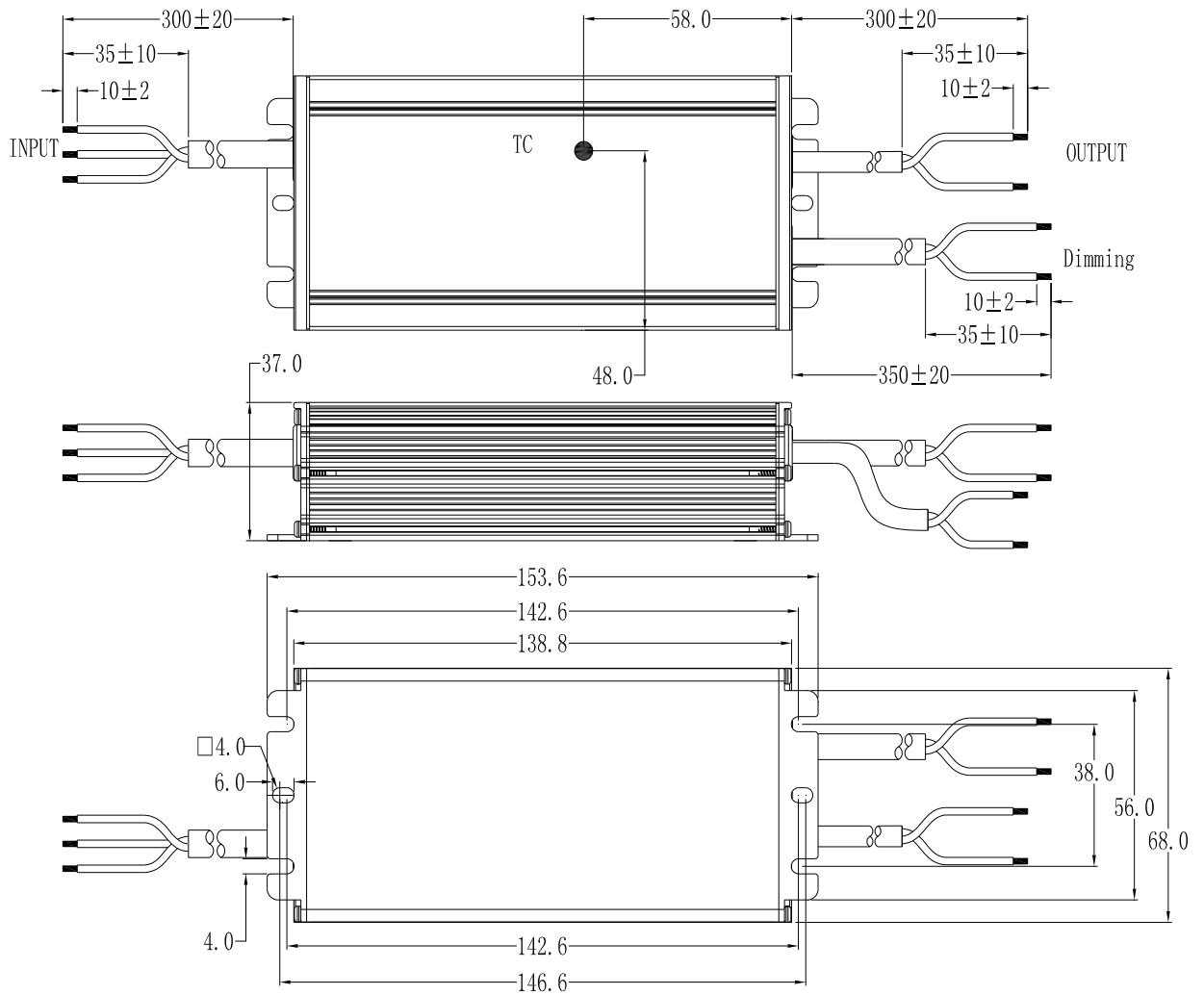

X6-105V types

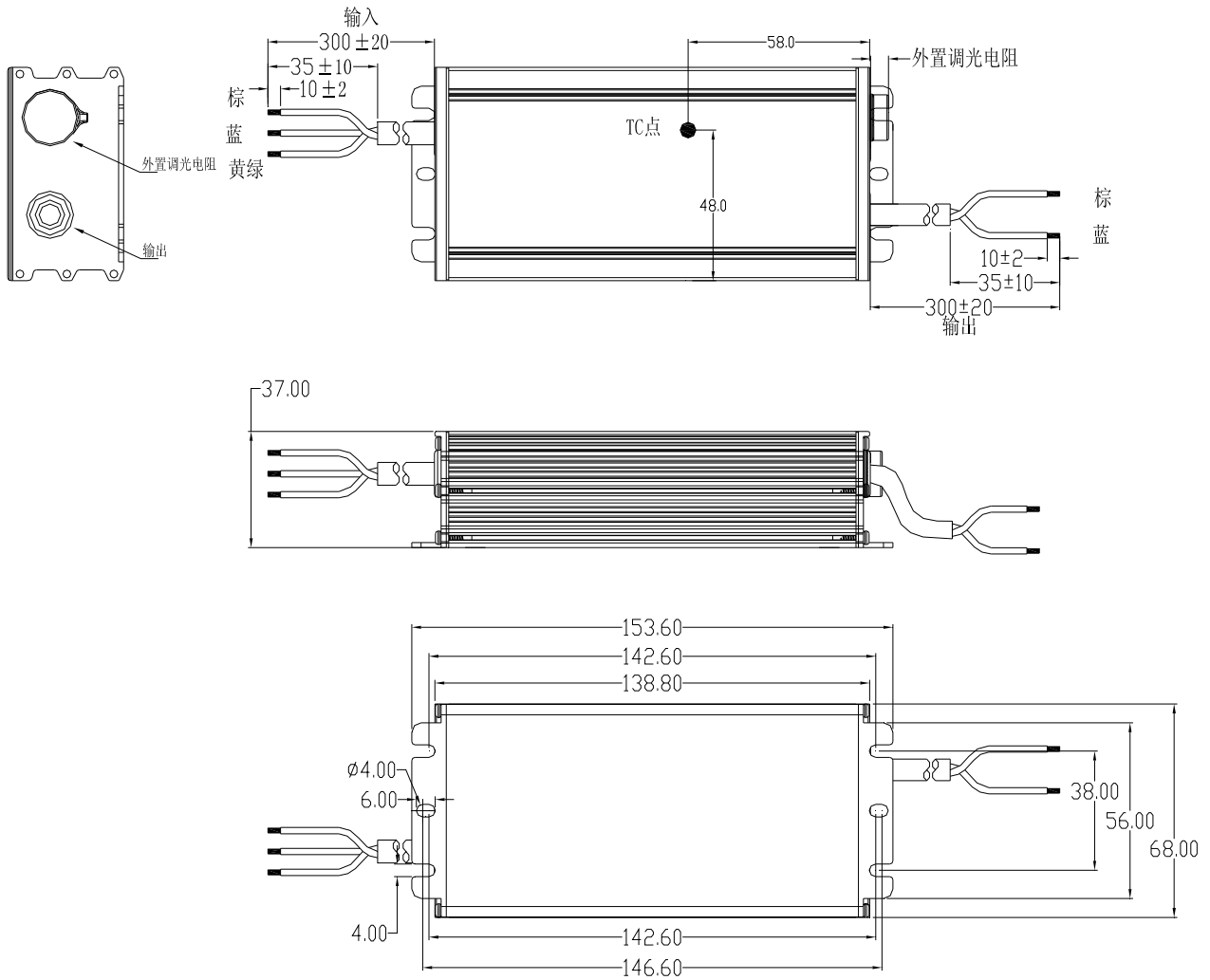

Wire	Specification	Note
Input	CCC+VDE H05RN-F 3*1.0mm ² external diameter: 7.3mm L=300±10mm, peel length 35mm, Tin-dip length 10mm	for CCC/CE
	18AWG*3C SJOW external diameter: 7.8mm L=300±10mm, peel length 35mm, Tin-dip length 10mm	for UL
Output	CCC+VDE H05RN-F 2*1.0mm ² external diameter: 7.0mm L=300±10mm, peel length 35mm, Tin-dip 10mm	for CCC/CE
	18AWG*2C SJOW external diameter: 7.3mm L=300±10mm, peel length 35mm, Tin-dip 10mm	for UL
Dimming	UL2733 22AWG*2C external diameter: 5.45mm L=350±10mm, peel length 35mm, Tin-dip 10mm	X = M

REVISION HISTORY

Version	Description of Change		Date	Notes
	Before	Now		
A.1	—	Datasheets Release	2019-03-16	