

Specification for Approval

Product Name: 60W Constant Current LED Driver
Product Model: X6-060M050
X6-060V050
Rev. A.1
Sample Date: -

CUSTOMER AUTHORIZED SIGNATURE		
Tested By	Checked By	Approved By
(Company seal)Return one copy to MOSO with approved signature and company seal.		

XiLi Songbai Road 1061, Nanshan
Address: District, Shenzhen City, Guangdong Province, P.R.China Post Code: 518108
TEL: 0755-27657000 FAX: 0755-27657908
E-mail: info@mosopower.com Web site: http://www.mosopower.com

Prepared By	Checked By	Approved By

Product Specification

Product Name: 60W Constant Current LED driver
Product Model: X6-060M050
 X6-060V050
Rev. A.1

XiLi Songbai Road 1061, Nanshan
Address: District, Shenzhen City, Guangdong Post Code: 518108
Province, P.R.China
TEL: 0755-27657000 FAX: 0755-27657908
E-mail: info@mosopower.com Web site: <http://www.mosopower.com>

Prepared By	Checked By	Approved By



Product Features:

- Input voltage range: 90~305Vac;
- Constant current design;
- V types output current adjustable;
- THD<10%;
- 2-in-1 dimmable: 1~10Vdc, PWM dimming;
- Output and Dimming Signal Isolating;
- Surge protection:4KV line-line, 6KV line-earth;
- Protections: Input OVP, Output OVP, SCP;
- IP67 design for indoor and outdoor applications;
- Suitable for dry / damp / wet locations;
- 5 years warranty.

Application:

- Suitable for LED roadway lighting, plant lighting, industrial lighting, landscape lighting, etc.

DESCRIPTION

The X6-60W is a 60W, constant-current, IP67 LED driver that operates from 90-305Vac input with excellent power factor and low THD. It is created for industrial lights, tunnel and street lights. The high efficiency of these drivers and compact metal case enable them to run cooler, significantly improving reliability and extending product life. To ensure trouble-free operation, protection is provided against input surge, input over voltage, output over voltage, and short circuit.

MODELS

Model Number[1]	Input voltage range(Vac)	Max Output Power (W)	Output Voltage Range (Vdc)	Output current (A)	Typical Efficiency	Typical THD	Typical PF	
							120Vac	230Vac
X6-060Y050	90-305	60W	25-50	1.2	87%	10%	0.99	0.96

Notes:

[1]. Y can be M or V. Y=M means dimmable and constant current output;

Y=V means non-dimmable and output current adjusted by built-in potentiometer, 50%-100%Imax;

[2]. All specifications are measured at 25°C ambient temperature, input voltage 230Vac, and the typical value tested by full load, if no specific note.

INPUT SPECIFICATIONS

Parameter	Min.	Typ.	Max.	Notes
Input Voltage	90Vac	100-277Vac	305Vac	
Input Frequency	47Hz	50/60	63Hz	
Leakage Current	-	-	0.70mA	277Vac/60Hz
Input AC Current	-	-	0.8A	100-277Vac & full load
Inrush Current	-	-	0.15A ² S	230Vac input, Ta=25°C (cold start)
Power Factor	0.97	0.99	-	120Vac, 50-60Hz, full load
	0.95	0.96	-	230Vac, 50-60Hz, full load
	0.90	0.92	-	277Vac, 50-60Hz, full load
THD	-	5%	10%	100-240Vac, 50-60Hz, 70%-100% load
	-	-	20%	277Vac, 50-60Hz, 70%-100% load

OUTPUT SPECIFICATIONS

Parameter	Min.	Typ.	Max.	Notes
Output Current Tolerance	-8%	-	8%	
Output Current Setting Range (A) X6-060V050	0.6	-	1.2	
Total Output Current Ripple(pk-pk)	-	50%	120%	20MHz BW, full load & LED load, the ripple would be tiny different under different LED load.
Startup Overshoot Current	-	5%	10%	100~277Vac & 100% Load, load is LED
No Load Output Voltage(V) X6-060Y050	-	-	70	
Line Regulation	-8%	-	8%	25°C±10°C ambient temperature, input voltage changes from 100Vac to 277Vac.
Load Regulation	-8%	-	8%	25°C±10°C ambient temperature, Input Voltage 230Vac, load changes from 60% to 100%.
Turn-on Delay Time	-	1S	3S	120Vac, 100% load
	-	0.5S	1S	230Vac, 100% load

GENERAL SPECIFICATIONS

Parameter		Min.	Typ.	Max.	Notes
Efficiency @120Vac X6-060Y050		85%	87%		Measured at full load and 25°C ambient temperature
Efficiency @230Vac X6-060Y050		86%	88%		Measured at full load and 25°C ambient temperature
Efficiency @277Vac X6-060Y050		85%	87%		Measured at full load and 25°C ambient temperature
Dielectric Strength	Input-Output	-	3750Vac	-	Max 5mA/60S
	Input-PE	-	1600Vac	-	
	Output-PE	-	1600Vac	-	
Grounding Resistance		-	-	0.1Ω	25A/60S, under 25°C±10°C ambient temperature
Insulation Resistance		50MΩ	-	-	Input-Output, Input-PE, Output-PE, 500Vdc/60S/25°C/70%RH
MTBF		-	200000Hrs	-	25°C±10°C ambient temperature, 230Vac, 80% load (MIL-HDBK-217F)
Lifetime		-	50000Hrs	-	230Vac&100% load, 75°C case temperature, refer to lifetime curve for details
Operating Case Temperature for Safety Tc_s		-40°C	-	+90°C	
Operating Case Temperature for Warranty Tc_s		-40°C	-	+75°C	5 years warranty case temperature Humidity: 10% to 95% RH
Storage Temperature		-40°C	-	+85°C	Humidity: 5% to 100% RH
Dimensions (L*W*H)mm		L107*W64*H33			
Net Weight		400± 50g/PCS			
Package		L480mm*W275mm*H208mm; 24PCS/Ctn, Gross Weight: 12Kg			

DIMMING

Parameter		Min.	Typ.	Max.	Notes
0~10V Absolute Maximum Voltage on the Vdim (+) Pin		-	10V	-	
0~10V Source Current on Vdim(+)Pin		-	1mA	2mA	
Dimming Output Range	X6-060M050	10%Imax	-	100%Imax	Imax=1.2A
	X6-060M050	0.12	-	1.2	
Recommended Dimming Range for 0-10V		0V	-	10V	Default 0-10V/ PWM Dimming
PWM_in High Level		9.7V	-	10.3V	
PWM_in Low Level		0V	-	0.3V	
PWM_in Frequency Range		300Hz	-	2KHz	
PWM_in Duty Cycle		1%	-	99%	

SAFTY STANDARDS

Safety Category	Country / Territory	Standards	Approved
CCC	China	GB19510.1, GB19510.14	√
CE	Europe	EN61347-1, EN61347-2-13	√
		EN62493	√
		EN62384	√
CB	CB Countries	IEC61347-1, IEC61347-2-13	√
BIS	India	IS 15885(PART 2/SEC 13)	
UL	USA	UL 8750	√
CUL	Canada	CSA C22.2 No.250.13	√
KC	South Korea	K61347-1, K61347-2-13	
PSE	Japan	J61347-1, J61347-2-13	
SAA	Australia	AS/NZS IEC 61347.2.13	√
		AS/NZS 61347.1	√

EMC COMPLIANCE

EMC Category	Country / Territory	Standards	Approved
CCC	China	GB/T 17743, GB 17625.1	√
CE	Europe	EN 55015	√
		EN 61000-3-2, EN 61000-3-3	√
		EN61000-4-2,3,4,5,6,11	√
		EN 61547	√
KC	South Korea	K61547	
		K00015	
PSE	Japan	J55015	
FCC	USA	FCC part 15	

NOTE:

This LED driver meets the EMI specifications above, but as a component of a luminaire, end customer need to identify the EMI performance of a luminaire including LED driver, other devices connected to the driver and on the luminaire itself.

INRUSH CURRENT WAVEFORM

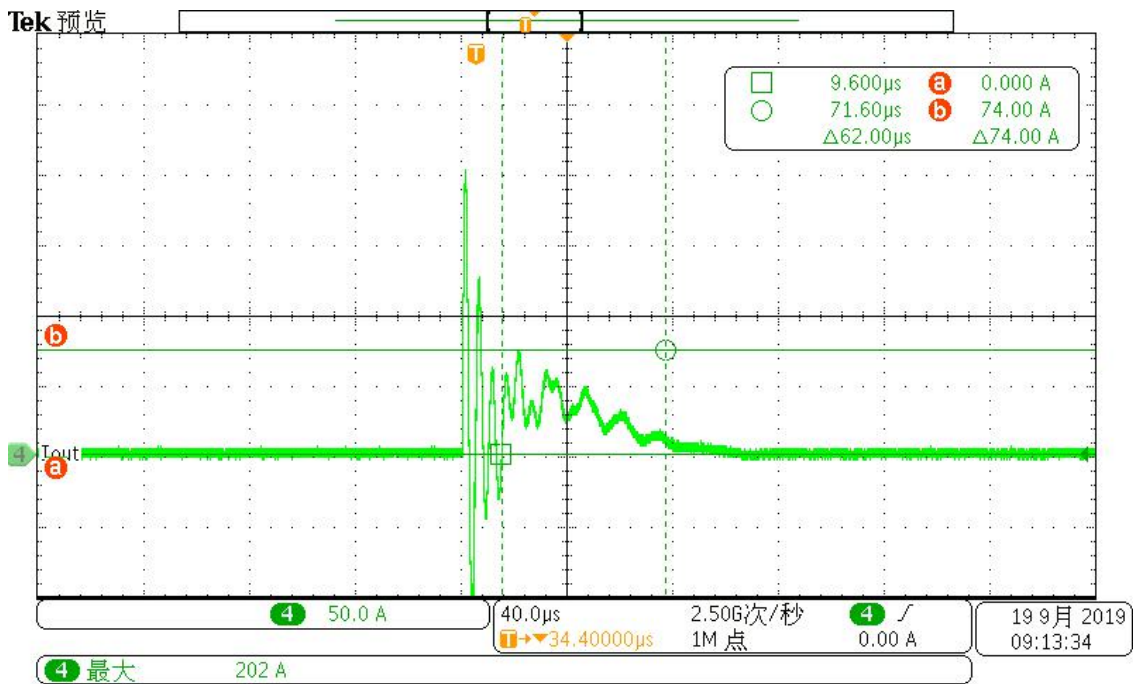

DERATING CURVE

Derating Curve

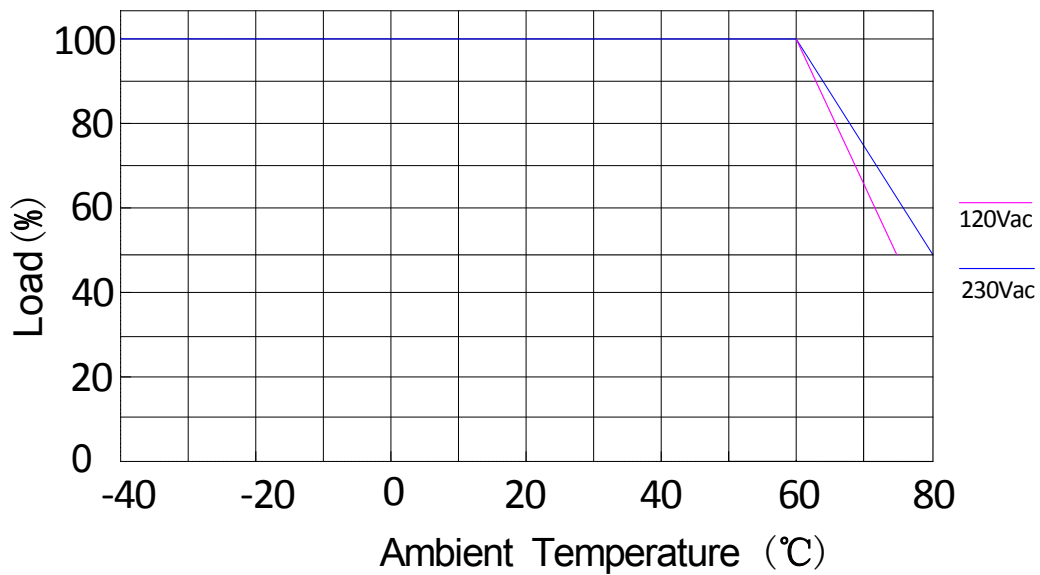

OUTPUT POWER VS INPUT VOLTAGE

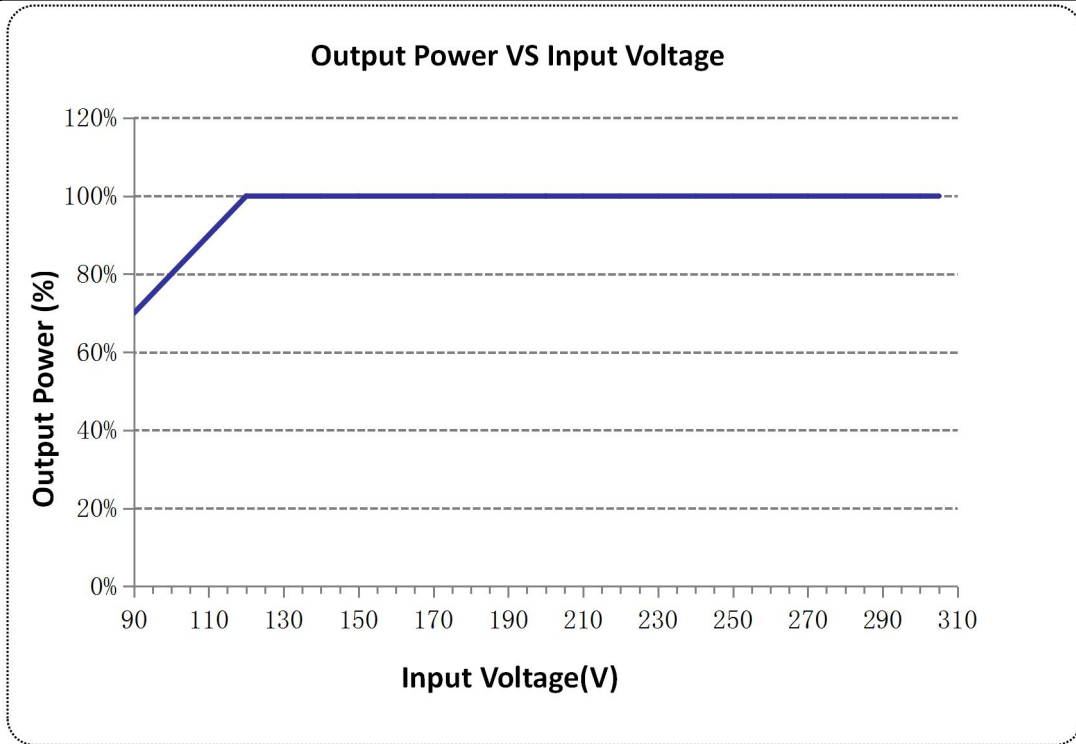

LIFETIME VS CASE TEMPERATURE

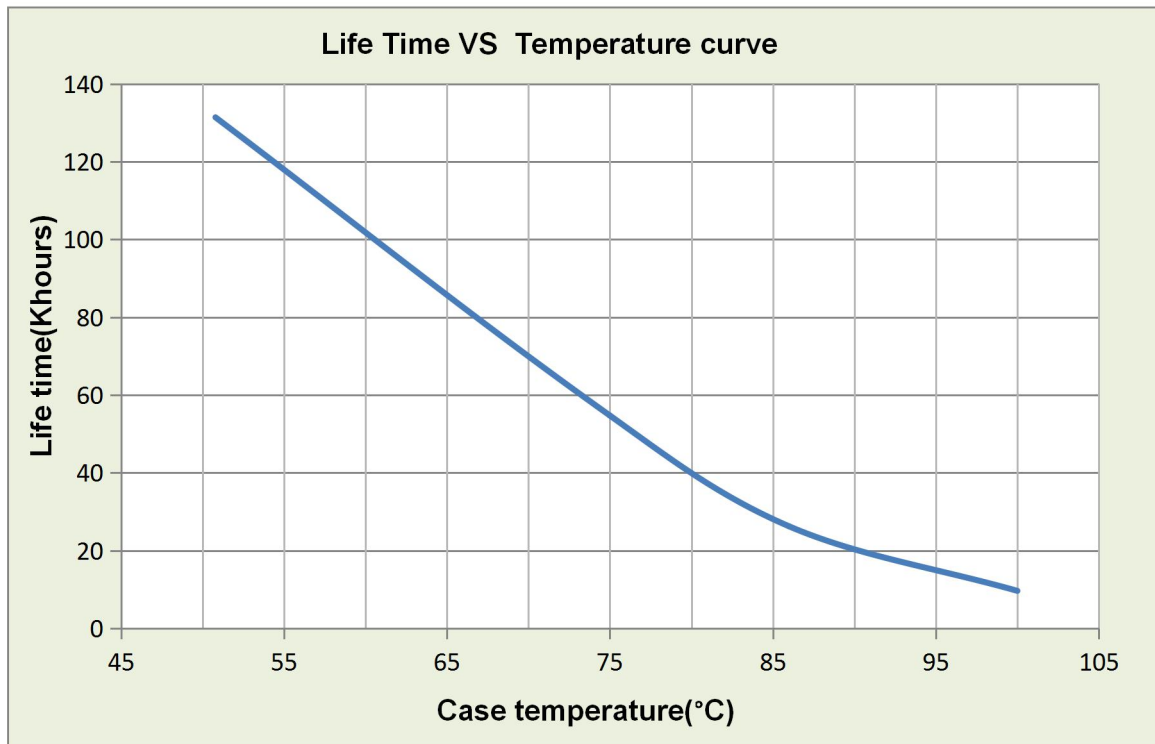

EFFICIENCY VS LOAD

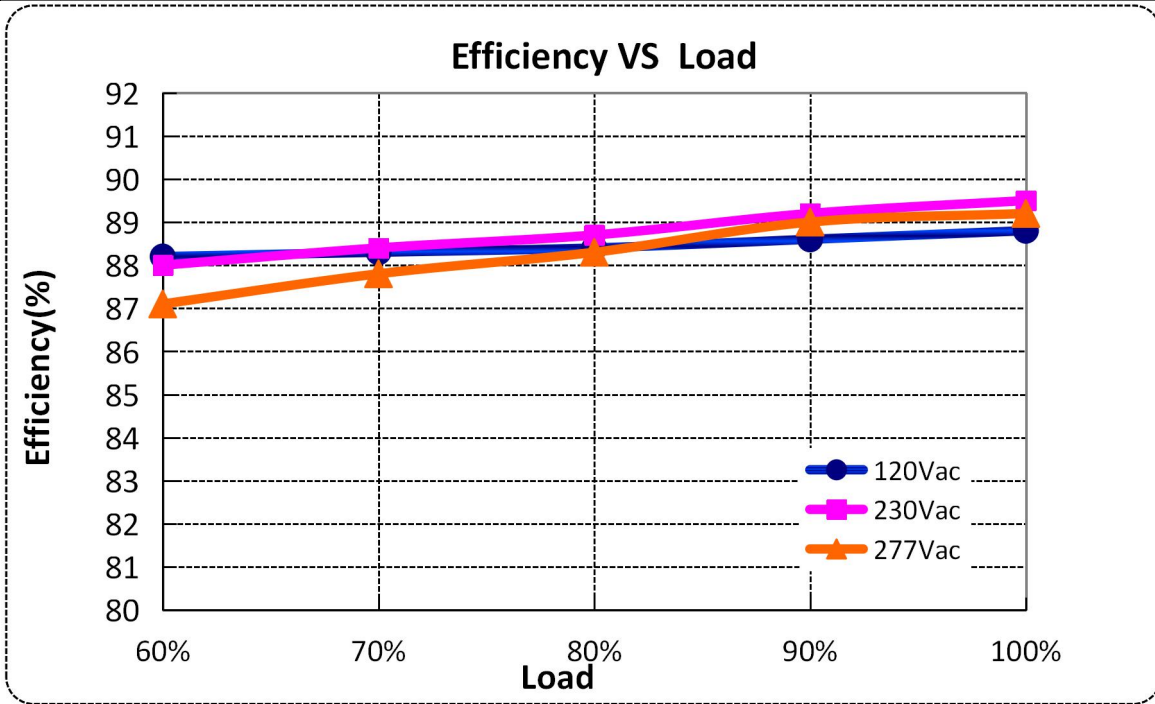

POWER FACTOR VS LOAD

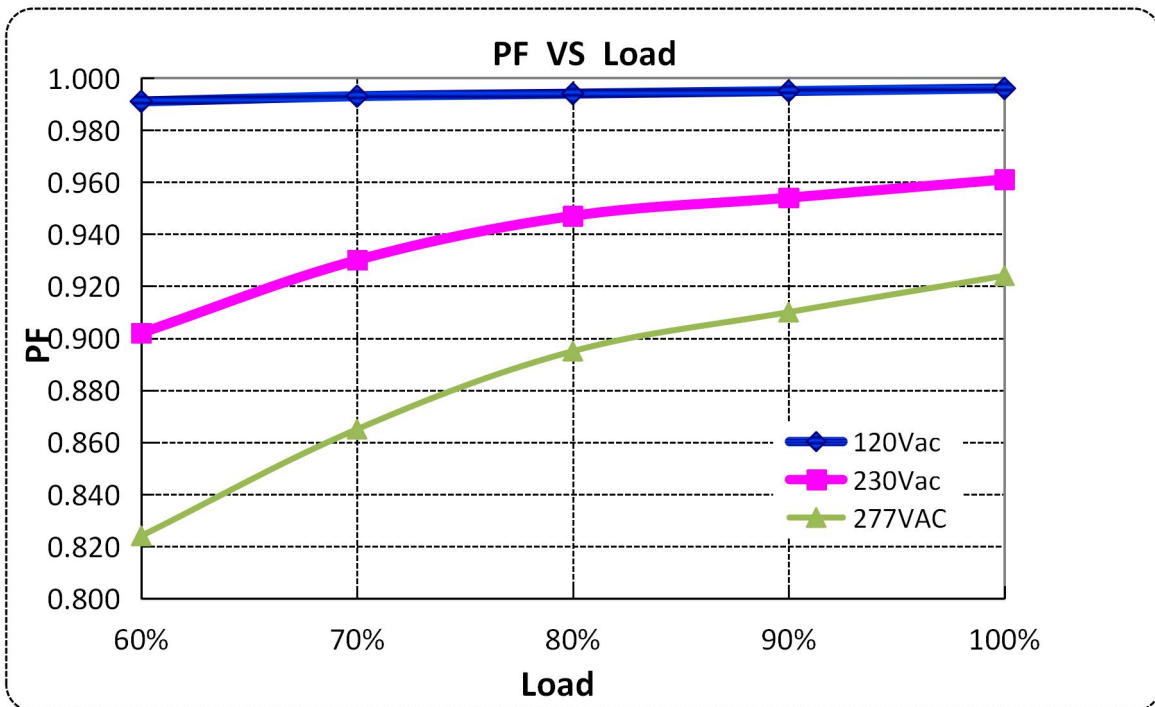

TOTAL HARMONIC DISTORTION

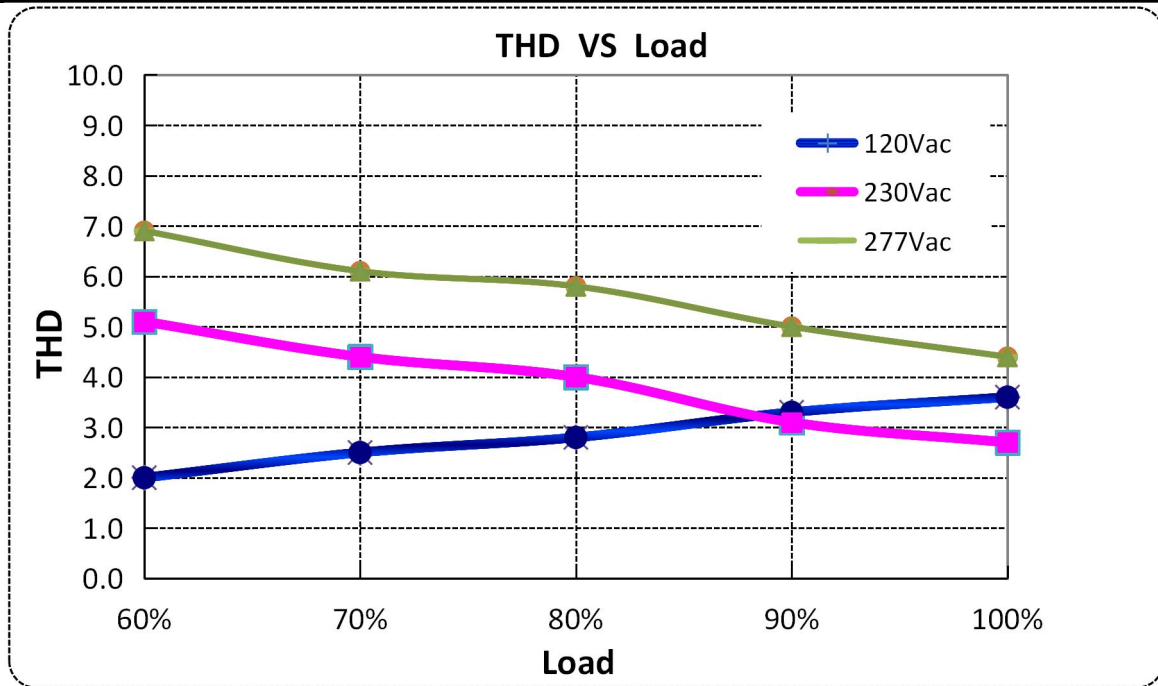

PROTECTIONS

Parameter		Min.	Typ.	Max.	Notes
Input Over Voltage Protection	Input Protection Voltage	320Vac	340Vac	350Vac	Turn off the output when the input voltage exceeds protection voltage.
	Recovery Voltage	300Vac	320Vac	340Vac	Auto Recovery. The driver will restart when the input voltage falls below recovery voltage.
Output Over Voltage Protection		Limits output voltage at no load and in case the normal voltage limit fail			
Short Circuit Protection		Hiccup mode and auto recovery. No damage will occur when any output is short circuited. The output shall return to normal when the fault condition is removed.			

1-10V/PWM DIMMING

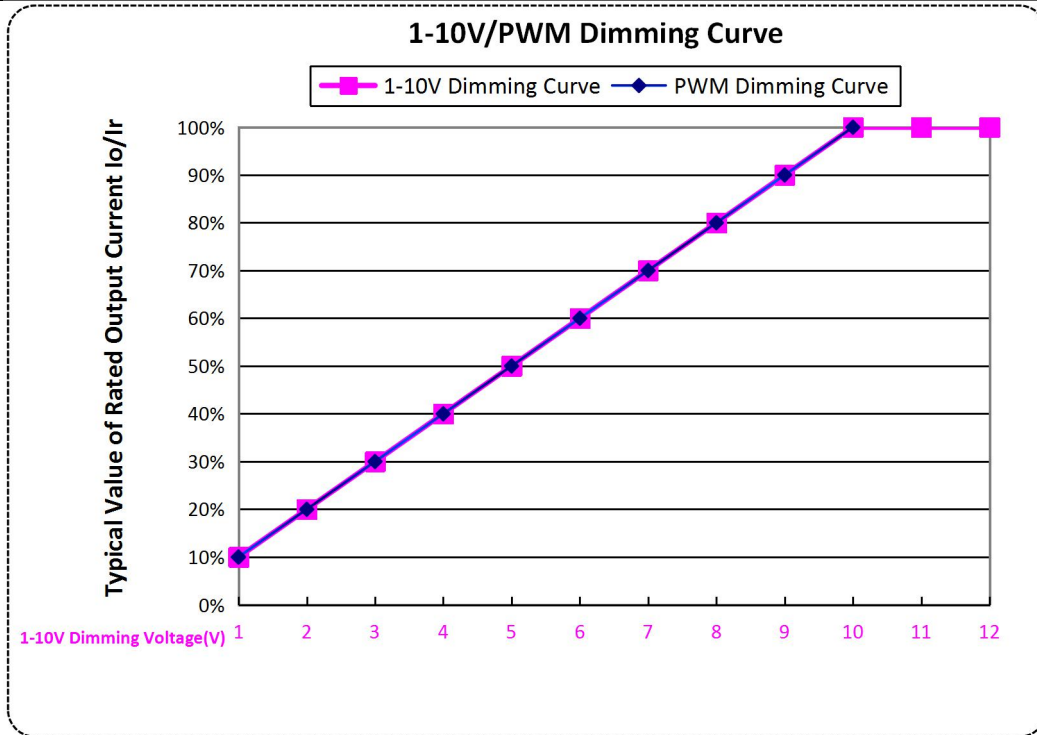

MECHANICAL OUTLINE

X6-060M types

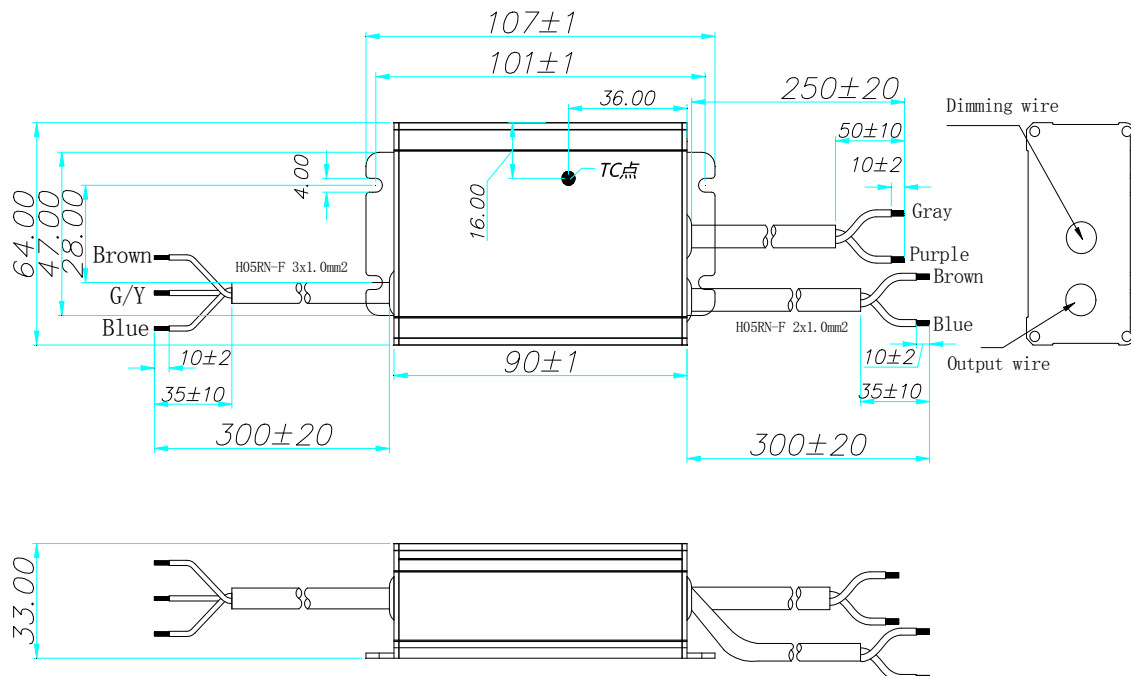

X6-060V types

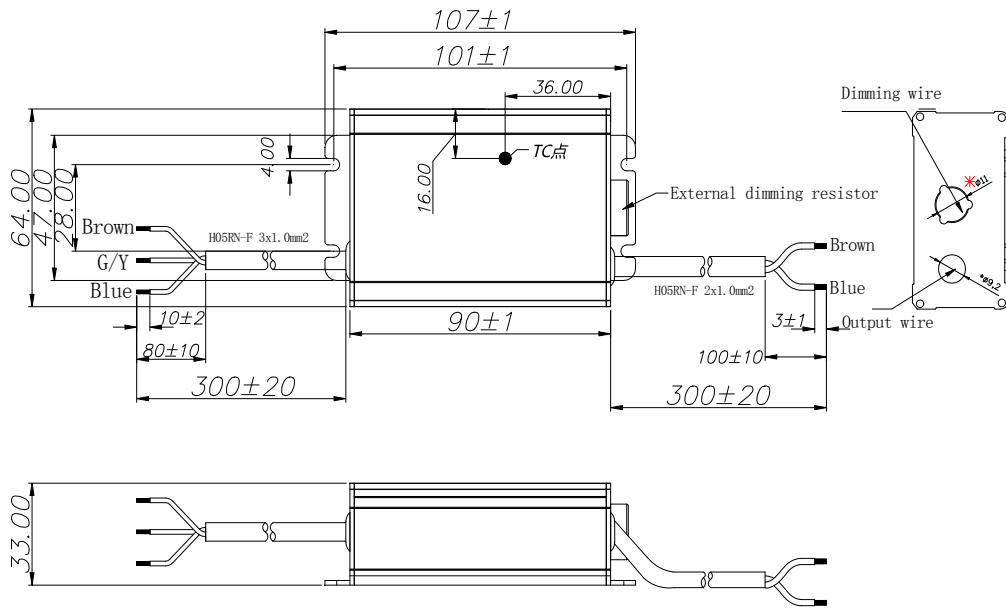

Wire	Specification	Note
Input	17AWG*3C SJOW external diameter: 8.3mm L=300±20mm, peel length 35mm, Tin-dip length 10mm	for CCC/CE/UL
Output	17AWG*2C SJOW external diameter: 7.7mm L=300±20mm, peel length 35mm, Tin-dip length 10mm	for CCC/CE/UL
Dimming	UL2733 22AWG*2C external diameter: 5.45mm L=250±10mm, peel length 35mm, Tin-dip 10mm	

LABEL:

82.00 mm

45.00 mm

MOSO[®] X6-060M050

LED DRIVER
LED 控制装置(恒流型)

OUTPUT

(PURPLE 紫) DIM +

(GRAY 灰) DIM -

(BROWN 棕) Vo +





(BLUE 蓝) Vo -

INPUT (输入)	100-240V~ 50/60Hz, 0.8A Max. PF:0.95 277V~ 50/60Hz, 0.4A Max (277V~ for North America only)
OUTPUT (输出)	25-50V--- 0.12-1.2A Max.(最大电压): 70V--- Max.Power(最大功率):60W
t_c: 90°C	t_a: 60°C Input:100-240V~ 277V~

L (BROWN 棕)

G (Y/G 黄/绿)

N (BLUE 蓝)

CE

CULUS
E33289
Type HL

ELV
18

IP67

RoHS

SELV

MADE IN CHINA
For LED module only

Suitable for Dry, Damp and Wet locations
SHENZHEN MOSO ELECTRONICS TECHNOLOGY CO., LTD
No.1061, Songbai Road, Xili Town, Nanshan District,
Shenzhen, CHINA

82.00 mm

45.00 mm

MOSO[®] X6-060V050

LED DRIVER
LED 控制装置(恒流型)

OUTPUT

I_o ADJ (+)

(BROWN 棕) Vo +

(BLUE 蓝) Vo -

INPUT (输入)	100-240V~ 50/60Hz, 0.8A Max. PF:0.95 277V~ 50/60Hz, 0.4A Max (277V~ for North America only)
OUTPUT (输出)	25-50V--- 0.6-1.2A Max.(最大电压): 70V--- Max.Power(最大功率):60W
t_c: 90°C	t_a: 60°C Input:100-240V~ 277V~

L (BROWN 棕)

G (Y/G 黄/绿)

N (BLUE 蓝)







CE

CULUS
E33289

ELV
18

SELV

IP67

RoHS

MADE IN CHINA
For LED module only

Suitable for Dry, Damp and Wet locations
SHENZHEN MOSO ELECTRONICS TECHNOLOGY CO., LTD
No.1061, Songbai Road, Xili Town, Nanshan District,
Shenzhen, CHINA