

EMILY-WW

~45° wide beam. 14.74 mm high lens.

TECHNICAL SPECIFICATIONS:

Dimensions	Ø 26.0 mm
Height	14.7 mm
Fastening	tape, pin
ROHS compliant	yes ⓘ

MATERIAL SPECIFICATIONS:

Component	Type	Material	Colour	Finish
EMILY-WW	Single lens	PMMA	clear	
SPUTNIK-TAPE	Tape	Acrylic foam	black	

ORDERING INFORMATION:



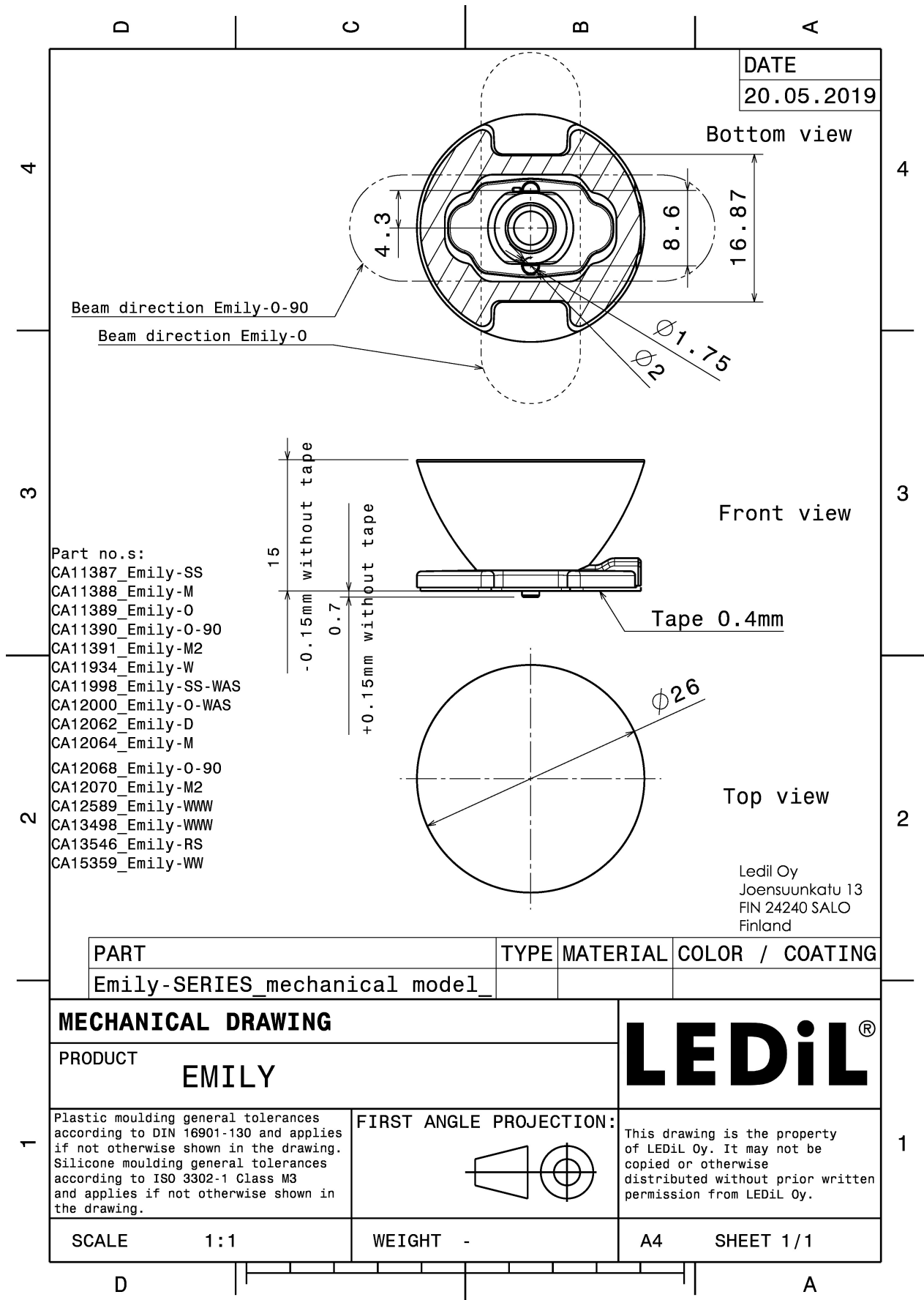

Component		Qty in box	MOQ	MPQ	Box weight (kg)
CA15359_EMILY-WW	Single lens	1690	260	130	11.3
» Box size: 480 x 280 x 300 mm					



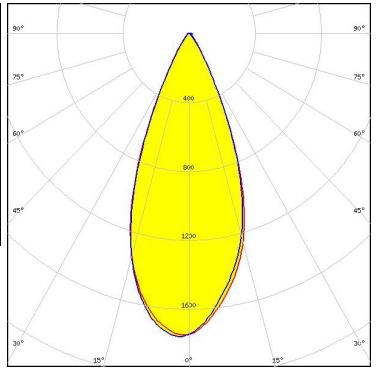

See also our general installation guide: www.ledil.com/installation_guide

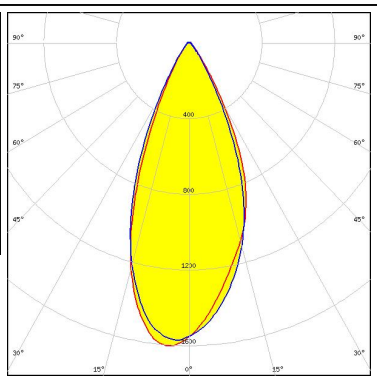
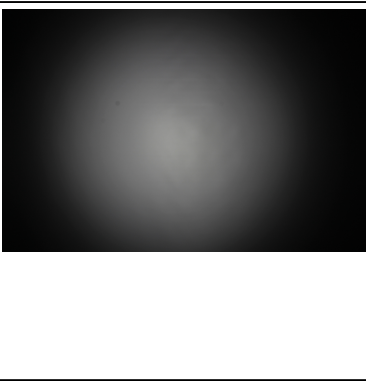
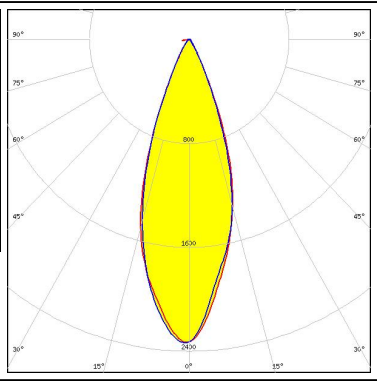
PHOTOMETRIC DATA (MEASURED):

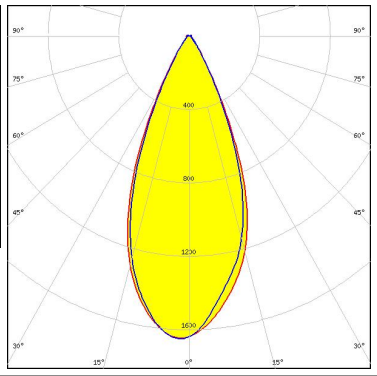
<p>CREE LED</p> <p>LED: XP-L HI FWHM / FWTM: 42.0° / 65.0° Efficiency: 93 % Peak intensity: 1.8 cd/m LEDs/each optic: 1 Light colour: White Required components:</p>		
<p>NICHIA</p> <p>LED: NVSW219F FWHM / FWTM: 44.0° / 69.0° Efficiency: 92 % Peak intensity: 1.6 cd/m LEDs/each optic: 1 Light colour: White Required components:</p>		
<p>OSRAM <small>Opto Semiconductors</small></p> <p>LED: OSLOM Black Flat FWHM / FWTM: 35.0° / 57.0° Efficiency: 92 % Peak intensity: 2.3 cd/m LEDs/each optic: 1 Light colour: White Required components:</p>		
<p>OSRAM <small>Opto Semiconductors</small></p> <p>LED: OSLOM Square CSSRM2/CSSRM3 FWHM / FWTM: 44.0° / 67.0° Efficiency: 93 % Peak intensity: 1.7 cd/m LEDs/each optic: 1 Light colour: White Required components:</p>		

PHOTOMETRIC DATA (MEASURED):

SAMSUNG

LED LH181B
 FWHM / FWTM 35.0° / 59.0°
 Efficiency 93 %
 Peak intensity 2.2 cd/lm
 LEDs/each optic 1
 Light colour White
 Required components:

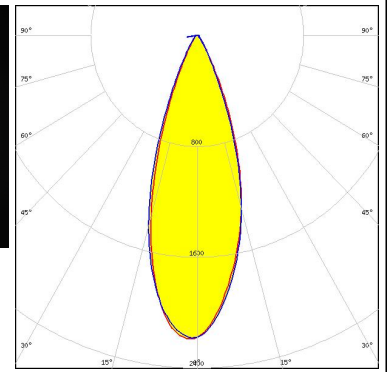





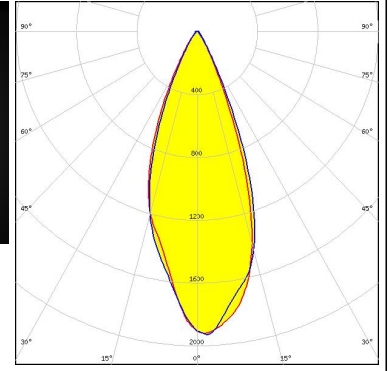

SEOUL SEMICONDUCTOR

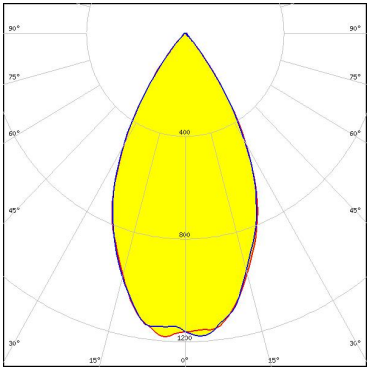
LED nPola
 FWHM / FWTM 50.0° / 85.0°
 Efficiency 92 %
 Peak intensity 1.1 cd/lm
 LEDs/each optic 1
 Light colour White
 Required components:

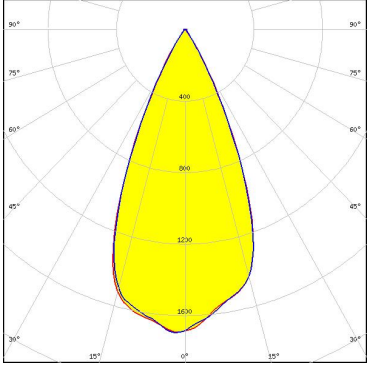

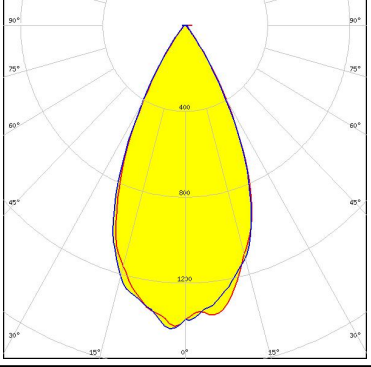
PHOTOMETRIC DATA (SIMULATED):

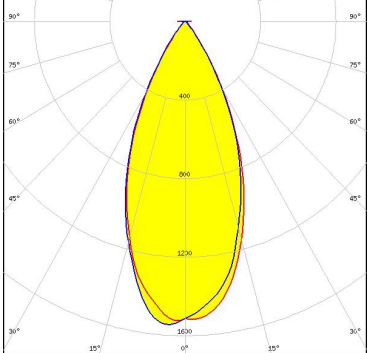
	<p>LED XHP35 HD FWHM / FWTM 55.0° / 80.0° Efficiency 96 % Peak intensity 1.2 cd/lm LEDs/each optic 1 Light colour White Required components:</p>	
	<p>LED XP-E2 FWHM / FWTM 46.0° / 64.0° Efficiency 97 % Peak intensity 1.7 cd/lm LEDs/each optic 1 Light colour White Required components:</p>	
	<p>LED XP-G2 HE FWHM / FWTM 50.0° / 72.0° Efficiency 96 % Peak intensity 1.4 cd/lm LEDs/each optic 1 Light colour White Required components:</p>	
	<p>LED XP-L2 FWHM / FWTM 46.0° / 73.0° Efficiency 94 % Peak intensity 1.6 cd/lm LEDs/each optic 1 Light colour White Required components:</p>	

PHOTOMETRIC DATA (SIMULATED):

LUMILEDS

LED LUXEON HL2X
 FWHM / FWTM 49.0° / 72.0°
 Efficiency 96 %
 Peak intensity 1.5 cd/lm
 LEDs/each optic 1
 Light colour White
 Required components:

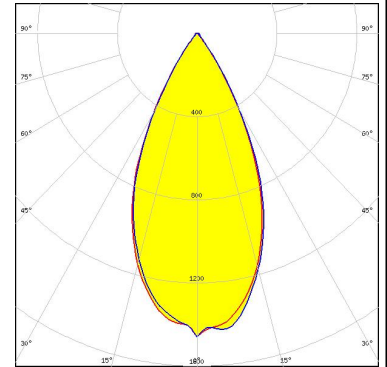

LUMILEDS

LED LUXEON MZ
 FWHM / FWTM 39.0° / 64.0°
 Efficiency 96 %
 Peak intensity 2.1 cd/lm
 LEDs/each optic 1
 Light colour White
 Required components:

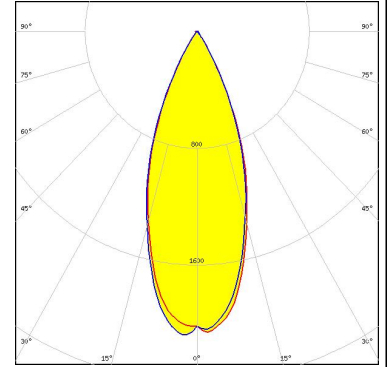

NICHIA

LED NCSxE17A
 FWHM / FWTM 37.0° / 62.0°
 Efficiency 90 %
 Peak intensity 1.9 cd/lm
 LEDs/each optic 4
 Light colour White
 Required components:

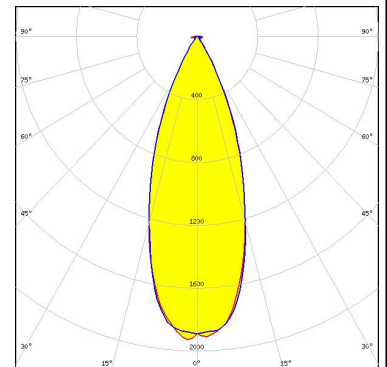
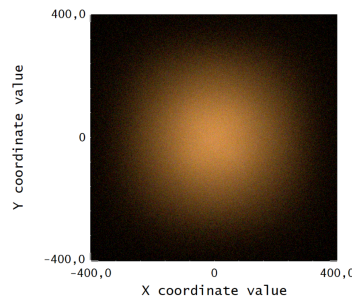

OSRAM

Opto Semiconductors
 LED OSOLON SSL 150
 FWHM / FWTM 44.0° / 64.0°
 Efficiency 97 %
 Peak intensity 1.9 cd/lm
 LEDs/each optic 1
 Light colour White
 Required components:

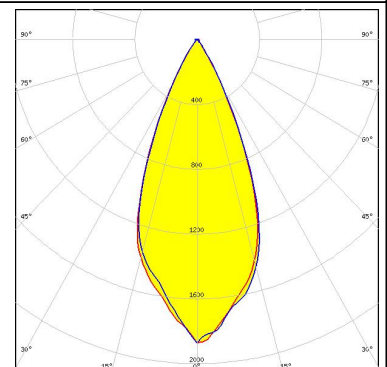

PHOTOMETRIC DATA (SIMULATED):

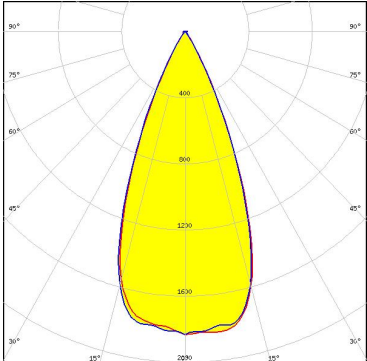
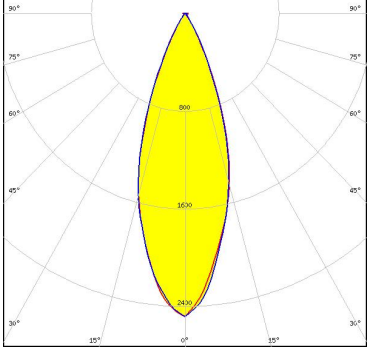
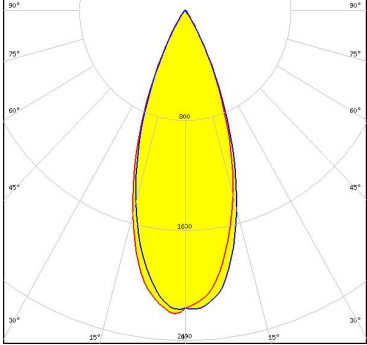
<p>OSRAM Opto Semiconductors</p> <p>LED OSLON SSL 80</p> <p>FWHM / FWTM 44.0° / 62.0°</p> <p>Efficiency 97 %</p> <p>Peak intensity 1.8 cd/lm</p> <p>LEDs/each optic 1</p> <p>Light colour White</p> <p>Required components:</p>	
<p>OSRAM Opto Semiconductors</p> <p>LED SFH 4716AS</p> <p>FWHM / FWTM 35.0° / 58.0°</p> <p>Efficiency 97 %</p> <p>LEDs/each optic 1</p> <p>Light colour IR</p> <p>Required components:</p>	
<p>SEOUL SEMICONDUCTOR</p> <p>LED Z5M4</p> <p>FWHM / FWTM 39.0° / 62.0°</p> <p>Efficiency 97 %</p> <p>Peak intensity 2.2 cd/lm</p> <p>LEDs/each optic 1</p> <p>Light colour White</p> <p>Required components:</p>	

GENERAL INFORMATION:

NOTE: The typical beam angle will be changed by different color, chip size and chip position tolerance. The typical total beam angle is the full angle measured where the luminous intensity is half of the peak value.

MATERIALS:

As part of our continuous research and improvement processes, and to ensure the best possible quality and availability of our products, LEDiL reserves the right to change material grades without notice.

PRODUCT DATA USER AGREEMENT AND DISCLAIMER:

The measured data in the provided downloadable LEDiL Product Datasheets and Mechanical 2D-Drawings is rounded and provided as reference for planning. LEDiL Oy's optical specifications have been verified by conducting performance testing of the products in accordance with the company's quality system. The reported data are averaged results of multiple measurements with typical variation. LEDiL Oy reserves the right to without prior notification make changes and improvements to its products.

LEDiL Oy assumes neither warranty, nor guarantee nor any other liability of any kind for the contents and correctness of the provided data. The provided data has been generated with highest diligence but the provided data may in reality not represent the complete possible variation range of all intrinsic parameters. Therefore, in certain cases a deviation from the provided data could occur.

LEDiL Oy reserves the right to undertake technical changes of its products without further notification which could lead to changes in the provided data. LEDiL Oy assumes no liability of any kind for the possible deviation from any provided data or any other damage resulting from the usage of the provided data.

The user agrees to this disclaimer and user agreement with the download or usage of the provided files.

LEDiL Oy

Joensuunkatu 13
FI-24240 SALO
Finland

LEDiL Inc.

228 West Page Street
Suite D
Sycamore IL 60178
USA

Ledil Optics Technology (Shenzhen) Co., Ltd.

405 , Block B
Casic Motor Building
Shenzhen 518057
P.R.CHINA

Local sales and technical support

[www.ledil.com/
where_to_buy](http://www.ledil.com/where_to_buy)

Shipping locations

Salo, Finland
Hong Kong, China

Distribution Partners

[www.ledil.com/
where_to_buy](http://www.ledil.com/where_to_buy)