

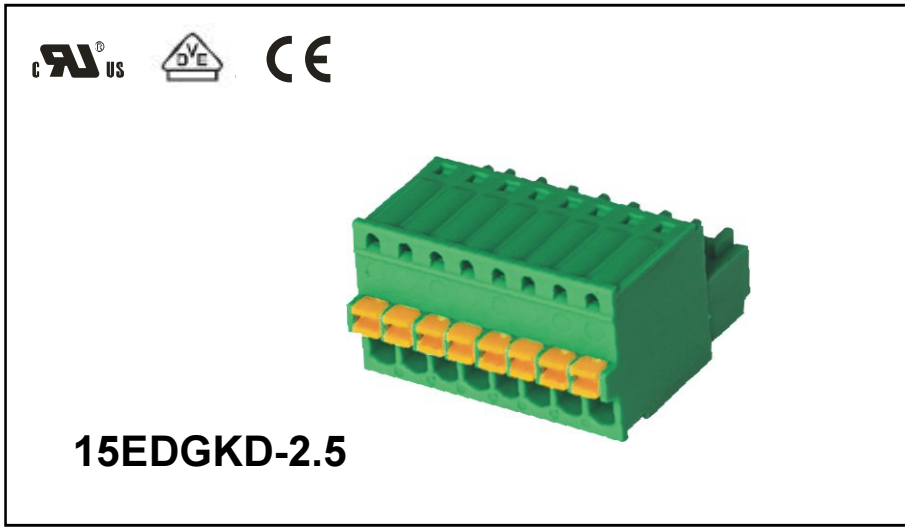

DEGSON ELECTRONICS CO., LTD.

Product Specification



APPROVAL		
Electrical		
Standard	UL	IEC
Rated voltage	150V	250V
Rated current	4A	5A
Wire range	20AWG	0.2-1.5mm ²
Withstanding voltage	AC1500V/1Min	
Mechanical		
Ambient temperature	-40°C~+105 °C	
Strip length	8mm	
Dimensions		
Pitch	2.5mm(.098")	
Poles	2P-12P	
Material		
Housing	PA66,UL94V-0	
Contact	Phosphor bronze	
Wire guard	Stainless steel	

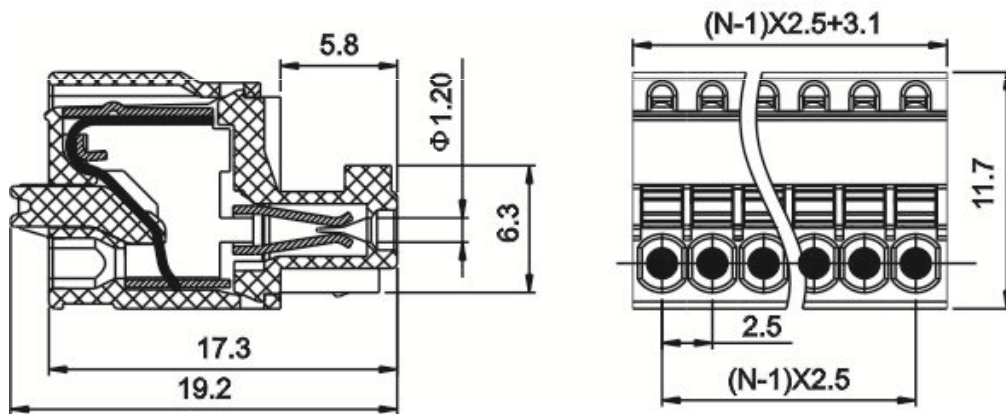

HOW TO ORDER :

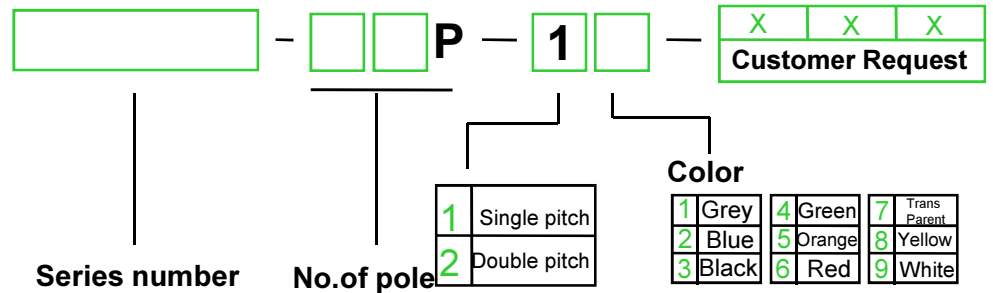

	DEGSON ELECTRONICS CO., LTD.
	NAME 15EDGKD-2.5