

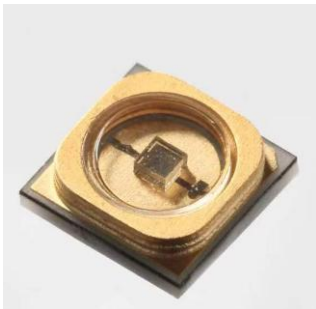

Part No.: U3535C2VGB30

Product picture



Product introduction

This series of deep uv packaging products are specially designed for applications with high radiation power and directivity requirements. The surface of the packaging body in the form of a patch device, and the use of special uv glass, so as to optimize the product life and performance. It can be used in plant lighting, fluorescence analyzer, medical testing, food and pharmaceutical processing, sterilization and other fields.

Features

- ✧ Ceramic packaging
- ✧ Standard SMD process
- ✧ In line with the ROHS standard

Contents

Outline dimensions	3
Photoelectric properties	4
Limit service condition	4
Photoelectric parameter curve	5
Packaging.....	7
Reliability test.....	9
Recommended reflow temperature curve formula	9



Part No.: U3535C2VGB30

Outline dimensions: (Unit: mm, The tolerance $\pm 0.1\text{mm}$)

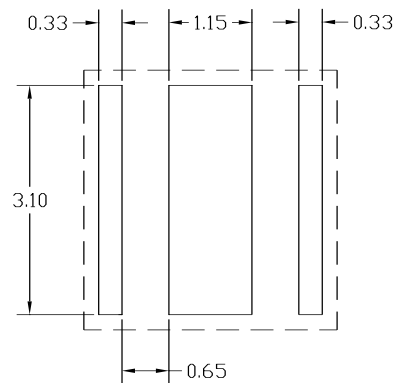
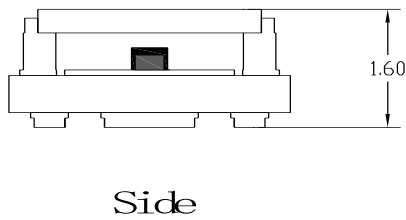
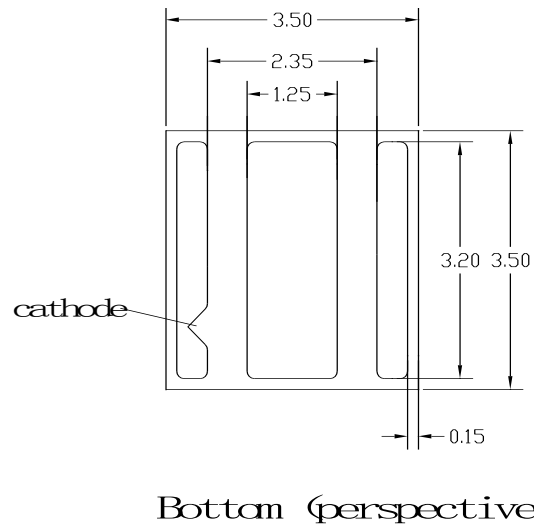
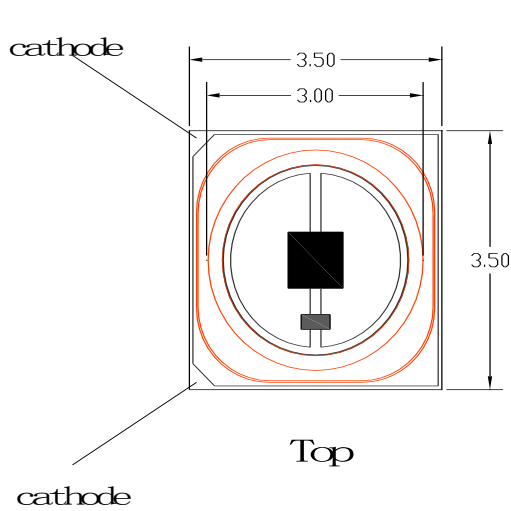

Recommended Mask Size

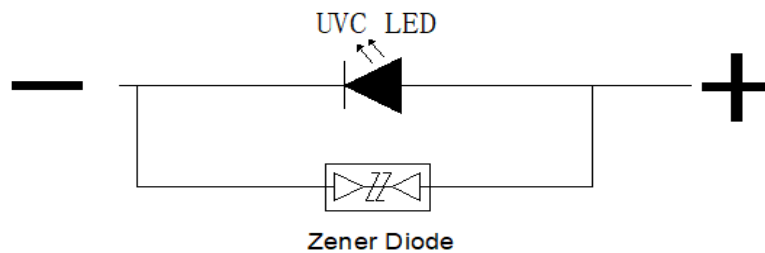



Part No.: U3535C2VGB30

Photoelectric properties (Ta = 25°C)

Parameter	Forward current	Symbol	Min.	Typ	Max	Unit
The peak wavelength	If=150mA	λ_p	270	275	280	nm
Output Radiated power		P_{opt}	--	20	--	mW
Forward Voltage		V_f	5	--	7.5	V
FWHM		$\Delta \lambda$	--	9	--	nm
Viewing Angle		$2\theta_{1/2}$	--	120	--	°
Thermal resistance (Tj-Tsp)		Rth	--	11	--	°C/W
Output Radiated power	If=300mA	P_{opt}	--	30	--	mW

Instructions: Tc =25°C; The tolerance of Forward voltage: $\pm 0.1V$; The tolerance of Radiation flux: $\pm 8\%$; The tolerance of peak wavelength : $\pm 3nm$ 。

Limit service condition

Parameter	Symbol	Unit	Range
Forward current	If	mA	≤ 300
Junction temperature	Tj	°C	≤ 90
Working temperature	Topr	°C	-30-60
The welding conditions	Tsol	-	260°C < 5seconds



Photoelectric parameter curve :

Fig.1 Relative Radiant Power VS Forward Current

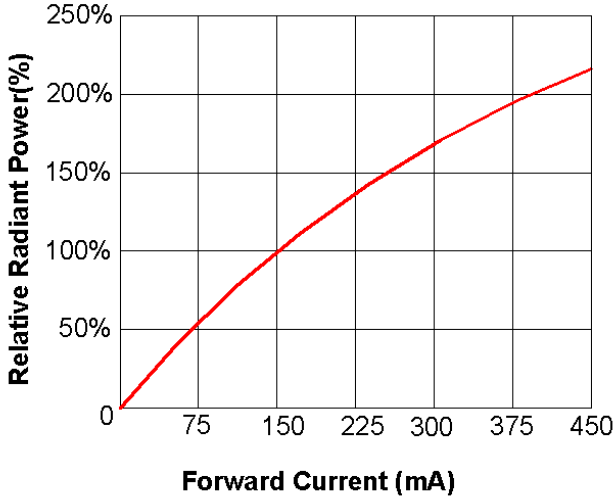

Fig.2 Forward Current VS Forward Voltage (Ta=25°C)

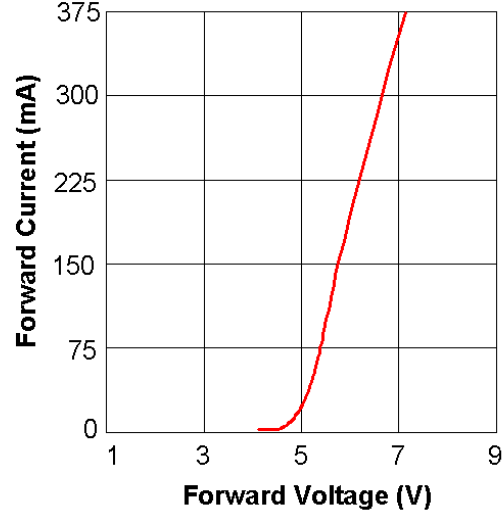

Fig.3 Forward Voltage VS Ambient Temperature

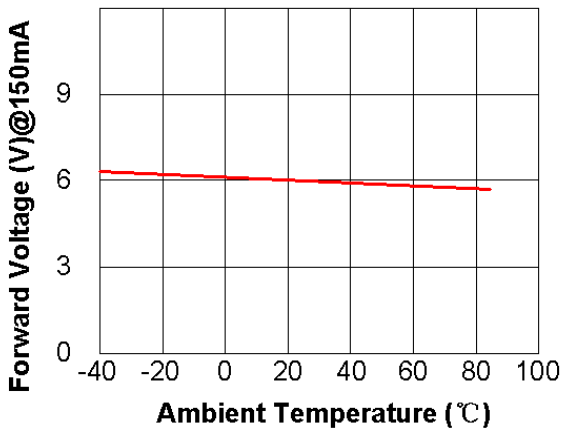

Fig.4 Relative Radiant Power VS Ambient Temperature

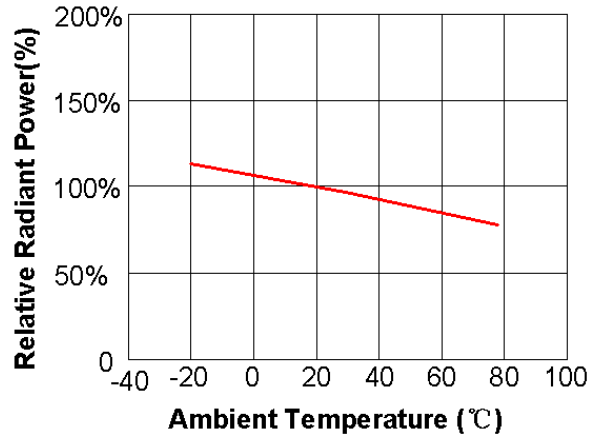



Fig.5 Peak Wavelength VS Forward Current

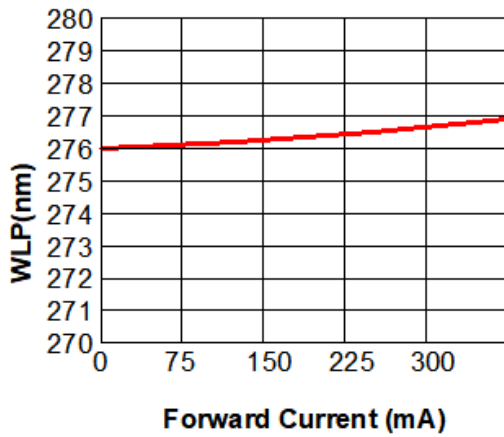

Fig.6 Forward Current VS Ambient Temperature

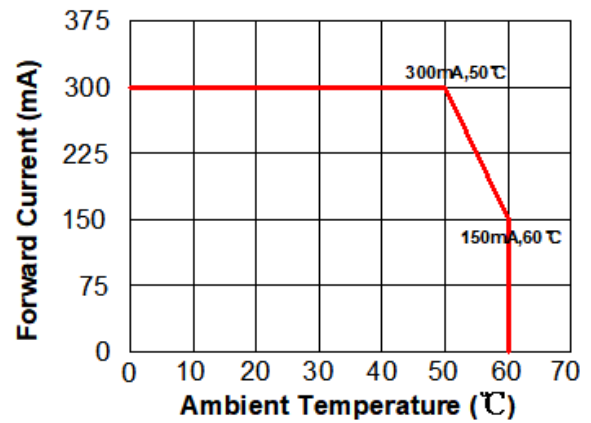

Fig.7 Relative Intensity VS WLP

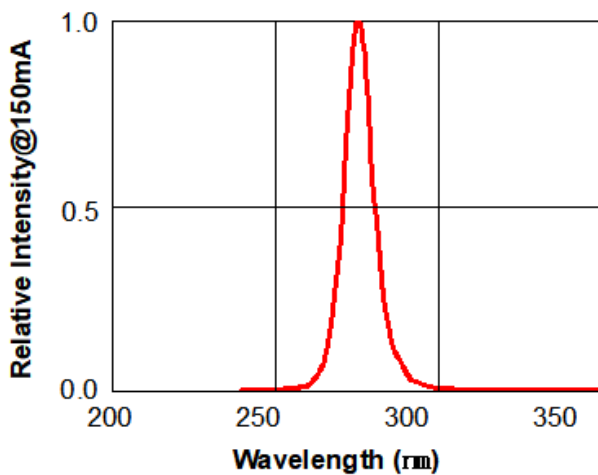
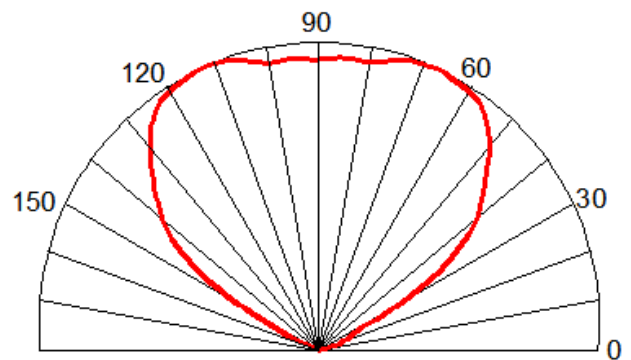

Fig.8 Radiation pattern@150mA





Part No.: U3535C2VGB30

Packing

(Unit: mm)

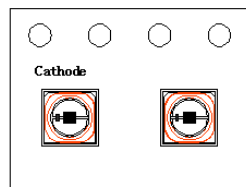
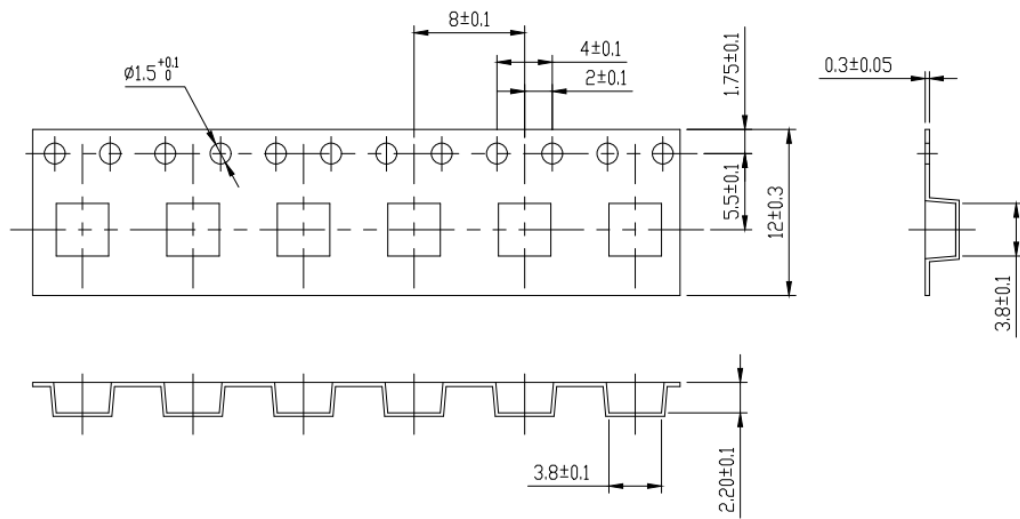

The End

Feed Direction

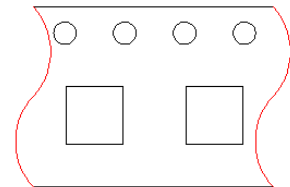
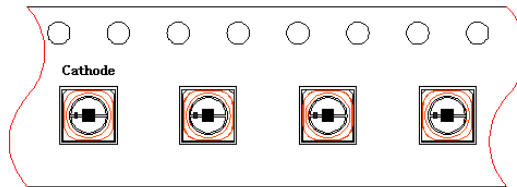
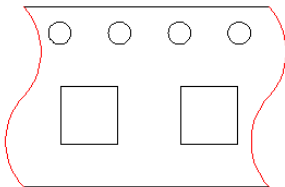

The blank space With 200mm

A roll of 1000PCS

The blank space With 400mm



Part No.: U3535C2VGB30

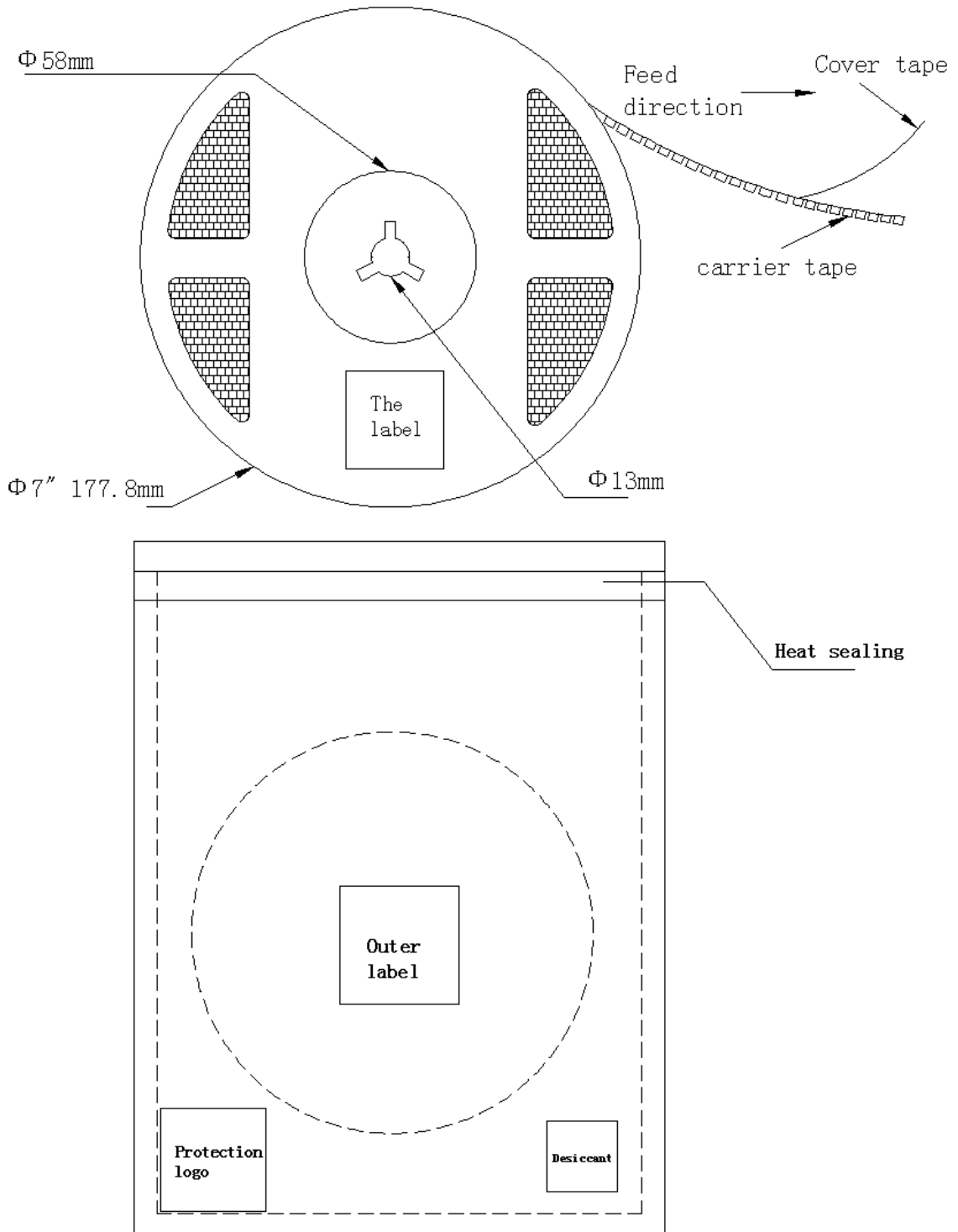

Notice:

Please refer to the label value for the actual number of products in each roll, but the total number will not exceed 1000.



Reliability test

Test	Test Conditions	Failure Criterion
Normal temperature life test	25°C, 150mA, 1000Hours	Forward voltage, $V_f > 110\%$
High temperature storage	100°C, 1000Hours	
Low temperature storage	-40°C, 1000Hours	Radiation power, $P_{opt} < 70\%$
Temperature cycle (100times)	-40°C (30mins) ~ +25°C (5mins) +100°C(30mins) ~ +25°C (5mins)	

Notice:

Test the device at room temperature

Recommend suitable temperature curve formula

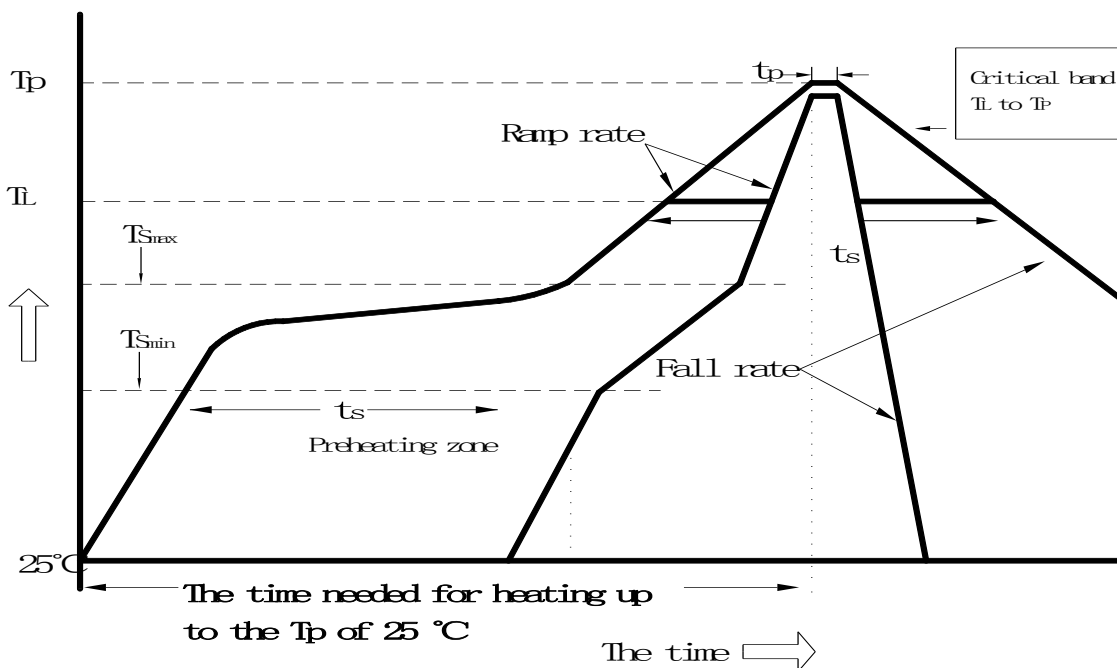



Part No.: U3535C2VGB30

Temperature curve characteristics	Lead-free solder
Ramp rate (TSmax to TP)	Max 3°C/S
Preheat: minimum temperature(Tsmin)	150°C
Prehea: maximum temperature(Tsmax)	200°C
Maintain a higher temperature: temperature (TL)	60-180 S
Liquid temperature (TL)	217°C
Maintain a higher temperature: time (TL)	60-150 S
Tp/temperature	260°C
Specify the time within 5°C of the actual peak temperature	20-40 S
The slope rate (Tp to TL)	Max 6°C/S
The time needed for heating up to theTp of 25 °C	Max 8 min