



Features

- Slim and Low profile (60mm)
- Fanless and conduction-cooled design
- Built-in active PFC function
- -30~+70°C working temperature
- Output voltage and constant current level programmable
- Protections: Short circuit / Overload / Over voltage / Over temperature
- Built-in remote ON-OFF control
- DC OK active signal
- Operating altitude up to 5000 meter (Note.7)
- LED indicator for power on
- Optional PMBus or CANBus protocol
- 5 years warranty

Certificates

- Safety: UL/EN62368-1
- EMC: EN55032 / 55024

Applications

- Industrial automation machinery
- Industrial control system
- Mechanical and electrical equipment
- Electronic instruments, equipment or apparatus
- Test and measurement instrument
- Laser related machine
- Charging related equipment
- Household appliances

Description

UHP-2500 series is a 2500W single-output slim type power supply with 60mm of low profile design. Adopting the full range 90~264VAC input, the entire series provides an output voltage line of 24V, 36V and 48V. In addition to the high efficiency up to 96%, that the whole series operates from -30°C ~ 70°C under air convection without fan. UHP-2500 has the complete protection functions and 2G anti-vibration capability; It is complied with the international safety regulations such as TUV EN62368-1, UL62368-1, and design refers to EN61558-1 and EN60335-1. UHP-2500 series serves as a high performance power supply solution for various industrial applications.

Model Encoding

UHP - 2500 - 24

- Communication protocol option
- Output voltage(24V/36V/48V)
- Rated wattage
- Series name

Type	Communication Protocol	Note
Blank	None	In Stock
PM	PMBus protocol	By request
CAN	CANBus protocol	By request

SPECIFICATION

MODEL	UHP-2500-24		UHP-2500-36	UHP-2500-48	
OUTPUT	DC VOLTAGE	24V	36V	48V	
	RATED CURRENT	104.2A	69.4A	52.1A	
	RATED POWER	2500.8W	2498.4W	2500.8W	
	RIPPLE & NOISE (max.) Note.2	300mVp-p	360mVp-p	480mVp-p	
	VOLTAGE ADJ. RANGE	By built-in potentiometer, SVR			
		24~28.8V	36~43.2V	48~57.6V	
	VOLTAGE TOLERANCE Note.3	±1.0%	±1.0%	±1.0%	
	LINE REGULATION	±0.5%	±0.5%	±0.5%	
	LOAD REGULATION	±1.0%	±1.0%	±0.5%	
SETUP, RISE TIME	1800ms, 60ms/230VAC at full load				
HOLD UP TIME (Typ.)	16ms/230VAC at 75% load	10ms/230VAC at full load			
INPUT	VOLTAGE RANGE Note.4	90 ~ 264VAC	250 ~ 370VDC		
	FREQUENCY RANGE	47 ~ 63Hz			
	POWER FACTOR (Typ.)	PF ≥ 0.95/230VAC at full load			
	EFFICIENCY (Typ.)	95%	95.5%	96%	
	AC CURRENT (Typ.)	14.3A/230VAC			
	INRUSH CURRENT (Typ.)	Cold start 60A/230VAC			
	LEAKAGE CURRENT	<0.75mA / 240VAC			
PROTECTION	OVERLOAD	105 ~ 115% rated output power Protection type : Constant current limiting, unit will shutdown after 5 sec. re-power on to recover.			
	OVER VOLTAGE	30 ~ 35V	45 ~ 51V	60 ~ 67V	
		Protection type : Shut down O/P voltage, re-power on to recover			
	OVER TEMPERATURE	Protection type : Shut down O/P voltage, recovers automatically after temperature goes down			
FUNCTION	OUTPUT VOLTAGE PROGRAMMABLE(PV) Note 5	Adjustment of output voltage is allowable to 50 ~ 120% of nominal output voltage Please refer to the Function Manual.			
	OUTPUT CURRENT PROGRAMMABLE(PC) Note 5	Adjustment of constant current level is allowable to 20 ~ 100% of rated current. Please refer to the Function Manual.			
	REMOTE ON/OFF CONTROL	Power ON : Short circuit Power OFF : Open circuit			
	AUXILIARY POWER	12V@0.4A tolerance±10%, ripple 150mVp-p			
	DC-OK SIGNAL	The TTL signal out, PSU turn on = 4.5 ~ 5.5V ; PSU turn off = -0.5 ~ 0.5V. Please refer to the Function Manual.			
ENVIRONMENT	WORKING TEMP.	-30 ~ +70°C (Refer to "Derating Curve")			
	WORKING HUMIDITY	20 ~ 90% RH non-condensing			
	STORAGE TEMP., HUMIDITY	-40 ~ +85°C, 10 ~ 95% RH non-condensing			
	TEMP. COEFFICIENT	±0.03%/°C (0 ~ 50°C)			
	VIBRATION	10 ~ 500Hz, 2G 10min./1cycle, 60min. each along X, Y, Z axes			
SAFETY & EMC (Note.6)	SAFETY STANDARDS	UL62368-1, TUV EN62368-1, EAC TP TC 004 approved; design refers to EN61558-1, EN60335-1 (by request)			
	WITHSTAND VOLTAGE	I/P-O/P: 3.75KVAC I/P-FG: 2KVAC O/P-FG: 1.25KVAC			
	ISOLATION RESISTANCE	I/P-O/P, I/P-FG, O/P-FG: 100M Ohms/500VDC/25°C / 70%RH			
	EMC EMISSION	Parameter	Standard	Test Level / Note	
		Conducted	EN55032 (CISPR32)	Class B	
		Radiated	EN55032 (CISPR32)	Class A	
		Harmonic Current	EN61000-3-2	Class A	
		Voltage Flicker	EN61000-3-3	-----	
	EMC IMMUNITY	EN55024, EN61000-6-2			
		Parameter	Standard	Test Level / Note	
		ESD	EN61000-4-2	Level 3, 8KV air ; Level 2, 4KV contact	
		Radiated	EN61000-4-3	Level 3	
		EFT / Burst	EN61000-4-4	Level 3	
		Surge	EN61000-6-2	2KV/Line-Line 4KV/Line-Earth	
		Conducted	EN61000-4-6	Level 3	
Magnetic Field		EN61000-4-8	Level 4		
Voltage Dips and Interruptions	EN61000-4-11	>95% dip 0.5 periods, 30% dip 25 periods, >95% interruptions 250 periods			
OTHERS	MTBF	166.12K hrs min. Telcordia SR-332 (Bellcore) ; 48.91K hrs min. MIL-HDBK-217F (25°C)			
	DIMENSION	310*140*60mm (L*W*H)			
	PACKING	3.5kg; 4pcs/15kg/1.76CUFT			
NOTE	1. All parameters NOT specially mentioned are measured at 230VAC input, rated load and 25°C of ambient temperature. 2. Ripple & noise are measured at 20MHz of bandwidth by using a 12" twisted pair-wire terminated with a 0.1uf & 47uf parallel capacitor. 3. Tolerance : includes set up tolerance, line regulation and load regulation. 4. Derating may be needed under low input voltages. Please check the derating curve for more details. 5. PV/PC functions when users do not use SVR. 6. The power supply is considered a component which will be installed into a final equipment. All the EMC tests are been executed by mounting the unit on a 1100mm*650mm metal plate with 1mm of thickness. The final equipment must be re-confirmed that it still meets EMC directives. For guidance on how to perform these EMC tests, please refer to "EMI testing of component power supplies." (as available on http://www.meanwell.com) 7. The ambient temperature derating of 3.5°C/1000m with fanless models and of 5°C/1000m with fan models for operating altitude higher than 2000m(6500ft).				

BLOCK DIAGRAM

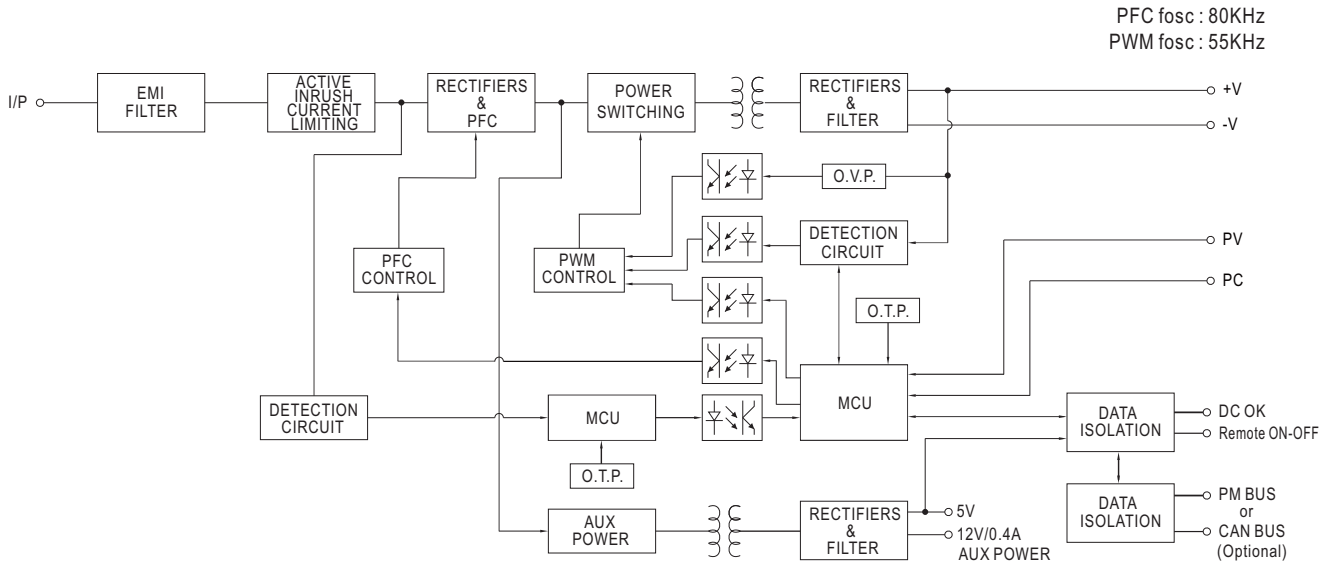

STATIC CHARACTERISTIC

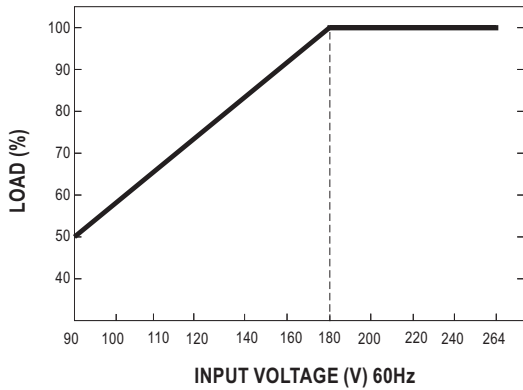

EFFICIENCY VS LOAD (48V MODEL)

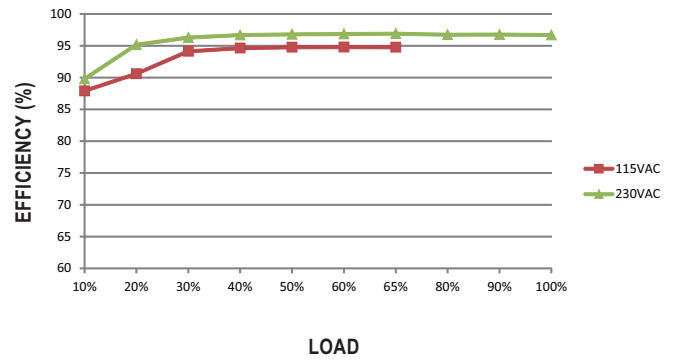

DERATING CURVE

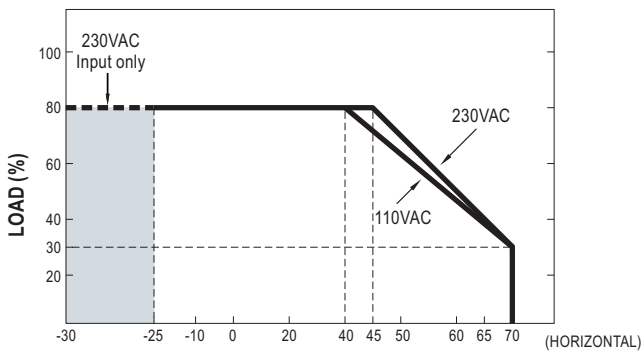

AMBIENT TEMPERATURE WITH ADDITIONAL ALUMINUM PLATE(°C)
(450x450x3mm)

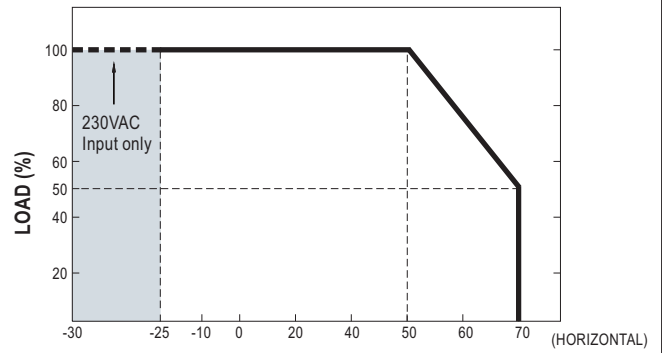

AMBIENT TEMPERATURE WITH 45CFM FAN(°C)

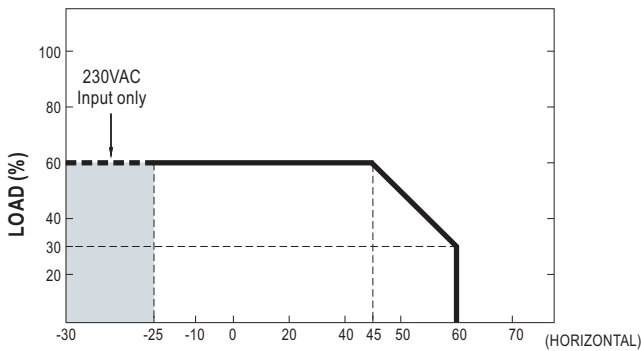

AMBIENT TEMPERATURE WITHOUT ALUMINUM PLATE(°C)

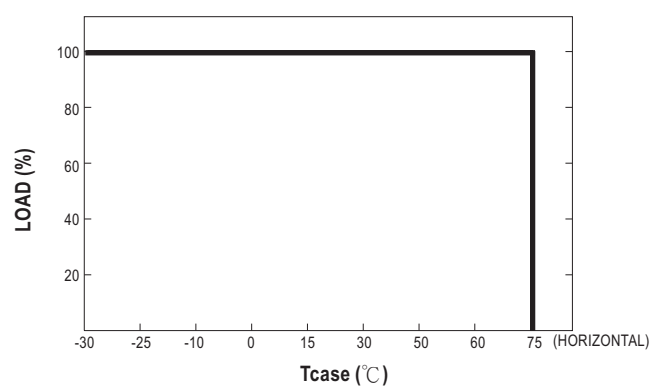

FUNCTION MANUAL

1. Output Voltage Programming (or, PV / remote voltage programming / remote adjust / margin programming / dynamic voltage trim)

※ In addition to the adjustment via the built-in potentiometer, the output voltage can be trimmed by applying EXTERNAL VOLTAGE.

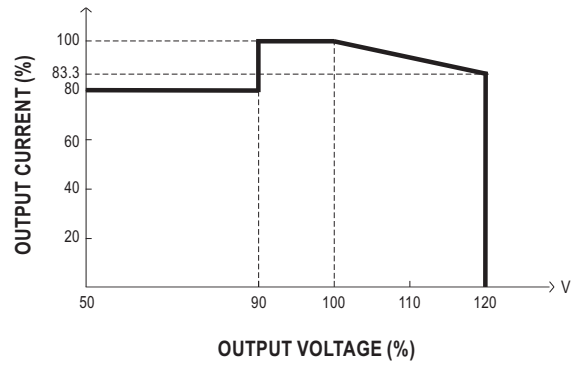
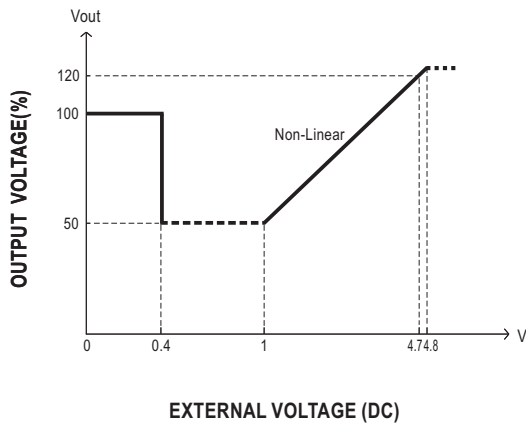
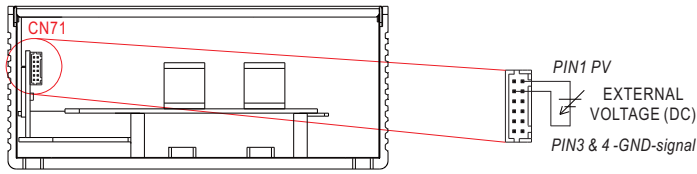

◎ The rated current should change with the Output Voltage Programming accordingly.

2. Constant Current Programming (or, PC / remote current programming / dynamic current trim)

※ The output current can be trimmed to 20~100% of the rated current by applying EXTERNAL VOLTAGE.

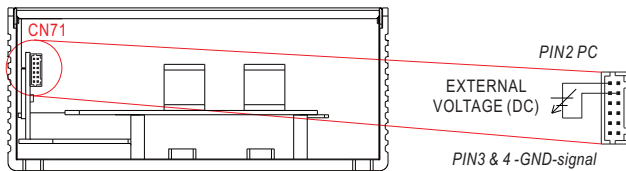

※ Covered by over temperature protection, auto de-rating function works under operation either in PC mode or under control by communication protocol.

T₁(Typ.): Maximum ambient temperature of full load.

T₂(Typ.): T₁+5°C.

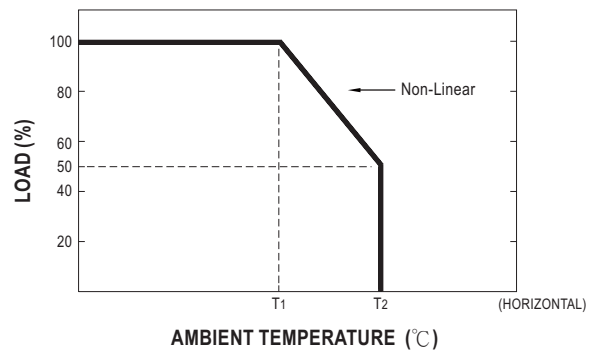
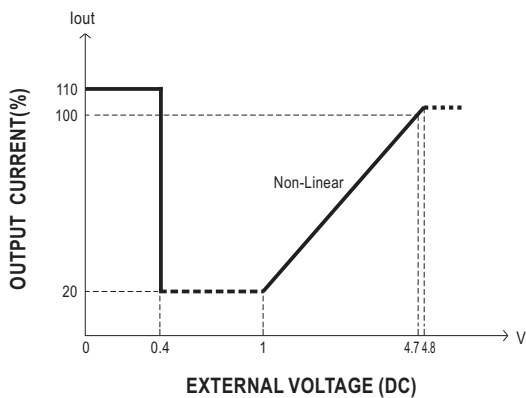

3. Remote ON-OFF Control

The power supply can be turned ON/OFF individually or along with other units in parallel by using the "Remote ON-OFF" function.

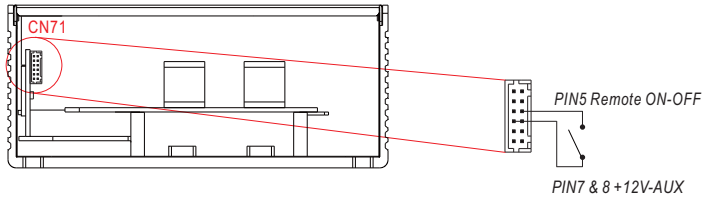

Remote ON-OFF	Power Supply Status
Short circuit	ON
Open circuit	OFF

4. DC-OK Signal

DC-OK signal is a TTL level signal. The maximum sourcing current is 10mA.

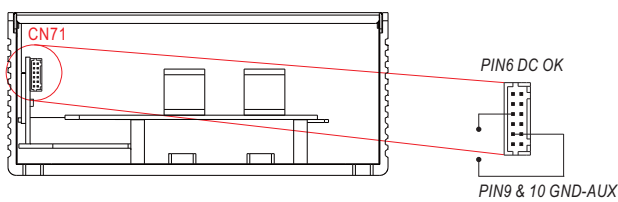

DC-OK signal	Power Supply Status
"High" >4.5~5.5V	ON
"Low" <-0.5~0.5V	OFF

5. PMBus Communication Interface

UHP-2500 supports PMBus Rev. 1.2 with maximum 100KHz bus speed, allowing information reading, status monitoring, output trimming, etc. For details, please refer to the Function Manual.

MECHANICAL SPECIFICATION

Case No.276A

Unit:mm

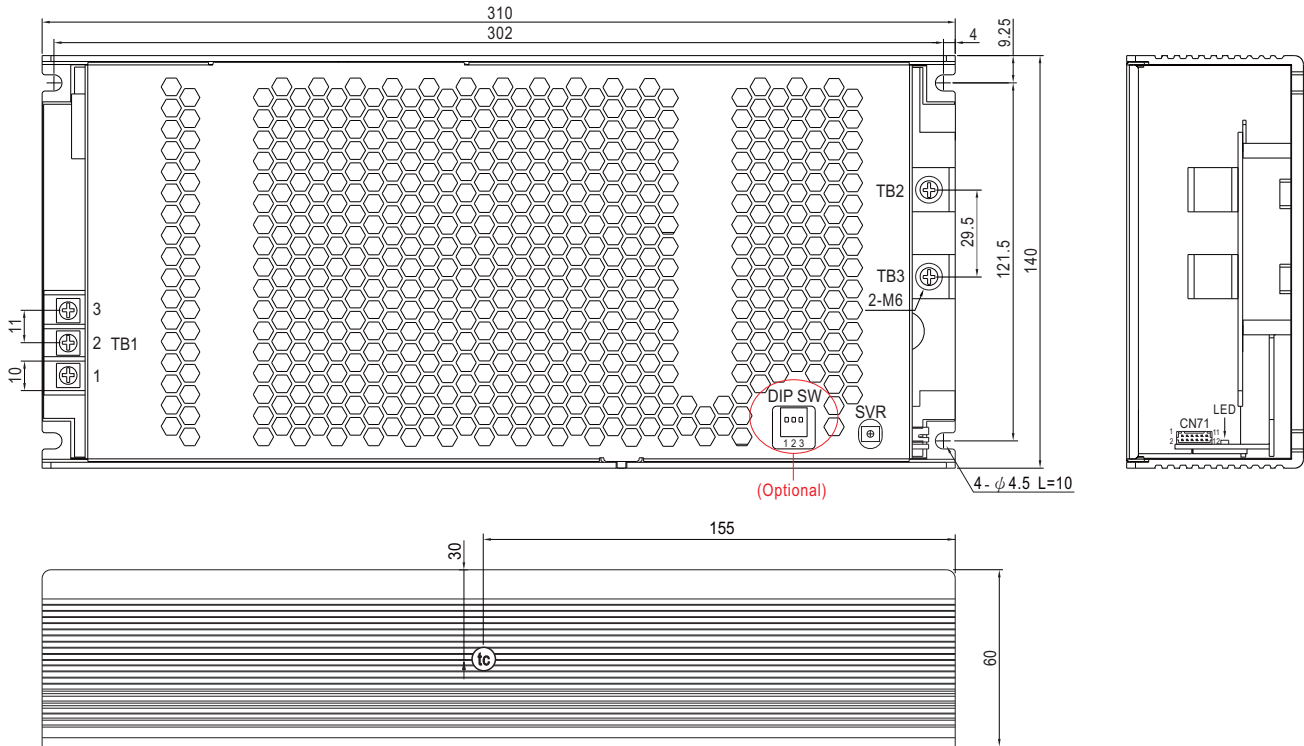

• (tc) : Max. Case Temperature

AC Input Terminal(TB1) Pin NO. Assignment

Pin No.	Assignment	Terminal	Max mounting torque
1	AC/L	DECA T36	13Kgf-cm
2	AC/N		
3	⊕		

DC Output Terminal(TB2,TB3) Pin NO. Assignment

Pin No.	Assignment	Terminal	Max mounting torque
TB2	+V	(MW)	8Kgf-cm
TB3	-V	HS147	

※DIP SW(Optional):

Pin No.	Function	Description
1	A0	PMBus / CANBus interface address switch.
2	A1	
3	A2	

※Control Pin No. Assignment(CN71) : HRS DF11-12DP-2DS or equivalent



Mating Housing	HRS DF11-12DS or equivalent
Terminal	HRS DF11-**SC or equivalent

Pin No.	Function	Description
1	PV	Connection for output voltage programming.(Note1)
2	PC	Connection for constant current level programming.(Note.1)
3,4	GND (Signal)	Negative output voltage signal.
5	Remote ON-OFF	The unit can turn the output ON/OFF by dry contact between Remote ON/OFF and 12-AUX.(Note.2) Short (10.8 ~ 13.2V) : Power ON ; Open(-0.5 ~ 0.5V) : Power OFF ; The maximum input voltage is 13.2V
6	DC-OK	Low (-0.5 ~ 0.5V) : When the Vout ≤ 77% ± 6%. High (4.5 ~ 5.5V) : When Vout ≥ 80% ± 6%. The maximum sourcing current is 10mA and only for output.(Note.2)
7,8	+12V-AUX	Auxiliary voltage output, 10.8~13.2V, referenced to GND-AUX (pin3 & 4). The maximum load current is 0.4A. This output is not controlled by "Remote ON-OFF".
9,10	GND-AUX	Auxiliary voltage output GND. The signal return is isolated from the output terminals (+V & -V).
11	SDA	For PMBus model: Serial Data used in the PMBus interface. (Note.2)
	CANH	For CANBus model: Data line used in CANBus interface. (Note.2)
12	SCL	For PMBus model: Serial Clock used in the PMBus interface. (Note.2)
	CANL	For CANBus model: Data line used in CANBus interface. (Note.2)

Note1: Non-isolated signal, referenced to [GND(signal)].

Note2: Isolated signal, referenced to GND-AUX.

Operate with additional aluminum plate and fan

In order to meet the "Derating Curve" and the "Static Characteristics", UHP-2500 series can be installed onto an aluminum plate (or the cabinet of the same size) on the bottom or apply forced air cooled solution. The size of the suggested aluminum plate and configuration of fan are shown as below. And for optimizing thermal performance, the aluminum plate must have an even and smooth surface (or coated with thermal grease), and UHP-2500 series must be firmly mounted at the center of the aluminum plate.

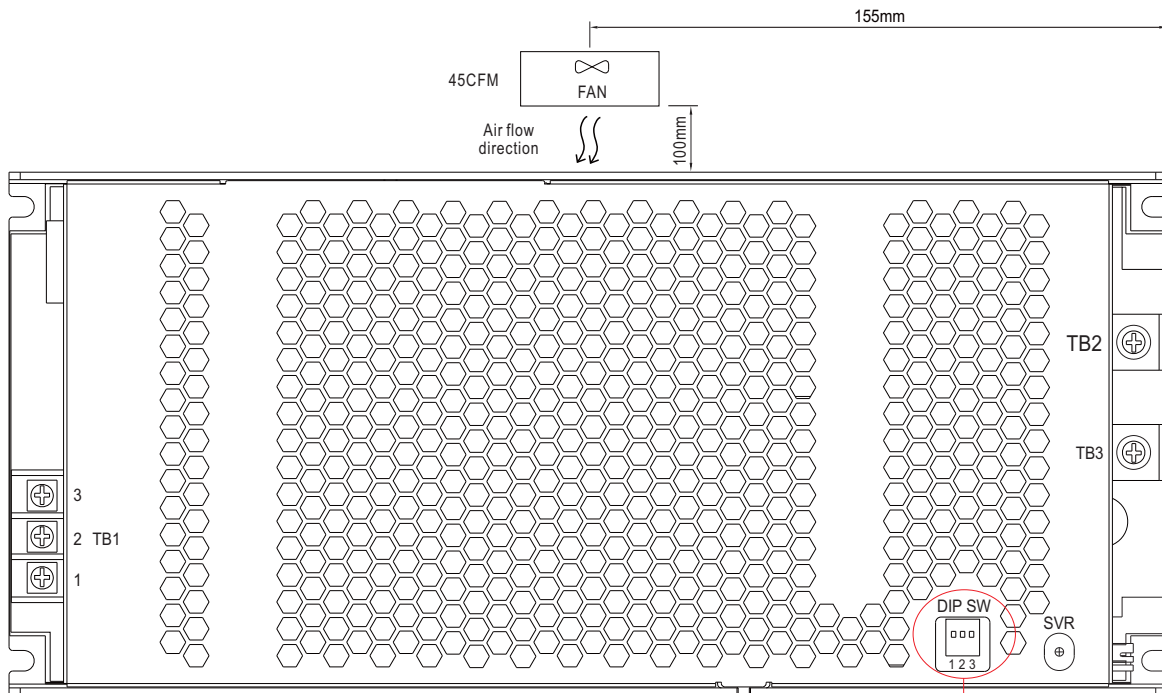
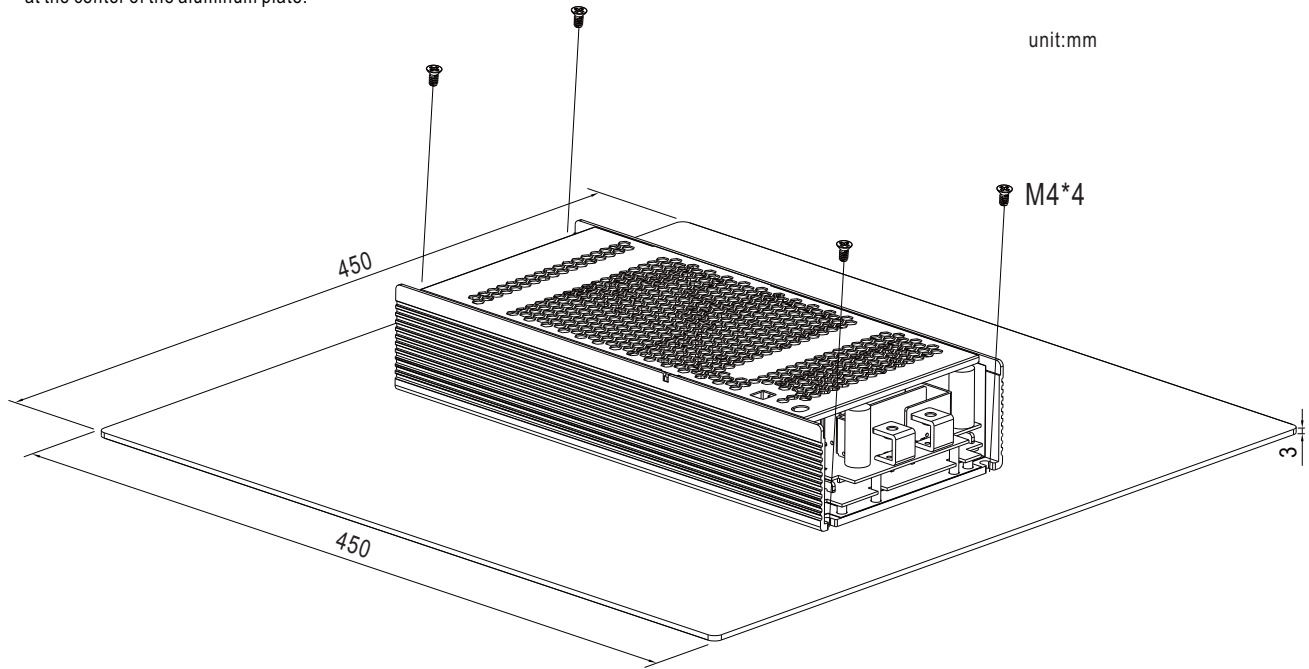

(Optional)