

SPECIFICATION		
1	Model No.	PIEZO20T-3.6A1-EST
2	Fr(KHz)	3.6±0.5
3	Zr(Ω)	300
4	C(nF)	20nF±30%
5	Dimension(mm) D	20
6	Dimension(mm) d	14
7	Dimension(mm) T	0.22
8	Dimension(mm) t	0.1
9	Metal	Brass
10	Rohs	Yes

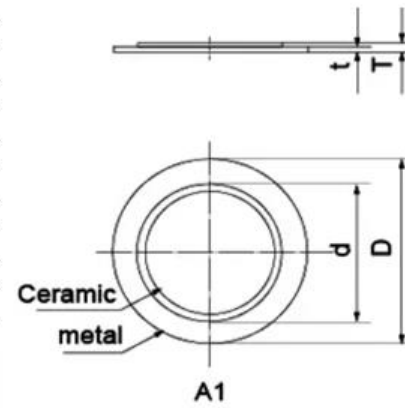

REVISION HISTORY			
LTR	DESCRIPTION	DATE	APPROVED
-	RELEASED FROM ENGINEERING	9/23/2003	
A			
C			
B			

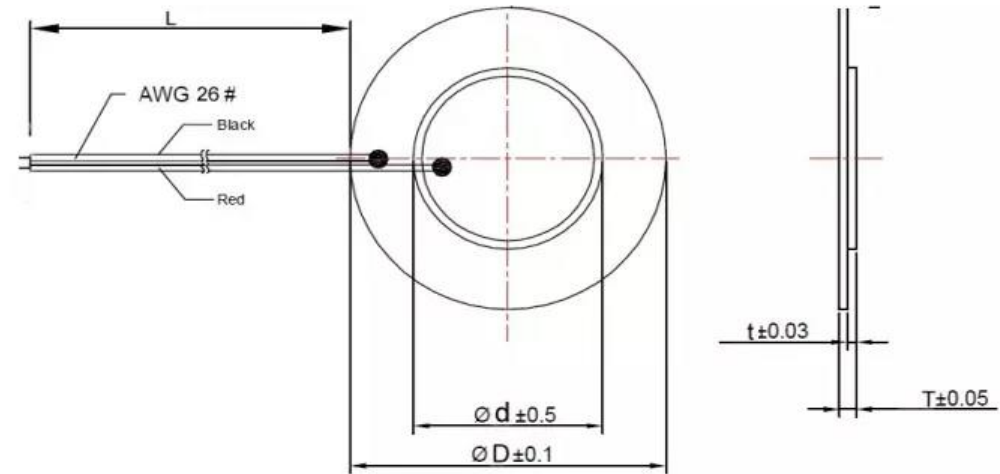
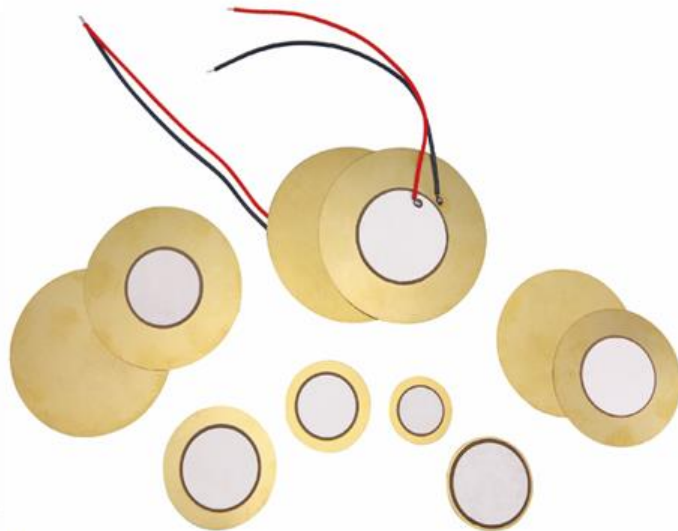

NOTES:

- 1.ALL DIMENSIONS ARE IN MILLIMETERS
- 2.SPECIFICATIONS SUBJECT TO CHANGE WITHOUT NOTICE