



# PC35H13 V0

## Product Specification

## Approval Sheet

PC35H13 V0  
Product Specification

RoHS

<b>Product</b>	White SMD LED
<b>Part Number</b>	PC35H13 V0
<b>Issue Date</b>	2017/08/02



### ■ Feature

- ✓ White SMD LED (L x W x H) of 3.5x 2.8 x 0.65 mm
- ✓ ASNI Ellipse binning
- ✓ Dice Technology : InGaN
- ✓ Qualified according to JEDEC moisture sensitivity Level 3
- ✓ Environmental friendly ; RoHS compliance
- ✓ Packing : 2000 & 4000 pcs/reel

### ■ Applications

- ✓ Portable flashlight
- ✓ Reading lights
- ✓ Security / garden lighting
- ✓ General lighting
- ✓ Indoor and outdoor commercial lighting

## Outline Dimension

PC35H13 V0  
Product Specification

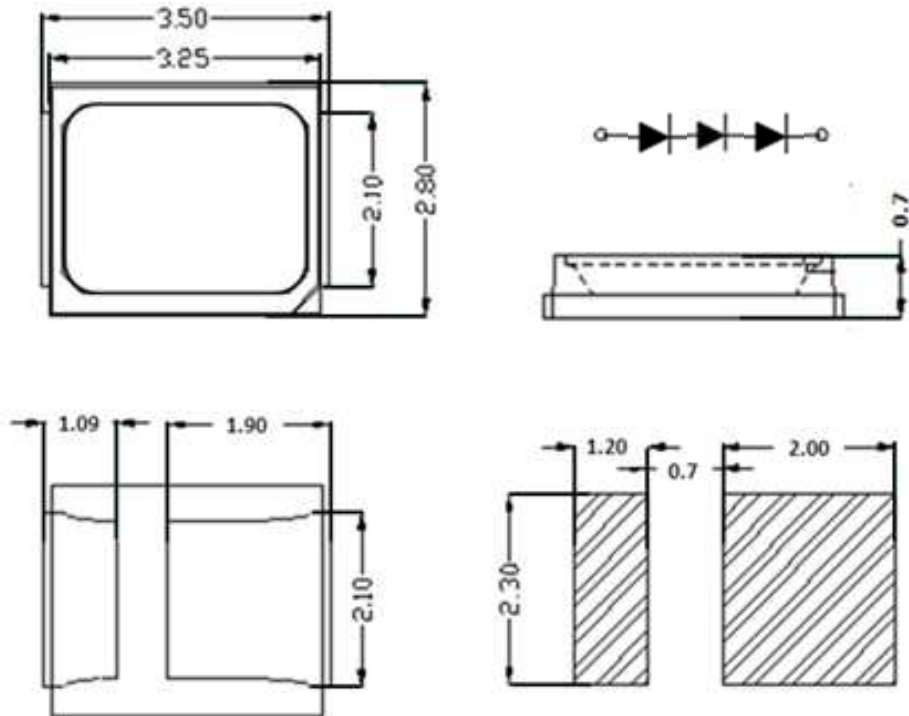

1. Unit :mm
2. Tolerance :  $\pm 0.1\text{mm}$

Performance

PC35H13 V0  
 Product Specification

■ **Electro-Optical Characteristics (Ta=25°C)**

Parameter	Symbol	Condition	Min.	Typ.	Max.	Unit
Forward Voltage <sup>(1)</sup>	V <sub>F</sub>	I <sub>F</sub> = 100 mA	9.0	-	9.9	V
Color Rendering Index <sup>(2)</sup>	R <sub>a</sub>		80	-	-	-
View Angle	θ		-	120	-	deg
Thermal Resistance <sup>(3)</sup>	R <sub>th</sub>		-	25	-	°C/W

(1) The Forward Voltage tolerance is ±0.1V

(2) The Color Rendering Index tolerance is ±2

(3) Thermal resistance is calculated from junction to solder

■ **Luminous Flux (Ta=25°C)**

CCT	Condition	Rank
2600K~3700K	I <sub>F</sub> = 100 mA	VT,UA
3700K~7000K		UB,VV

\* The luminous flux tolerance is ± 7%

■ **Absolute Maximum Ratings**

Parameter	Symbol	value	Unit
DC Forward Current <sup>(1)</sup>	I <sub>F</sub>	120	mA
Power Dissipation	P <sub>D</sub>	0.96	W
Pulse Forward Current <sup>(2)</sup>	I <sub>FP</sub>	150	mA
Storage Temperature	T <sub>stg</sub>	-40 ~ 100	°C
Operating Temperature	T <sub>opr</sub>	-40 ~ 85	°C
Junction Temperature	T <sub>J</sub>	125	°C
Assembly Temperature		260 (5 sec)	°C

(1) Proper current rating must be observed to maintain junction temperature below maximum at all time

(2) IFP Condition: Duty 1/10, Pulse within 10msec

**P C 3 5 H 1 3 0 - A 2 7 1 Y 0 V T V U G I - 0 0 0**

1	2	3	4	5	6	7	8	9	10	11	12	13	14	15	16	17	18	19	20	21	22	23
---	---	---	---	---	---	---	---	---	----	----	----	----	----	----	----	----	----	----	----	----	----	----

Item	Pos.	Code	Spec		
Model Name	1-8	PC35H130	PC35H13 V0		
CIE Center Point	9	A	ANSI 1931 on B.B.L		
CCT	10,11	27	27 = 2700K		
		30	30 = 3000K		
		35	35 = 3500K		
		40	40 = 4000K		
		50	50 = 5000K		
		57	57 = 5700K		
		65	65 = 6500K		
R9	12	1	R9 > 0		
CIE Bin Group <sup>(1)</sup>	13,14	Y0 Z0	275 275,27F,27G,27H,27I		
IV Bin Group	15,16, 17,18	VTVU VTVV	Bin code : VT,VU Bin code : VT,VU,VV,		
Vf Bin Group	19,20	GI	Bin code : G,H,I		
Kitting Rules	CIE <sup>(1)</sup>	21	0 1 <sup>(2)</sup> 2 <sup>(2)</sup>	No requirements. 275+275 275+275,27F+27H,27G+27I	
		IV	22	0	No requirements.
		Vf	23	0	No requirements.

- (1) The first two digits 27 means CCT in 2700K, can be replaced to 30, 35, 40, 50, 57, 65 for different CCT requirements.
- (2) Only under an agreement between customer and Lextar Electronics, kitting rules besides "0" can be supplied.

■ **Standard Ordering Code:**

CCT	Ordering Code <sup>(1)</sup>	CIE Bin Group	IV Bin Group	Vf Bin Group
2700K	PC35H130-A271Y0VTVUGI-000	Y0	VT,VU	G,H,I
	PC35H130-A271Z0VTVUGI-000	Z0		
3000K	PC35H130-A301Y0VTVUGI-000	Y0	VT,VU	G,H,I
	PC35H130-A301Z0VTVUGI-000	Z0		
3500K	PC35H130-A351Y0VTVUGI-000	Y0	VT,VU	G,H,I
	PC35H130-A351Z0VTVUGI-000	Z0		
4000K	PC35H130-A401Y0VTVVGI-000	Y0	VT,VU,VV,	G,H,I
	PC35H130-A401Z0VTVVGI-000	Z0		
5000K	PC35H130-A501Y0VTVVGI-000	Y0	VT,VU,VV,	G,H,I
	PC35H130-A501Z0VTVVGI-000	Z0		
5700K	PC35H130-A571Y0VTVVGI-000	Y0	VT,VU,VV,	G,H,I
	PC35H130-A571Z0VTVVGI-000	Z0		
6500K	PC35H130-A651Y0VTVVGI-000	Y0	VT,VU,VV,	G,H,I
	PC35H130-A651Z0VTVVGI-000	Z0		

(1) Only under an agreement between customer and Lextar Electronics, Ordering codes not in “Standard Ordering Code Definitions” can be supplied.

## Binning- ANSI Ellipse Binning

PC35H13 V0

Product Specification

### Chromaticity Coordinates

PC35H13 is hot color targeted so that at 85°C, the color is within ANSI while typical bin structured at 85°C. In application conditions, the LED temperature rises and at 85°C the typical color bins will be as shown.

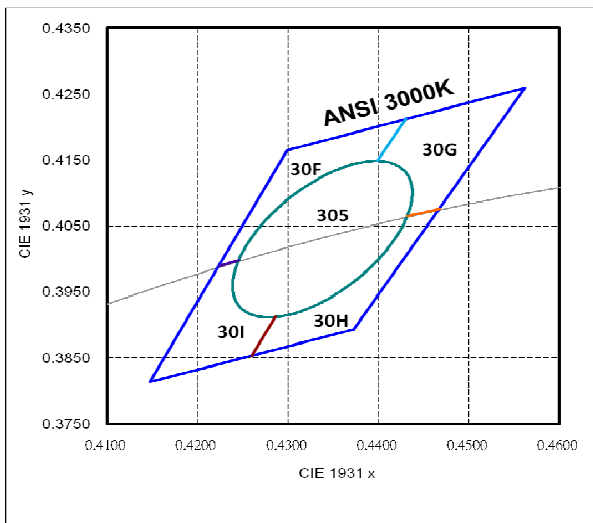
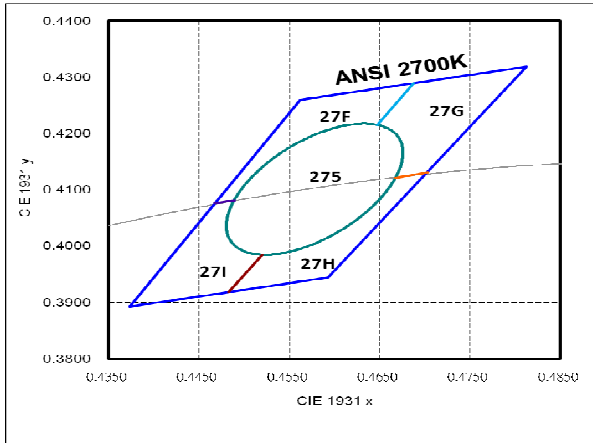

CCT	Steps	Target Center Point (CIE <sub>x</sub> , CIE <sub>y</sub> )		A(Major Axis)	B(Minor Axis)	Ellipse Rotation Angle
2700K	5	0.4578	0.4101	0.0135	0.007	53.7
3000K	5	0.4338	0.4030	0.0139	0.0068	53.22

	CIE-X	CIE-Y		CIE-X	CIE-Y
2700K	0.4813	0.4319	3000K	0.4562	0.426
	0.4562	0.4260		0.4299	0.4165
	0.4373	0.3893		0.4147	0.3814
	0.4593	0.3944		0.4373	0.3893

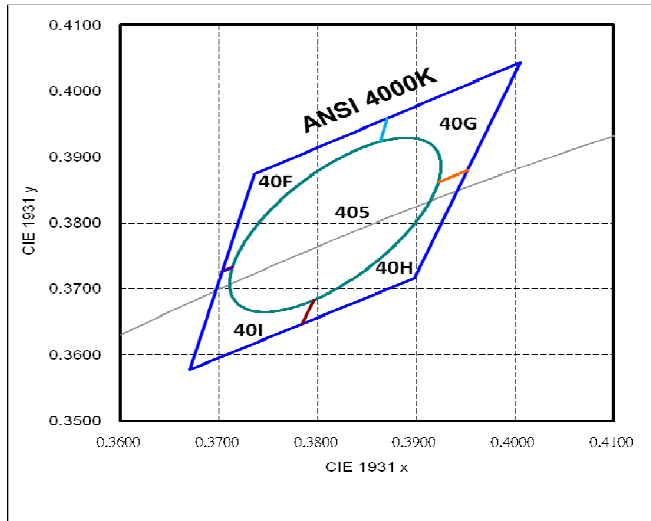
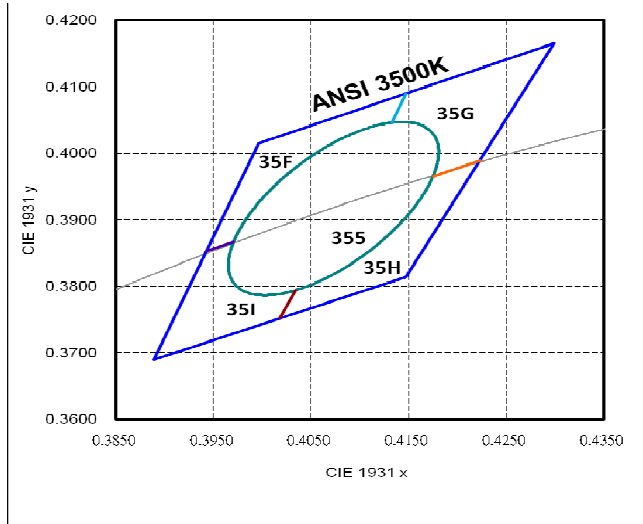

CCT	Steps	Target Center Point (CIE <sub>x</sub> ,CIE <sub>y</sub> )		A(Major Axis)	B(Minor Axis)	Ellipse Rotation Angle
3500K	5	0.4073	0.3917	0.01545	0.0069	53.22
4000K	5	0.3818	0.3797	0.01565	0.0067	53.72

	CIE-X	CIE-Y		CIE-X	CIE-Y
3500K	0.4299	0.4165	4000K	0.4006	0.4044
	0.3996	0.4015		0.3736	0.3874
	0.3889	0.3690		0.3670	0.3578
	0.4147	0.3814		0.3898	0.3716



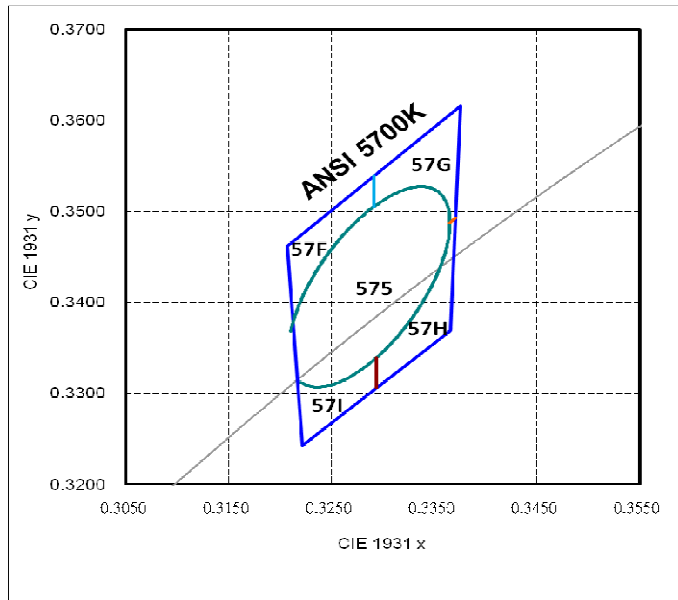
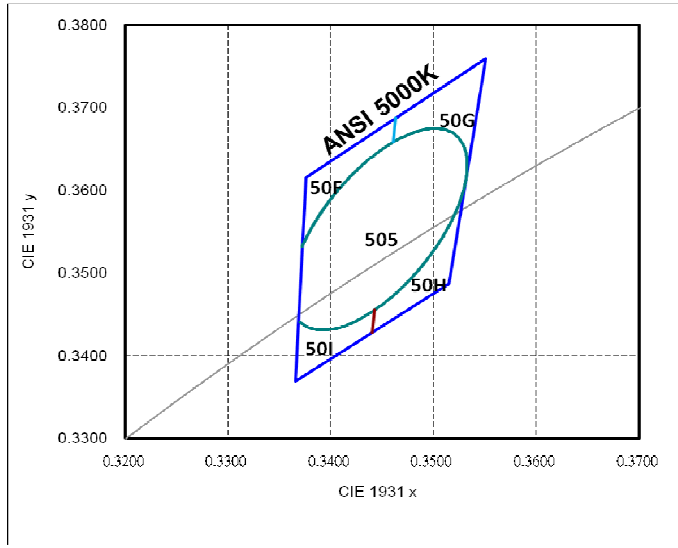

CCT	Steps	Target Center Point (CIE <sub>x</sub> ,CIE <sub>y</sub> )		A(Major Axis)	B(Minor Axis)	Ellipse Rotation Angle
5000K	5	0.3447	0.3553	0.0137	0.0059	59.62
5700K	5	0.3287	0.3417	0.0124	0.0053	59.09

	CIE-X	CIE-Y		CIE-X	CIE-Y
5000K	0.3551	0.3760	5700K	0.3376	0.3616
	0.3376	0.3616		0.3207	0.3462
	0.3366	0.3369		0.3222	0.3243
	0.3515	0.3487		0.3366	0.3369

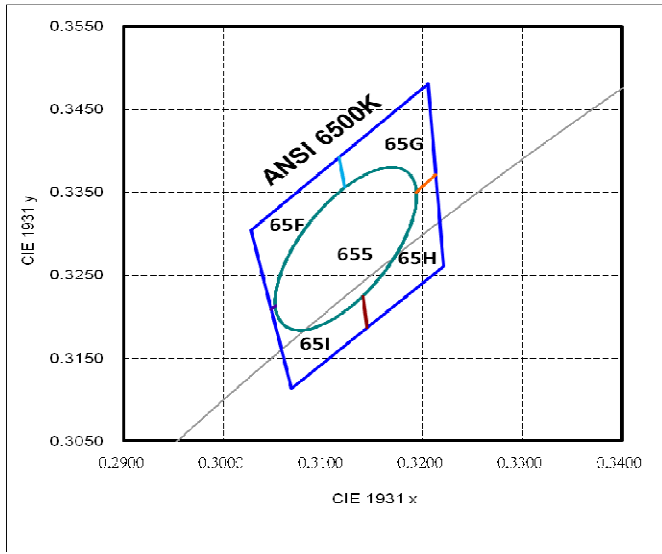

CCT	Steps	Target Center Point (CIE <sub>x</sub> ,CIE <sub>y</sub> )		A(Major Axis)	B(Minor Axis)	Ellipse Rotation Angle
<b>6500K</b>	<b>5</b>	<b>0.3123</b>	<b>0.3282</b>	<b>0.01115</b>	<b>0.00475</b>	<b>58.57</b>

	CIE-X	CIE-Y
6500K	0.3205	0.3481
	0.3028	0.3304
	0.3068	0.3113
	0.3221	0.3261

Note:

- (1) Correlated color temperature is derived from the CIE 1931 chromaticity diagram
- (2) CIE measurement tolerance is  $\pm 0.005$

■ **Bin code definition**

$V_F$ Rank	Luminous Flux Rank	CIE Rank
G	VT	655

$V_F$ Rank	Condition	Min.	Max.
G	$I_F = 100 \text{ mA}$	9.0	9.3
H		9.3	9.6
I		9.6	9.9
Luminous Flux Rank	Condition	Min.	Max.
VT	$I_F = 100 \text{ mA}$	105	110
UA		110	115
UB		115	120
VV		120	130

Note:

- (3) The luminous flux tolerance is  $\pm 7\%$
- (4) The Forward Voltage tolerance is  $\pm 0.1\text{V}$

## Characteristics

PC35H13 V0  
Product Specification

### Spectrum

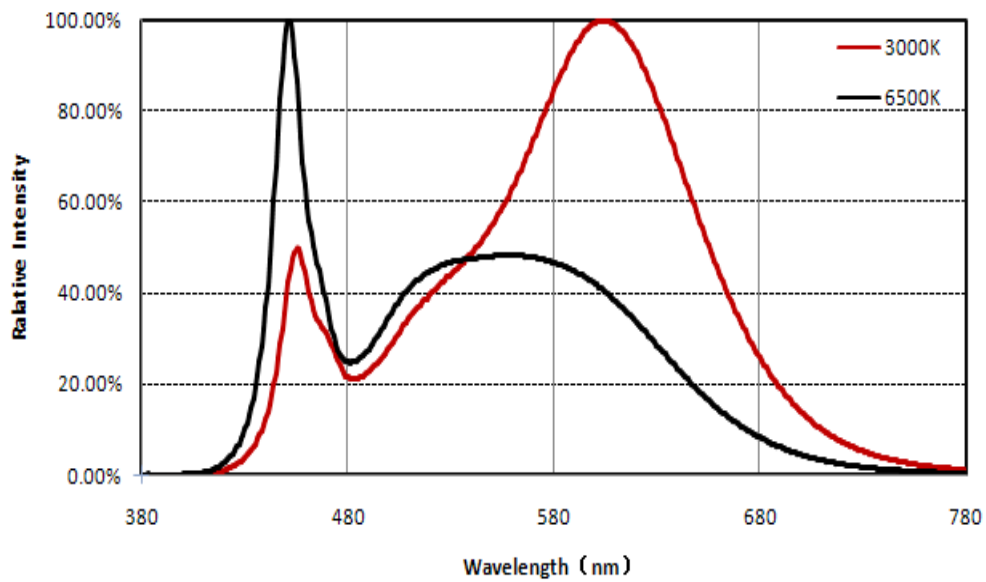

### Radiation Pattern

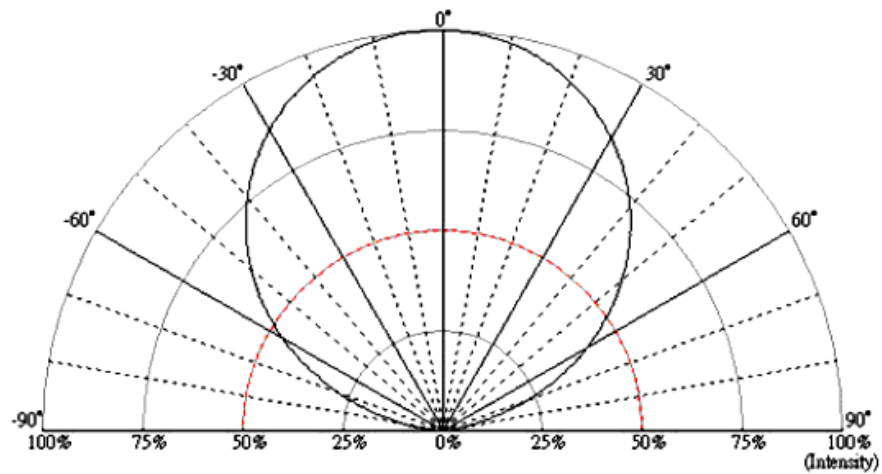

■ **Forward Voltage vs. Forward Current**

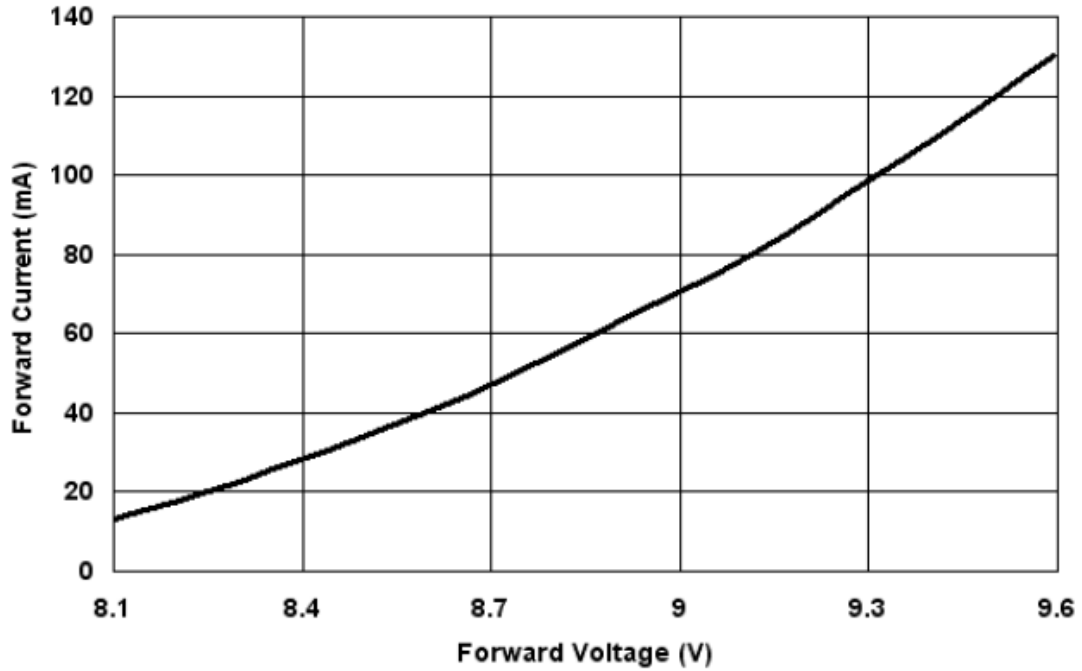

■ **Forward Current vs. Relative Luminosity**

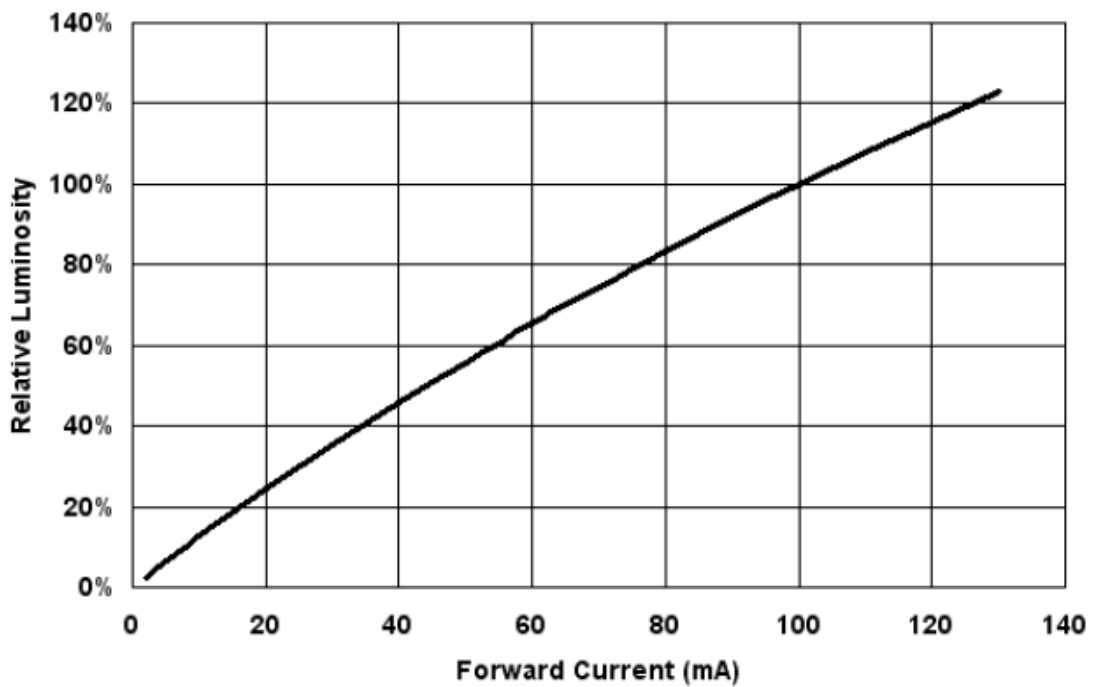

■ **Forward Current vs. Chromaticity Coordinate**

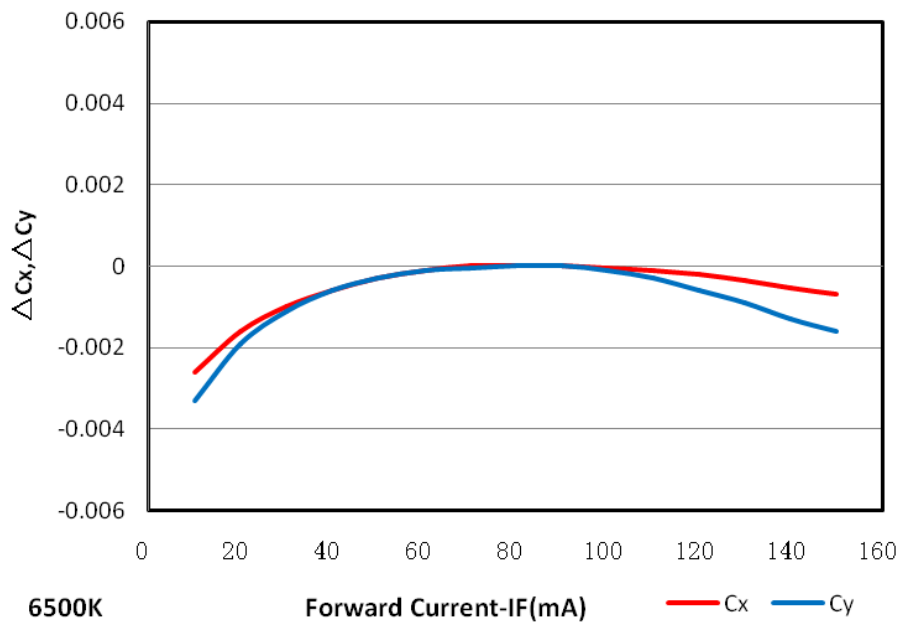
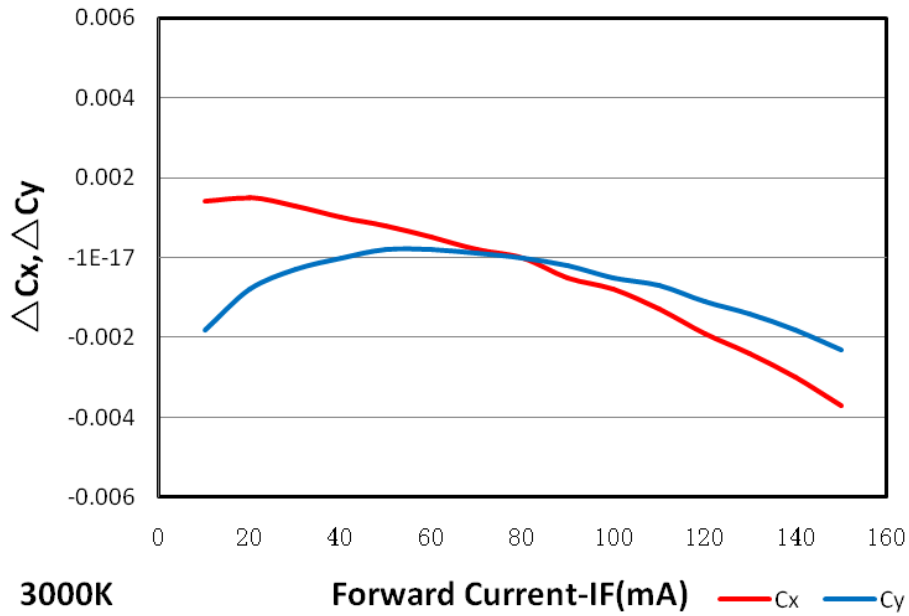

■ **Relative Luminous Intensity vs. Ambient Temperature**

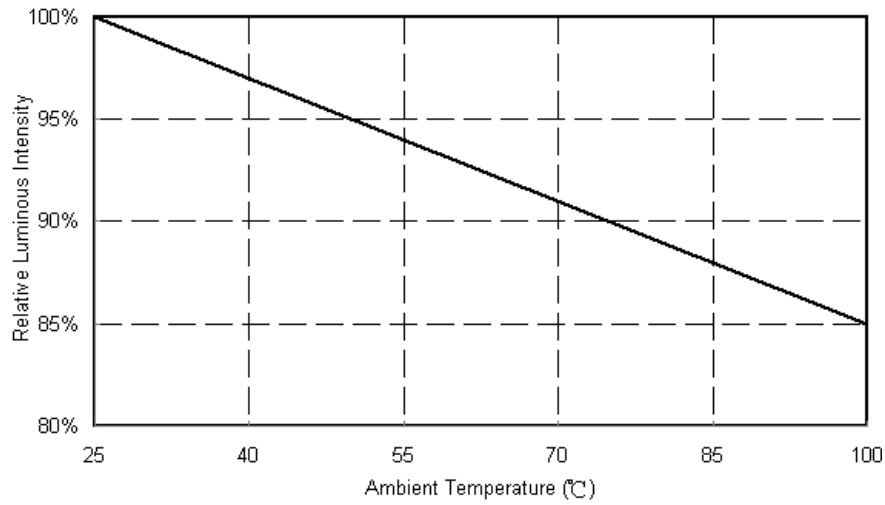

■ **Chromaticity vs. Ambient Temperature**

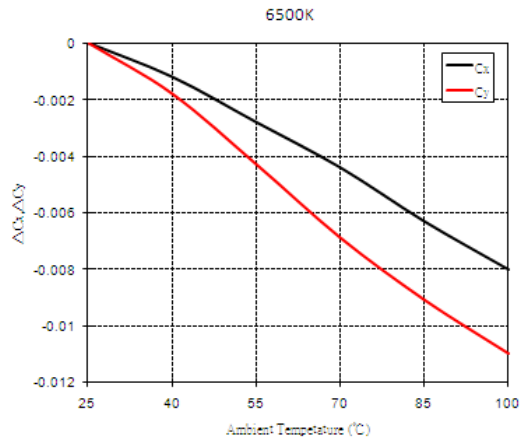
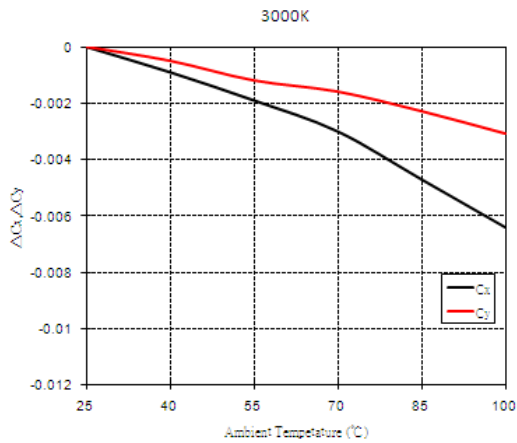

■ **Relative VF vs. Ambient Temperature**

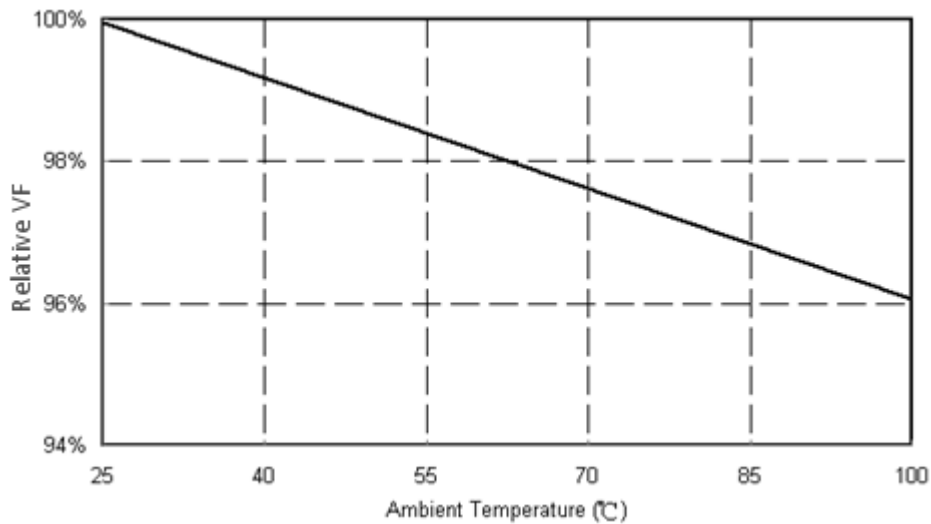

## Reliability

PC35H13 V0  
 Product Specification

### Reliability test

Item	Condition	Time/Cycle
Steady State Operating Life of Low Temperature -40°C	-40°C Operating	1000 Hrs
Steady State Operating Life of High Temperature 60°C	60°C Operating	1000 Hrs
Steady State Operating Life of High Temperature Ts105°C	Ts 105 °C Operating	1000 Hrs
Low temperature storage -40°C	-40°C Storage	1000 Hrs
High temperature storage 100°C	100°C Storage	1000 Hrs
Steady State Operating Life of High Humidity Heat 60°C/90%	60°C/90% Operating	1000 Hrs
Resistance to soldering heat on PCB (JEDEC MSL3)	pre-store @60°C, 60%RH for 52hrs T <sub>sld</sub> max.=260°C 10sec	1 cycle 3 Times
Thermal shock	-40°C/20minr ~5minr ~ 100°C/20min	100 Cycles

### Judgment Criteria

Item	Symbol	Test Condition	Judgment Criteria
Forward Voltage	V <sub>f</sub>	100mA	ΔV <sub>f</sub> < 10 %
Luminous Flux	I <sub>v</sub>	100mA	ΔI <sub>v</sub> < 30 %



**Packing**

PC35H13 V0  
Product Specification

**Label**

 QTY :  Bin code :  Vendor lot : M/N :	<b>Lextar</b>
---	---------------

**Carrier Taping**

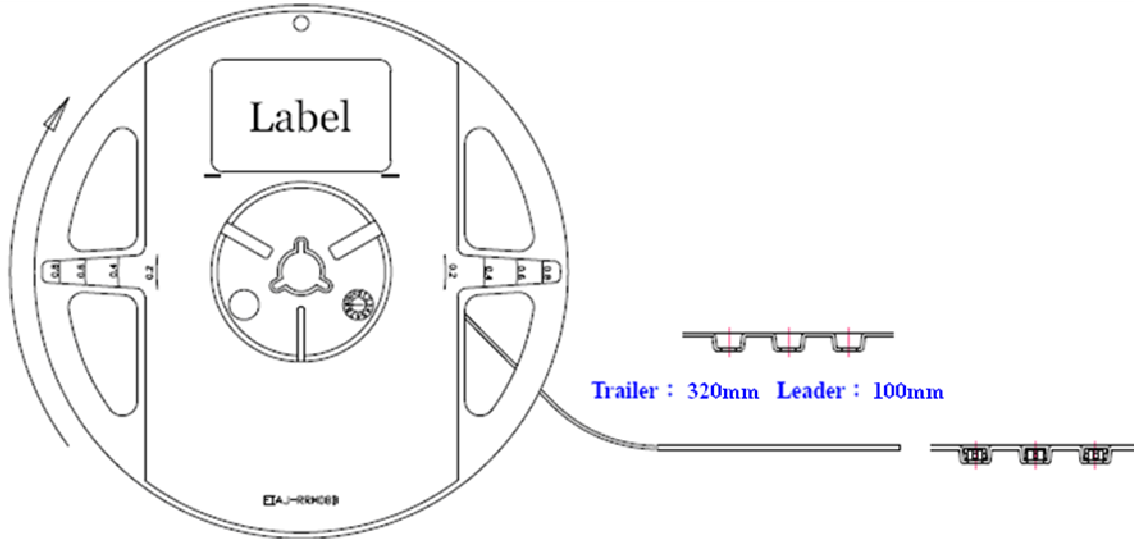

尺寸单位: mm

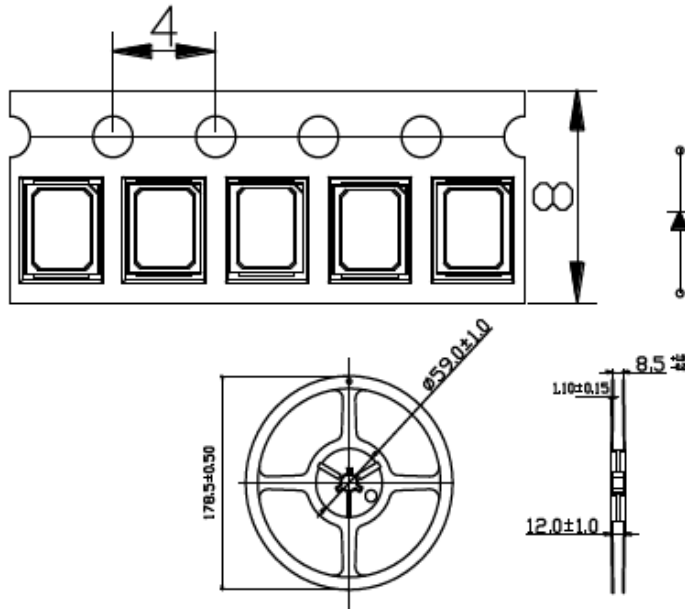

## Shield Bag Taping

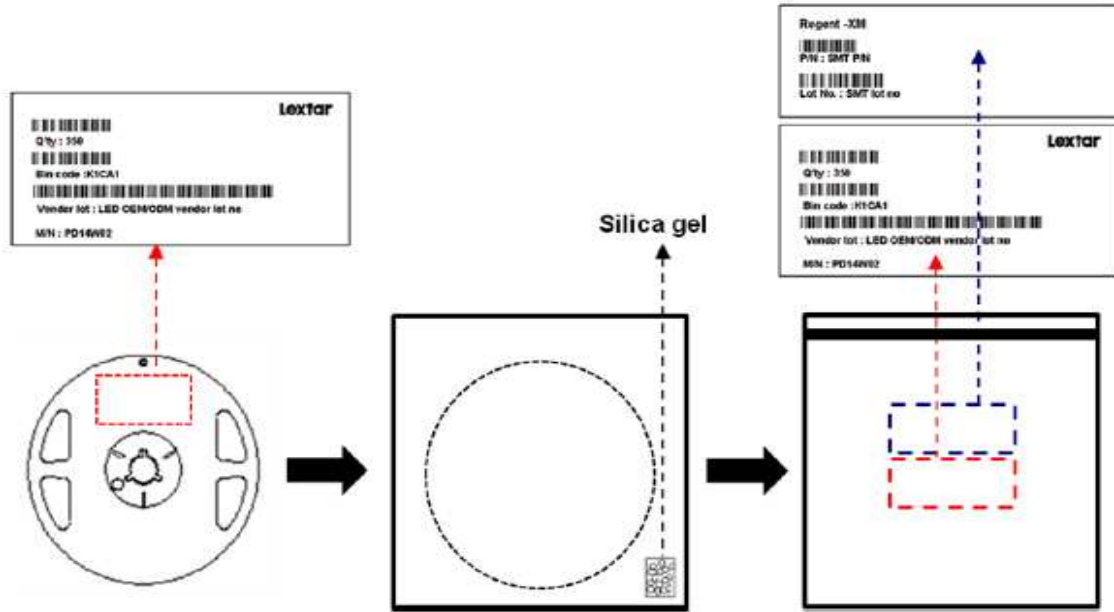

■ **Packing Box**

Type	Large Box		Medium Box		Small Box	
Dimension	541X511X276mm		385X303X260mm		283X235x70mm	
Maximum Reels	7"X12mm Reel	64/R	7"X12mm Reel	21/R	7"X12mm Reel	4/R
Minimum Reels	7"X12mm Reel	32/R	7"X12mm Reel	9/R	7"X12mm Reel	1/R

■ **Small Box**

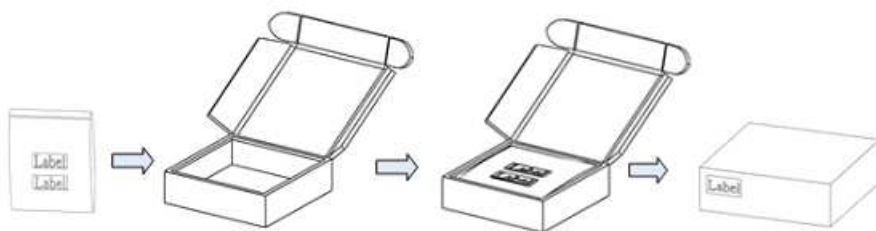

■ **Medium Box**

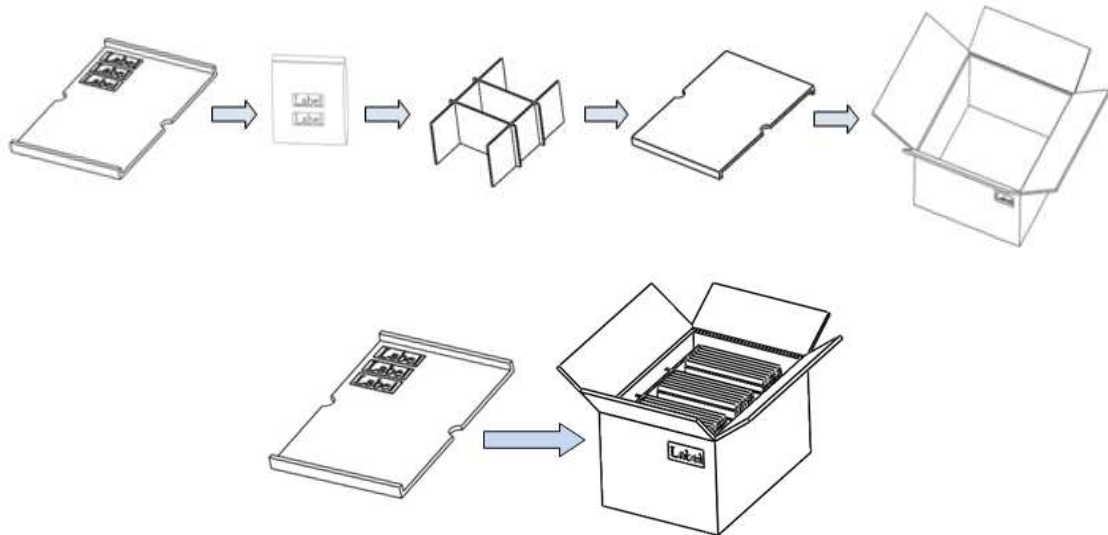

### ■ Large Box

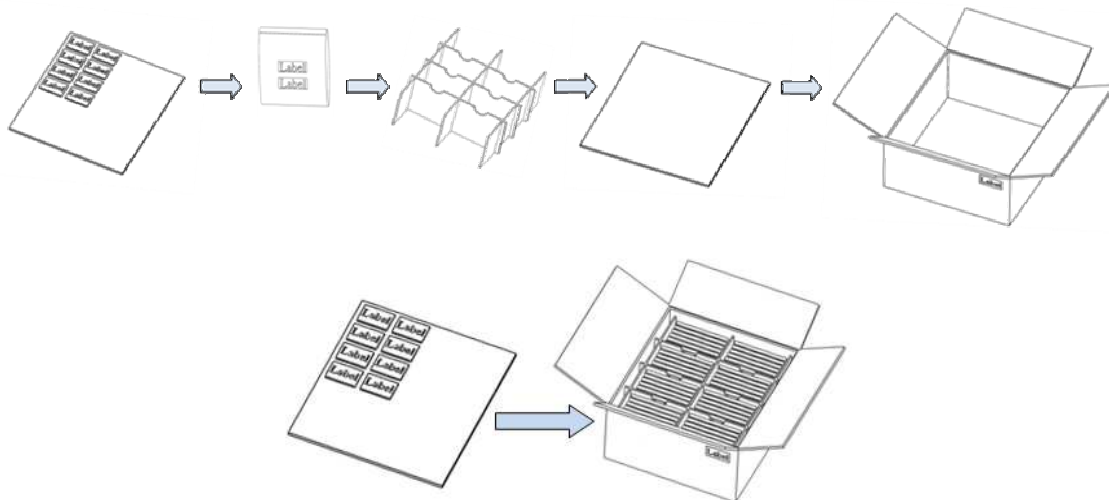

## Precautions

PC35H13 V0

Product Specification

### ■ Safety Precautions

- The LED light output is too strong for human eyes without shield. Prevent eye contact directly more than seconds.
- Ensure operating under maximum rating.

### ■ Storage

- Before opening the package, the LEDs should storage under 30°C, 60% RH.
- After opening the package bag, the LEDs should be keep under 30°C, 60% RH. Recommend to use within 168hrs. If unused LEDs remain, suggest to store into moisture proof bag or original package bag with moisture absorbent material such as silica gel. Reseal well is necessary.

- If the product exceeded the storage period or the moisture absorbent material faded away, baking treatment should be done by following conditions.  
Bake condition: 60°C , 12hours (One time only).

### ■ Soldering Notice and Conditions

- When soldering LEDs,
- Do not solder/reflow the same LED over two times.
- Recommend soldering conditions:  
Hand soldering: 350 °C max , 3 sec. max.  
Reflow soldering: Pre-heat 180 °C max , 180 sec. max.  
Peak 260 °C max , 5 sec. max.
- Reflow temperature profile as below: (lead-free solder)

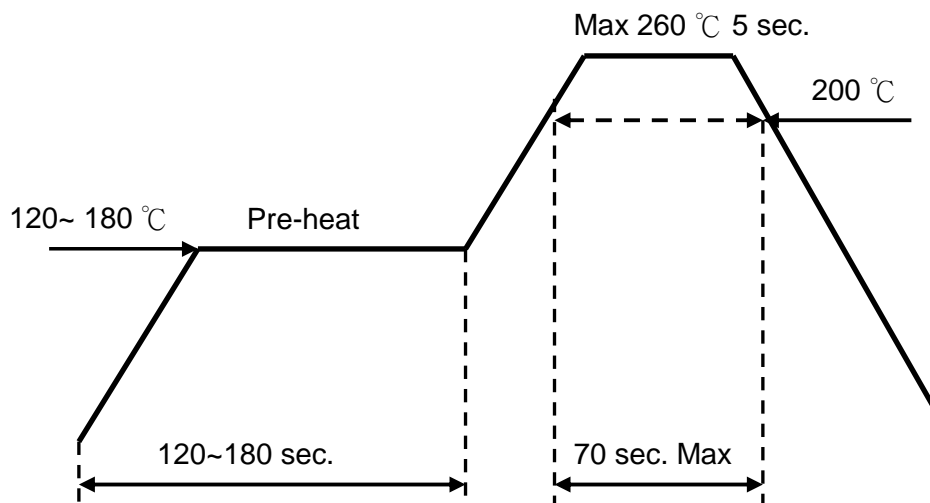

- When soldering, don't put stress on the LEDs
- After LEDs have been soldered, strongly recommend not to repair to keep the LEDs performance.

### ■ Static Electricity

- LED package is extremely sensitive to static electricity. It's recommended that anti-electrostatic glove and wrist band is necessary when handling the LEDs. All devices are also be grounded properly as well.
- Protection devices design should be considered in the LED driving circuit.

### ■ Cleaning

- If washing is required, recommend to use alcohol as a solvent.
- Recommend to avoid cleaning the LEDs by ultrasonic. If necessary, pre-test the LED is necessary to confirm whether any damage occur after the process.

## Revision History

PC35H13 V0  
Product Specification

Date	Contents	Writer	Approved
2015.03.21	New version	Rock Yen	Berris Huang
2015.10.13	Tolunce modify	Rock Yen	Berris Huang
2015.06.06	Luminous Flux Rank	Kenis Hung	Berris Huang
2017.08.02	Luminous Flux Rank	Josh Yang	Berris Huang

## *Smart Lighting* *Amazing Life*

Lextar Electronics Corp. is the leading LED (Light Emitting Diode) maker integrating upper stream epitaxial, middle stream chip, and downstream package, SMT and LED lighting applications. Founded in May, 2008, Lextar is a subsidiary of AU Optronics, the leading TFT-LCD and solar PV manufacturer. Lextar's product applications include lighting and LCD backlight. Lextar's manufacturing sites include Hsinchu and Chunan in Taiwan, and Suzhou in China. The company turnover in 2012 is 340 million USD.