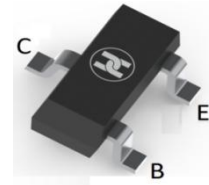
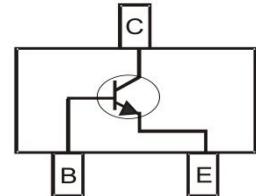

**BIPOLAR TRANSISTOR (NPN)**
**FEATURES**

- Complementary to BC860
- Ideally suited for automatic insertion
- For switching and AF amplifier applications
- Surface Mount device

**SOT-23**

**MECHANICAL DATA**

- Case: SOT-23
- Case Material: Molded Plastic. UL flammability
- Classification Rating: 94V-0
- Moisture Sensitivity: Level 1 per J-STD-020
- Weight: 0.008 grams (approximate)

**MAXIMUM RATINGS (T<sub>A</sub> = 25°C unless otherwise noted)**

Parameter	Symbol	Value	Unit
Collector-Base Voltage	V <sub>CB0</sub>	50	V
Collector-Emitter Voltage	V <sub>CEO</sub>	45	V
Emitter-Base Voltage	V <sub>EBO</sub>	5	V
Collector Current	I <sub>C</sub>	100	mA
Collector Power Dissipation	P <sub>D</sub>	300	mW
Thermal Resistance From Junction To Ambient	R <sub>θJA</sub>	417	°C/W
Junction Temperature	T <sub>J</sub>	150	°C
Storage Temperature	T <sub>STG</sub>	-55 ~+150	°C

**ELECTRICAL CHARACTERISTICS (T<sub>A</sub> = 25°C unless otherwise specified)**

Parameter	Symbol	Min	Typ	Max	Unit	Conditions
Collector-base breakdown voltage	V <sub>(BR)CBO</sub>	50			V	I <sub>C</sub> =10uA, I <sub>E</sub> =0
Collector-emitter breakdown voltage	V <sub>(BR)CEO</sub>	45			V	I <sub>C</sub> =10mA, I <sub>B</sub> =0
Emitter-base breakdown voltage	V <sub>(BR)EBO</sub>	5			V	I <sub>E</sub> =10uA, I <sub>C</sub> =0
Collector cut-off current	I <sub>CBO</sub>			15	nA	V <sub>CB</sub> =30V, I <sub>E</sub> =0
DC current gain	h <sub>FE1</sub>	200		800		V <sub>CE</sub> =5V, I <sub>C</sub> =2mA
Collector-emitter saturation voltage	V <sub>CE(sat)</sub>		0.09	0.25	V	I <sub>C</sub> =10mA, I <sub>B</sub> =0.5mA
			0.2	0.6	V	I <sub>C</sub> =100mA, I <sub>B</sub> =5mA
Base-emitter saturation voltage	V <sub>BE(sat)</sub>		0.7		V	I <sub>C</sub> =10mA, I <sub>B</sub> =0.5mA
			0.9		V	I <sub>C</sub> =100mA, I <sub>B</sub> =5mA
Base-emitter voltage	V <sub>BE(ON)</sub>	0.58	0.66	0.7	V	V <sub>CE</sub> =5V, I <sub>C</sub> =2mA
				0.77	V	V <sub>CE</sub> =5V, I <sub>C</sub> =10mA
Transition frequency	f <sub>T</sub>		300		MHz	V <sub>CE</sub> =5V, I <sub>C</sub> =10mA, f=100MHz
Collector output capacitance	C <sub>ob</sub>		2.5	4.5	pF	V <sub>CE</sub> =10V, I <sub>E</sub> =0, f=1MHz
Noise Figure	NF			1.0	dB	I <sub>C</sub> =0.2mA, V <sub>CE</sub> =5.0V R <sub>g</sub> =10kΩ, f=1.0kHz

**CLASSIFICATION OF h<sub>FE</sub>**

Rank	BC850B	BC850C
Range	110-220	420-800
Marking	2F	2G

**BIPOLAR TRANSISTOR (NPN)**

**Typical Characteristics**

**Static Characteristic**

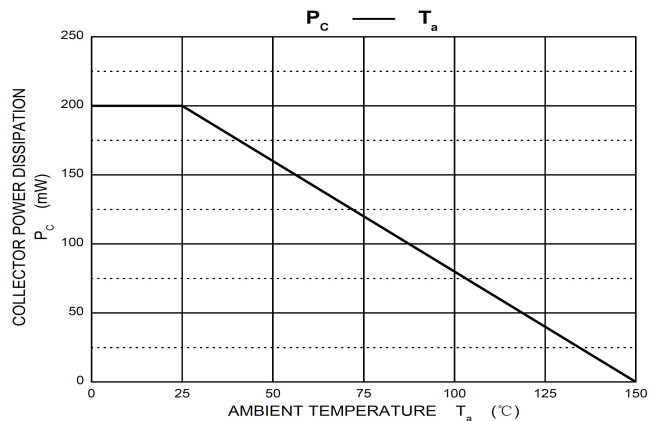
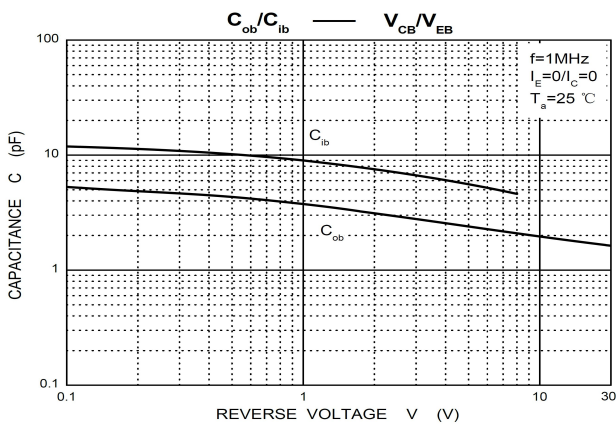
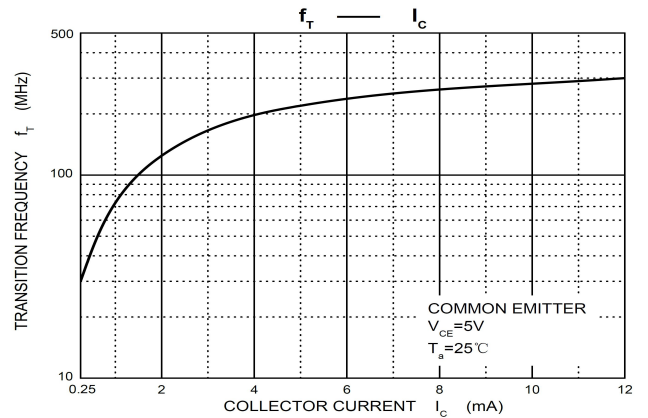
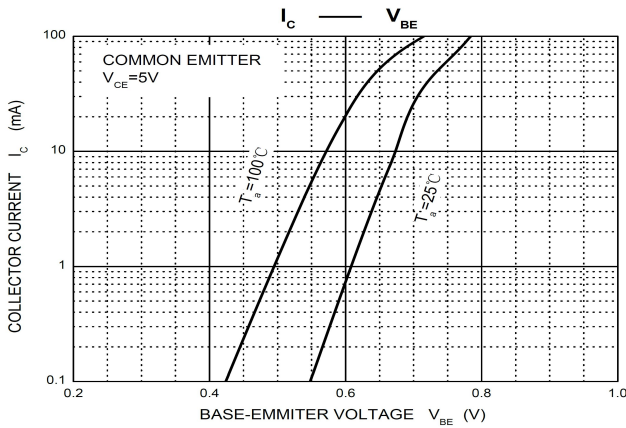
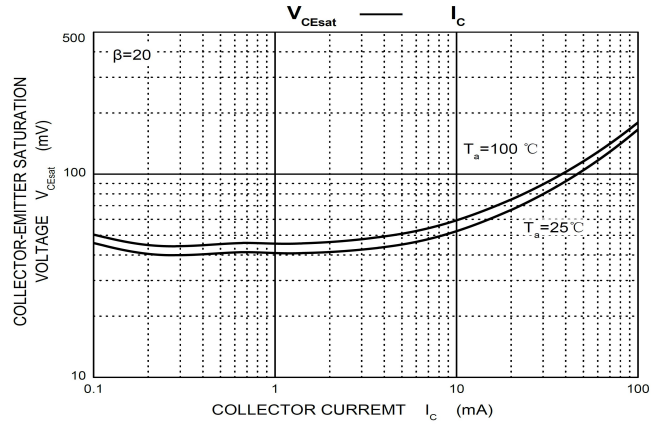
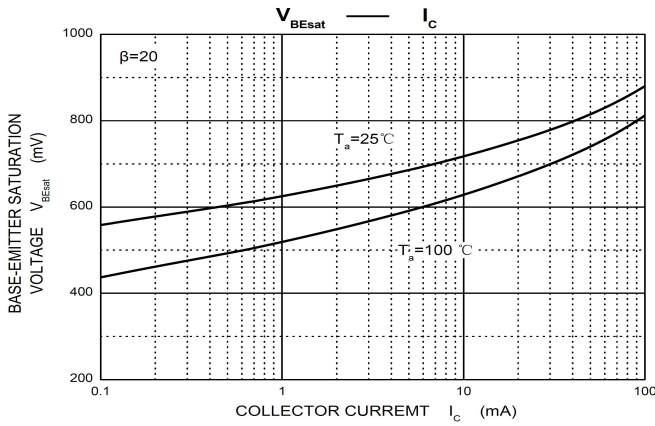
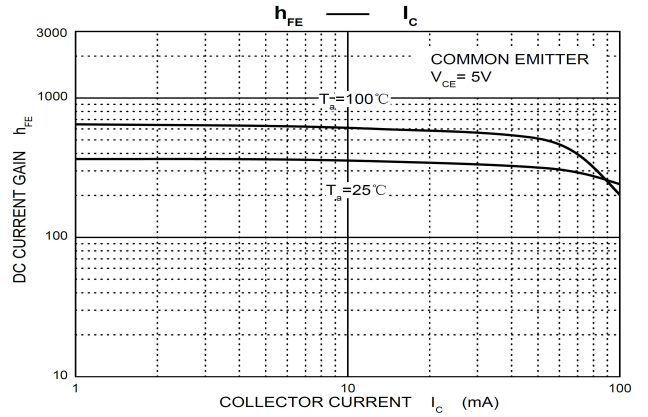
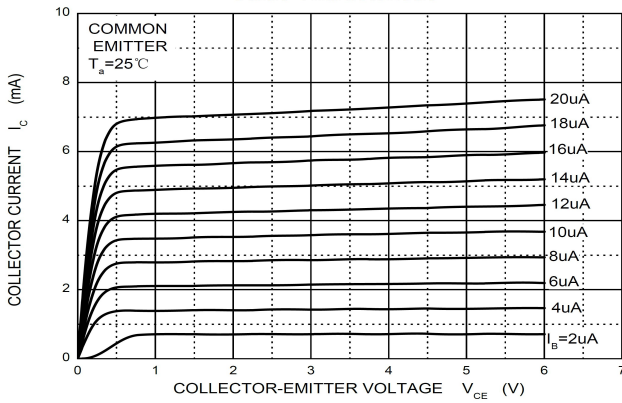

**BIPOLAR TRANSISTOR (NPN)**
**SOT-23 Package Outline Dimensions**

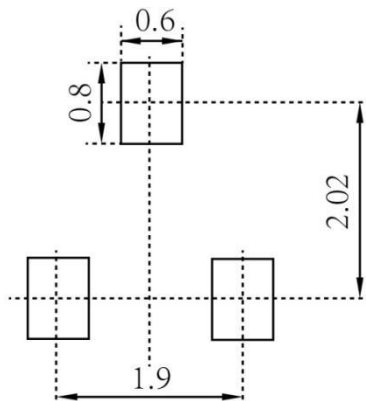

Symbol	Dimensions In Millimeters		Dimensions In Inches	
	Min.	Max.	Min.	Max.
A	0.900	1.150	0.035	0.045
A1	0.000	0.100	0.000	0.004
A2	0.900	1.050	0.035	0.041
b	0.300	0.500	0.012	0.020
c	0.080	0.150	0.003	0.006
D	2.800	3.000	0.110	0.118
E	1.200	1.400	0.047	0.055
E1	2.250	2.550	0.089	0.100
e	0.950 TYP		0.037 TYP	
e1	1.800	2.000	0.071	0.079
L	0.550 REF		0.022 REF	
L1	0.300	0.500	0.012	0.020
$\theta$	0°	8°	0°	8°

**SOT-23 Suggested Pad Layout**

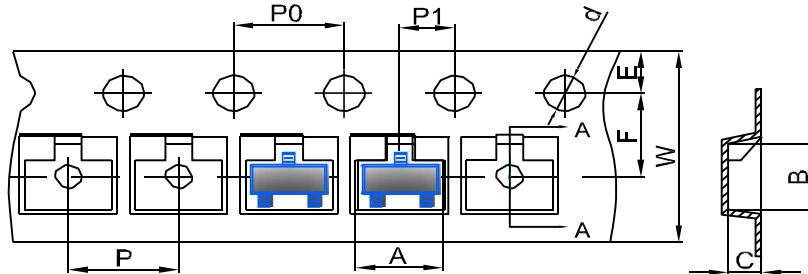
**Note:**

1. Controlling dimension: in millimeters
2. General tolerance:  $\pm 0.05\text{mm}$
3. The pad layout is for reference purposes only

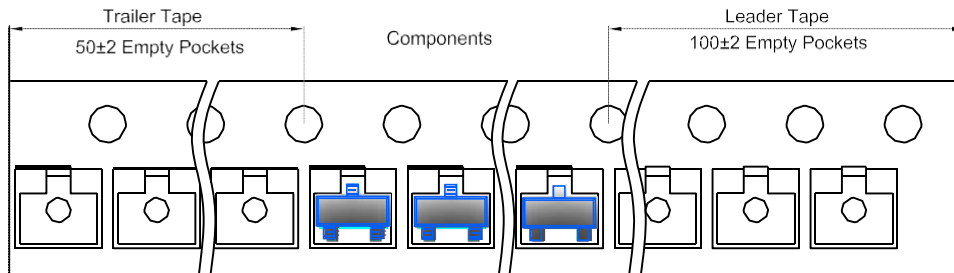
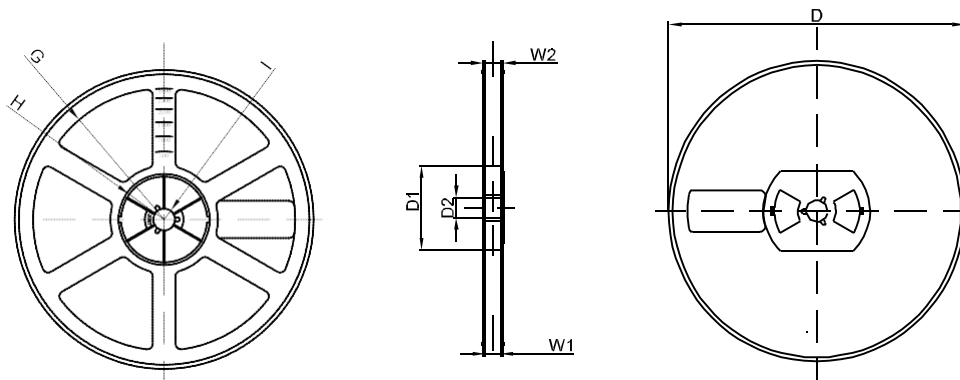
**BIPOLAR TRANSISTOR (NPN)**
**SOT-23 Tape and Reel**
**SOT-23 Embossed Carrier Tape**

DIMENSIONS ARE IN MILLIMETER										
TYPE	A	B	C	d	E	F	P0	P	P1	W
SOT-23	3.15	2.77	1.22	Ø1.50	1.75	3.50	4.00	4.00	2.00	8.00
TOLERANCE	±0.1	±0.1	±0.1	±0.1	±0.1	±0.1	±0.1	±0.1	±0.1	±0.1

**SOT-23 Tape Leader and Trailer**

**SOT-23 Reel**

DIMENSIONS ARE IN MILLIMETER								
REEL OPTION	D	D1	D2	G	H	I	W1	W2
7" DIA	Ø178	54.40	13.00	R78	R25.60	R6.50	9.50	12.30
TOLERANCE	±2	±1	±1	±1	±1	±1	±1	±1