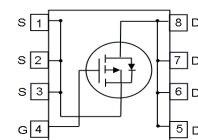
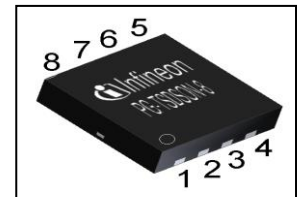

OptiMOS™ P3 Power-Transistor
Features

- single P-Channel in S3O8
- Qualified according JEDEC¹⁾ for target applications
- 150 °C operating temperature
- $V_{GS}=25$ V, specially suited for notebook applications
- Pb-free; RoHS compliant
- applications: battery management, load switching
- Halogen-free according to IEC61249-2-21

Product Summary

V_{DS}	-30	V
$R_{DS(on),max}$	8.6	mΩ
I_D	-40	A

PG-TSDSON-8

Type	Package	Marking	Lead free	Halogen free	Packing
BSZ086P03NS3 G	PG-TSDSON-8	086P3N	Yes	Yes	non-dry

Maximum ratings, at $T_j=25$ °C, unless otherwise specified

Parameter	Symbol	Conditions	Value	Unit
Continuous drain current	I_D	$T_C=25$ °C	-40	A
		$T_C=70$ °C	-40	
		$T_A=25$ °C ²⁾	-13.5	
Pulsed drain current	$I_{D,pulse}$	$T_C=25$ °C ³⁾	-160	
Avalanche energy, single pulse	E_{AS}	$I_D=-20$ A, $R_{GS}=25$ Ω	105	mJ
Gate source voltage	V_{GS}		±25	V
Power dissipation	P_{tot}	$T_A=25$ °C	69	W
		$T_A=25$ °C ²⁾	2.1	
Operating and storage temperature	T_j, T_{stg}		-55 ... 150	°C
ESD class		JESD22-A114 HBM	1C (1 kV - 2 kV)	
Soldering temperature			260	°C
IEC climatic category; DIN IEC 68-1			55/150/56	

¹⁾ J-STD20 and JESD22

Parameter	Symbol	Conditions	Values			Unit
			min.	typ.	max.	

Thermal characteristics

Thermal resistance, junction - case	R_{thJC}		-	-	1.8	K/W
Thermal resistance, junction - ambient	R_{thJA}	6 cm ² cooling area ²⁾	-	-	60	

Electrical characteristics, at $T_j=25\text{ °C}$, unless otherwise specified
Static characteristics

Drain-source breakdown voltage	$V_{(BR)DSS}$	$V_{GS}=0\text{ V}$, $I_D=-250\mu\text{A}$	-30	-	-	V
Gate threshold voltage	$V_{GS(th)}$	$V_{DS}=V_{GS}$, $I_D=-105\mu\text{A}$	-3.1	-2.5	-1.9	
Zero gate voltage drain current	I_{DSS}	$V_{DS}=-30\text{ V}$, $V_{GS}=0\text{ V}$, $T_j=25\text{ °C}$	-	-	-1	μA
		$V_{DS}=-30\text{ V}$, $V_{GS}=0\text{ V}$, $T_j=125\text{ °C}$	-	-	-10	
Gate-source leakage current	I_{GSS}	$V_{GS}=-25\text{ V}$, $V_{DS}=0\text{ V}$	-	-	-100	nA
Drain-source on-state resistance	$R_{DS(on)}$	$V_{GS}=-6\text{ V}$, $I_D=-20\text{ A}$	-	8.7	13.4	m Ω
		$V_{GS}=-10\text{ V}$, $I_D=-20\text{ A}$	-	6.5	8.6	
Gate resistance	R_G		-	2.2	-	Ω
Transconductance	g_{fs}	$ V_{DS} >2 I_D R_{DS(on)max}$, $I_D=-20\text{ A}$	30	43	-	S

²⁾ Device on 40 mm x 40 mm x 1.5 mm epoxy PCB FR4 with 6 cm² (one layer, 70 μm thick) copper area for drain connection. PCB is vertical in still air.

³⁾ See Fig. 3 for more detailed information

Parameter	Symbol	Conditions	Values			Unit
			min.	typ.	max.	

Dynamic characteristics

Input capacitance	C_{iss}	$V_{GS}=0\text{ V}, V_{DS}=-15\text{ V},$ $f=1\text{ MHz}$	-	3190	4785	pF
Output capacitance	C_{oss}		-	1520	2280	
Reverse transfer capacitance	C_{rss}		-	110	165	
Turn-on delay time	$t_{d(on)}$	$V_{DD}=-15\text{ V}, V_{GS}=-$ $10\text{ V}, I_D=-20\text{ A},$ $R_{G,ext}=6\ \Omega$	-	16	24	ns
Rise time	t_r		-	46	69	
Turn-off delay time	$t_{d(off)}$		-	35	53	
Fall time	t_f		-	8	12	

Gate Charge Characteristics³⁾

Gate to source charge	Q_{gs}	$V_{DD}=-15\text{ V}, I_D=20\text{ A},$ $V_{GS}=0\text{ to }-10\text{ V}$	-	16.1	21.4	nC
Gate charge at threshold	$Q_{g(th)}$		-	5.0	6.7	
Gate to drain charge	Q_{gd}		-	7.4	11.1	
Switching charge	Q_{sw}		-	18.4	25.7	
Gate charge total	Q_g		-	43.2	57.5	
Gate plateau voltage	$V_{plateau}$		-	-4.5	-	V
Output charge	Q_{oss}	$V_{DD}=-15\text{ V}, V_{GS}=0\text{ V}$	-	34.9	46.4	nC

Reverse Diode

Diode continuous forward current	I_S	$T_C=25\text{ }^\circ\text{C}$	-	-	40	A
Diode pulse current	$I_{S,pulse}$		-	-	160	
Diode forward voltage	V_{SD}	$V_{GS}=0\text{ V}, I_F=-40\text{ A},$ $T_j=25\text{ }^\circ\text{C}$	-	-	-1.1	V
Reverse recovery time	t_{rr}	$V_R=15\text{ V}, I_F= I_S ,$ $di_F/dt=100\text{ A}/\mu\text{s}$	-	39	-	ns
Reverse recovery charge	Q_{rr}		-	34	-	nC

1 Power dissipation

$P_{tot}=f(T_C); t_p \leq 10 \text{ s}$

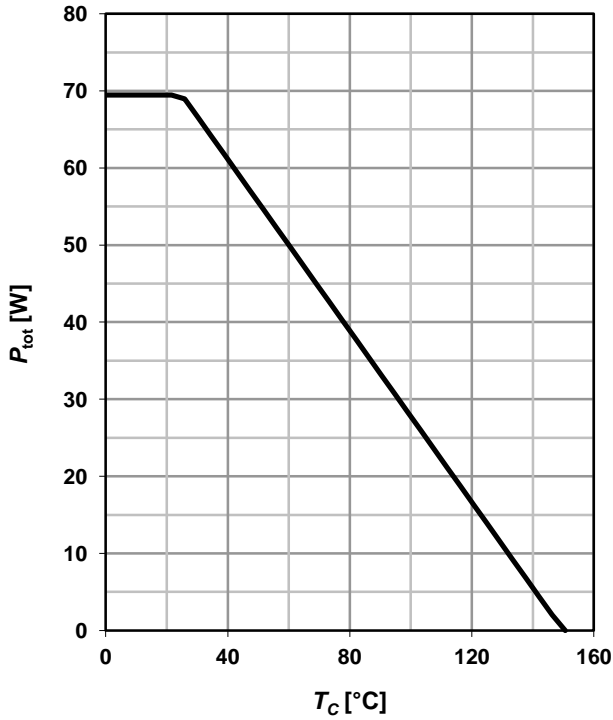

2 Drain current

$I_D=f(T_C); |V_{GS}| \geq 10 \text{ V}; t_p \leq 10 \text{ s}$

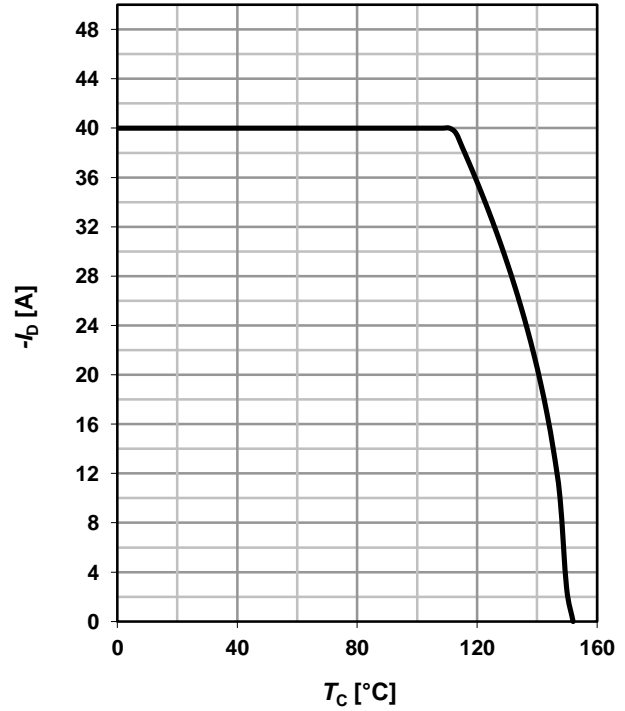

3 Safe operating area

$I_D=f(V_{DS}); T_C=25 \text{ }^\circ\text{C}^1); D=0$

parameter: t_p

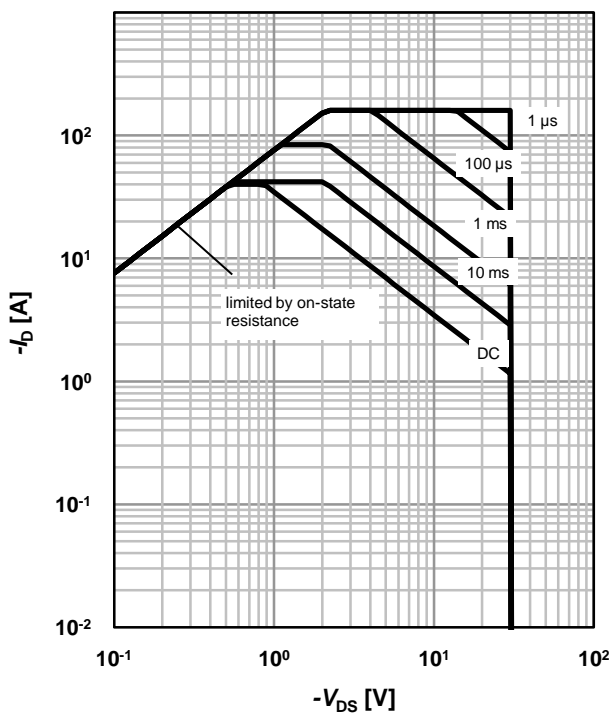

4 Max. transient thermal impedance

$Z_{thJS}=f(t_p)$

parameter: $D=t_p/T$

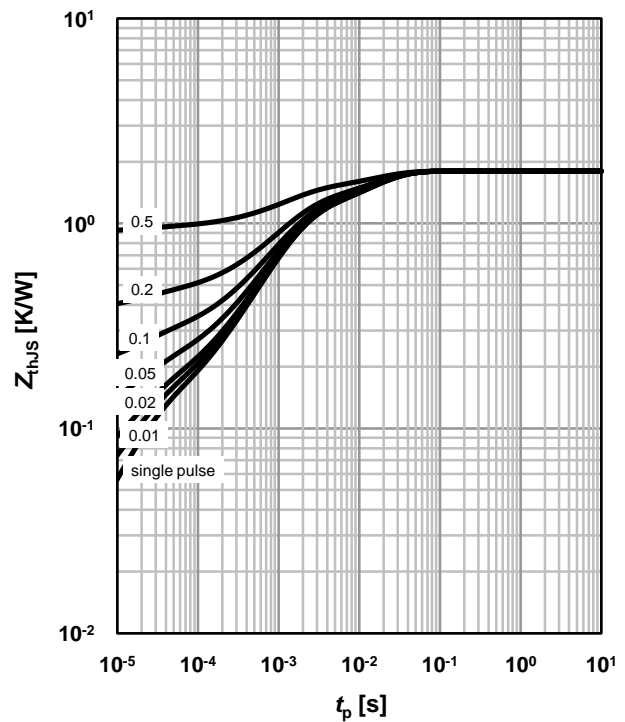

5 Typ. output characteristics

$I_D = f(V_{DS}); T_j = 25\text{ °C}$

parameter: V_{GS}

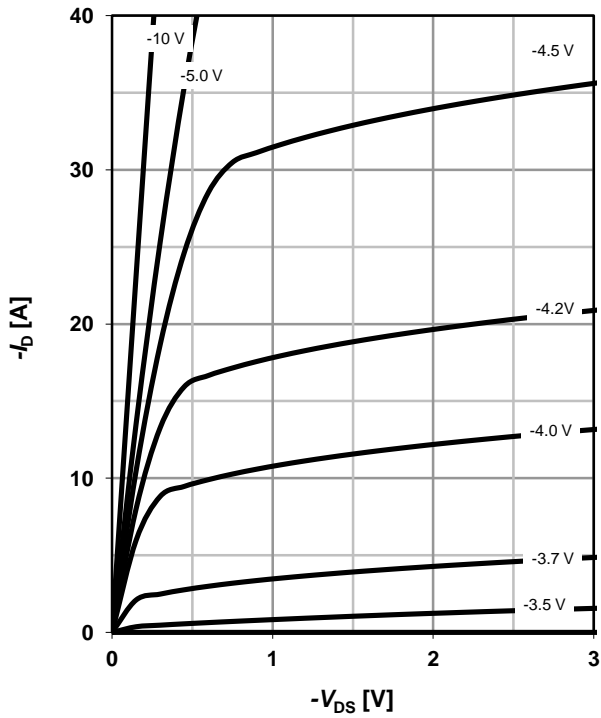

6 Typ. drain-source on resistance

$R_{DS(on)} = f(I_D); T_j = 25\text{ °C}$

parameter: V_{GS}

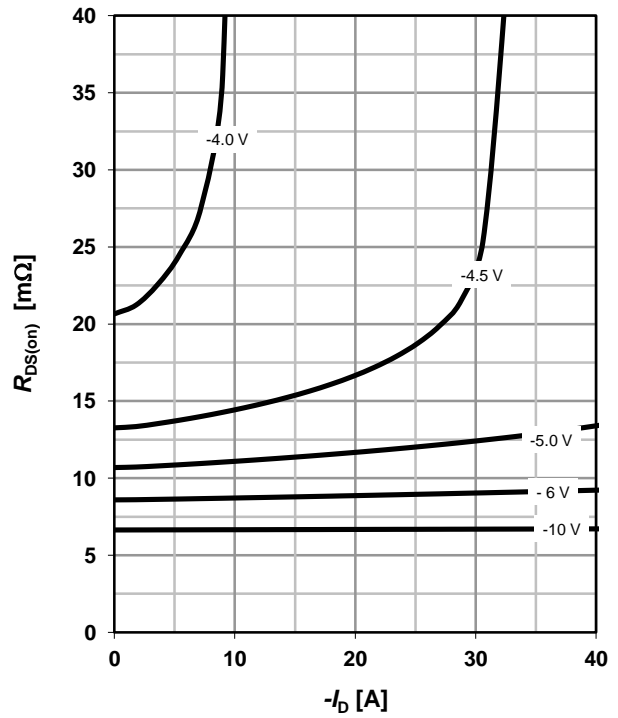

7 Typ. transfer characteristics

$I_D = f(V_{GS}); |V_{DS}| > 2|I_D|R_{DS(on)max}$

parameter: T_j

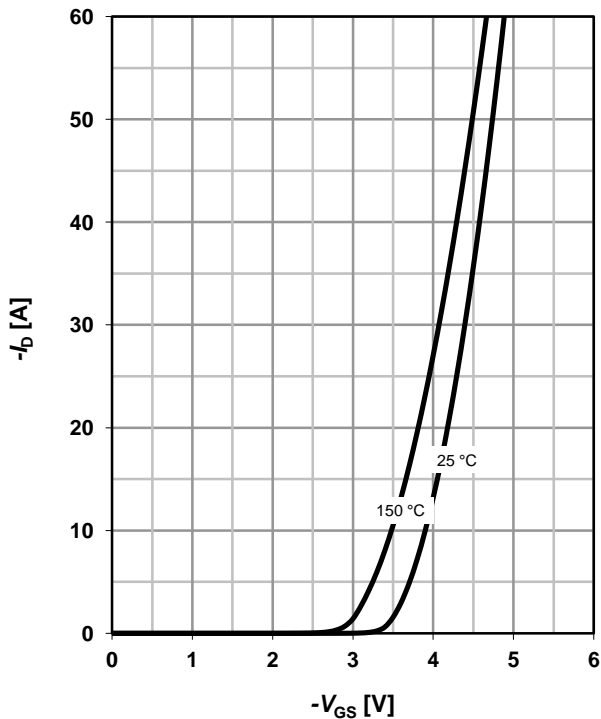

8 Typ. forward transconductance

$g_{fs} = f(I_D); T_j = 25\text{ °C}$

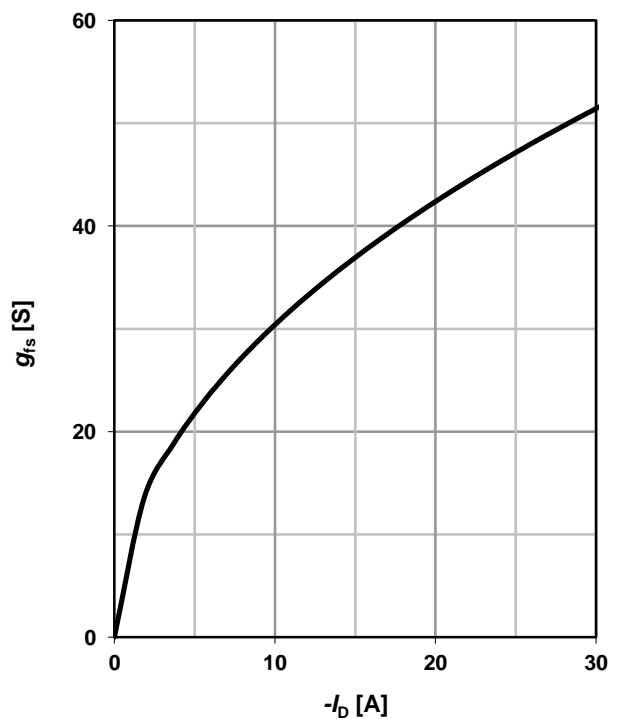

9 Drain-source on-state resistance

$R_{DS(on)}=f(T_j); I_D=-20\text{ A}; V_{GS}=-10\text{ V}$

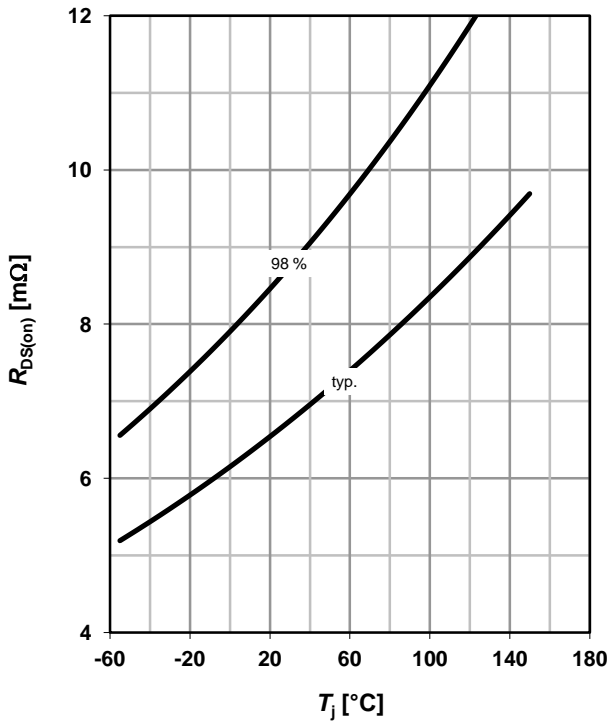

10 Typ. gate threshold voltage

$V_{GS(th)}=f(T_j); V_{GS}=V_{DS}; I_D=-105\ \mu\text{A}$

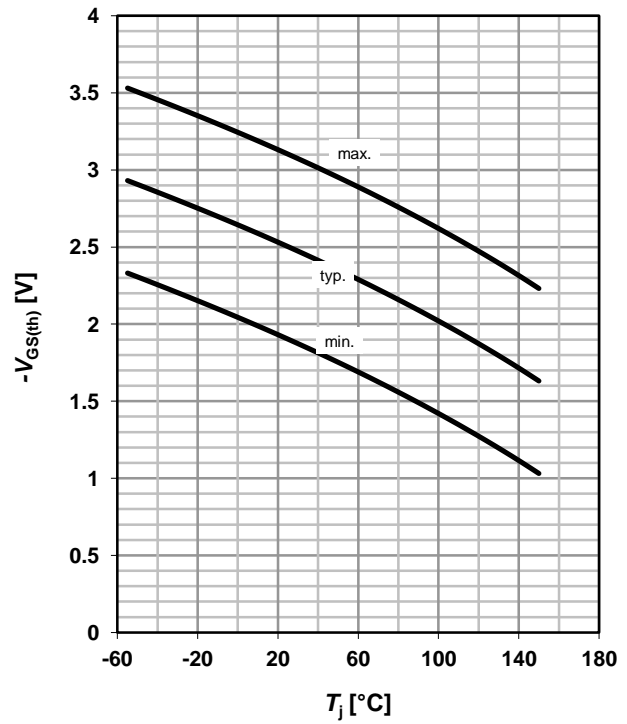

11 Typ. capacitances

$C=f(V_{DS}); V_{GS}=0\text{ V}; f=1\text{ MHz}$

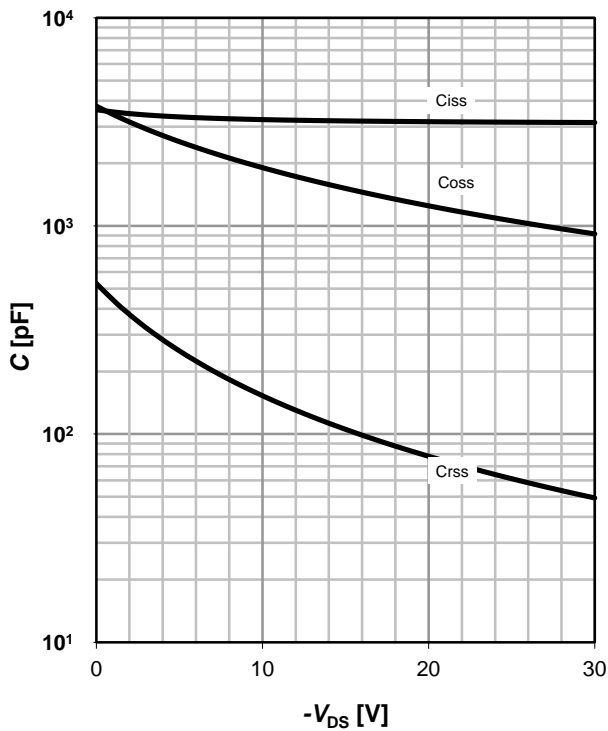

12 Forward characteristics of reverse diode

$I_F=f(V_{SD})$

parameter: T_j

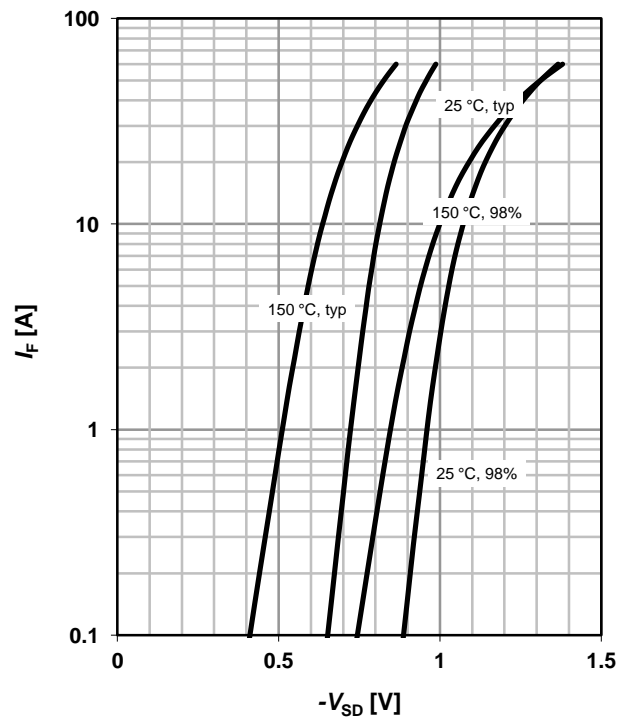

13 Avalanche characteristics

$I_{AS}=f(t_{AV}); R_{GS}=25 \Omega$

parameter: $T_{j(\text{start})}$

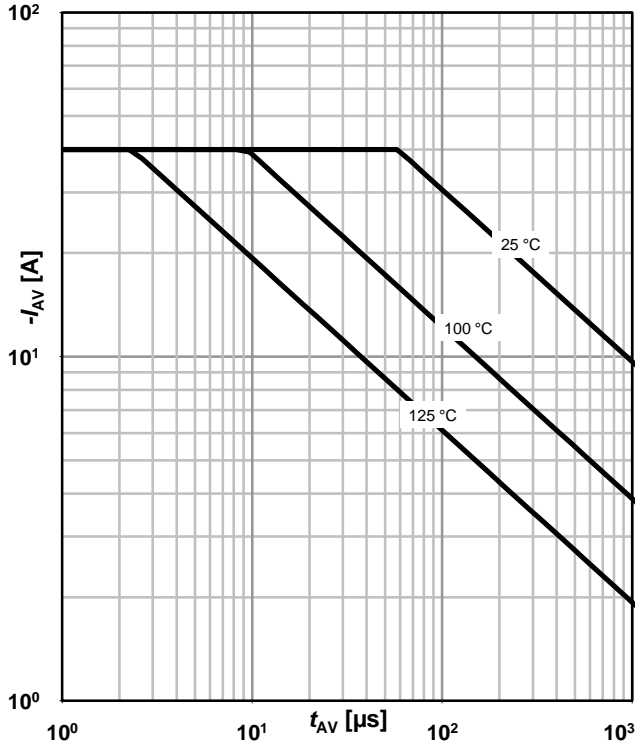

14 Typ. gate charge

$V_{GS}=f(Q_{\text{gate}}); I_D=-20 \text{ A pulsed}$

parameter: V_{DD}

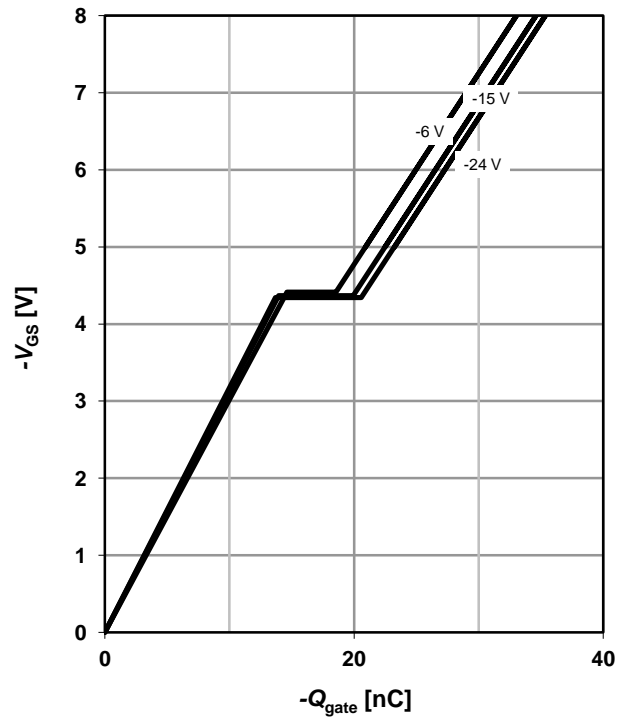

15 Drain-source breakdown voltage

$V_{BR(DSS)}=f(T_j); I_D=-250 \mu\text{A}$

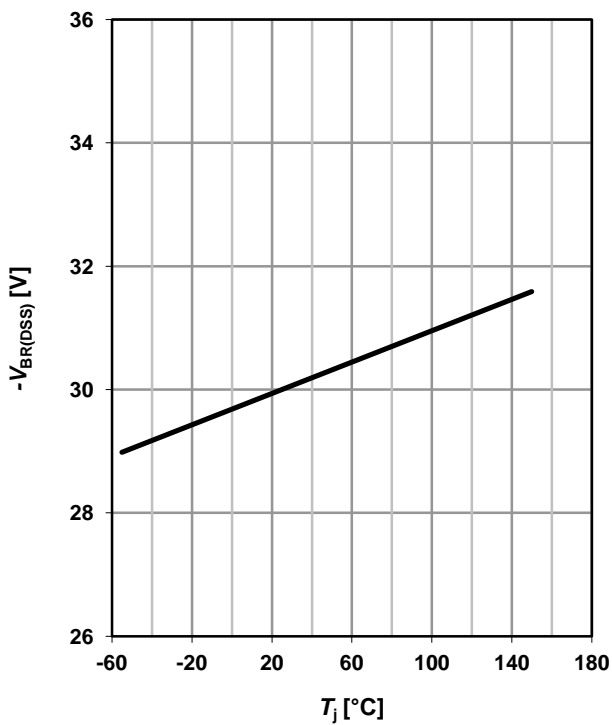

16 Gate charge waveforms

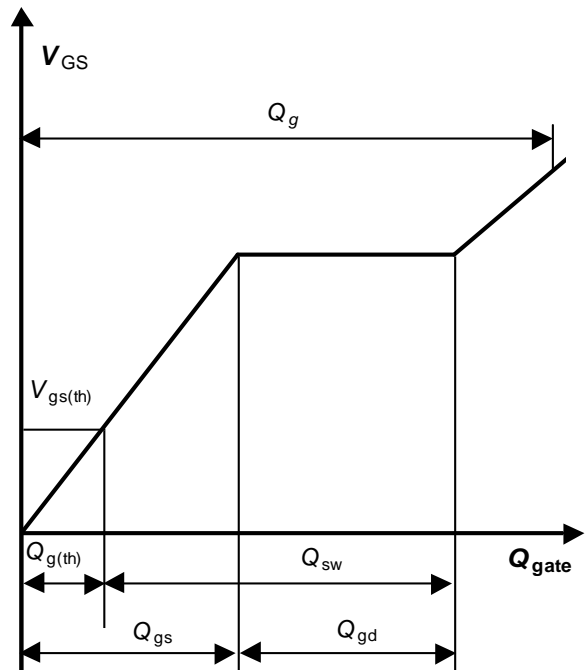

Package Outline

PG-TSDSON-8

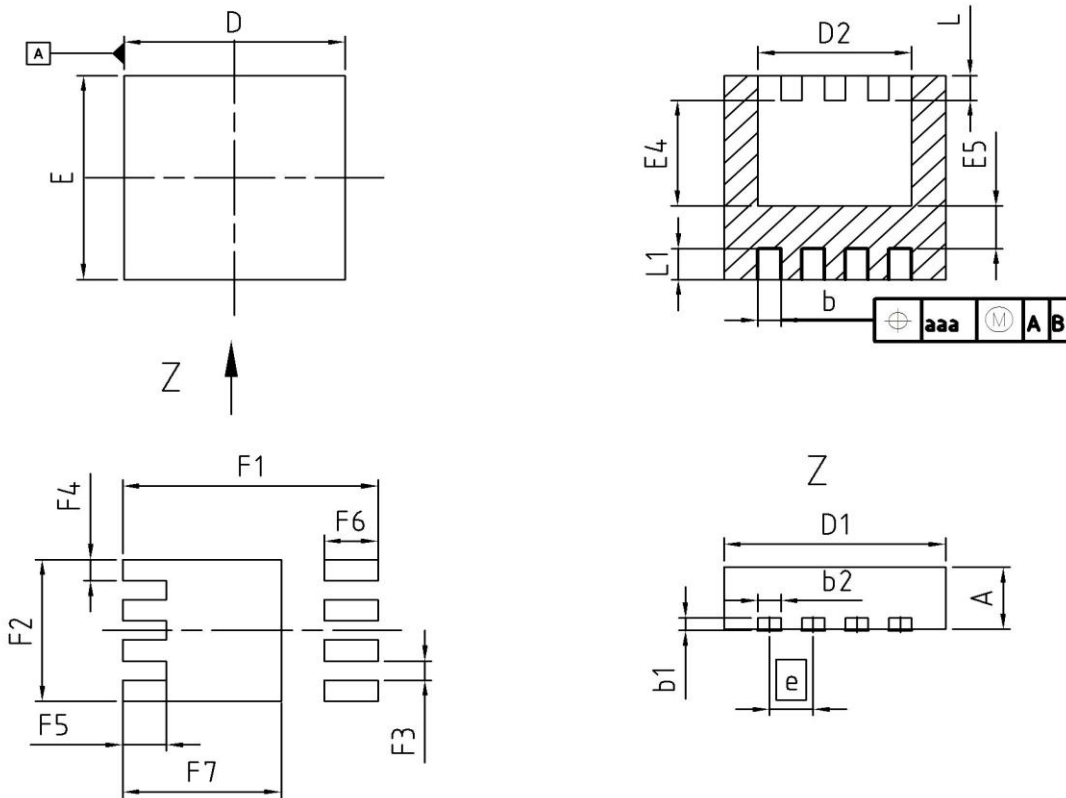

DIM	MILLIMETERS		INCHES	
	MIN	MAX	MIN	MAX
A	0.90	1.10	0.035	0.043
b	0.24	0.44	0.009	0.017
b1	0.10	0.30	0.004	0.012
b2	0.20	0.44	0.008	0.017
D=D1	3.20	3.40	0.126	0.134
D2	2.15	2.45	0.085	0.096
E	3.20	3.40	0.126	0.134
E4	1.60	1.81	0.063	0.071
E5	0.59	0.86	0.023	0.034
e	0.65		0.026	
N	8		8	
L	0.30	0.56	0.012	0.022
L1	0.33	0.60	0.013	0.024
aaa	0.25		0.010	
F1	3.80		0.150	
F2	2.29		0.090	
F3	0.31		0.012	
F4	0.34		0.013	
F5	0.65		0.026	
F6	0.80		0.031	
F7	2.36		0.093	

DOCUMENT NO.
Z8B00131645

SCALE

EUROPEAN PROJECTION

ISSUE DATE
17-09-2008

REVISION
02

Published by
Infineon Technologies AG
81726 Munich, Germany
© 2009 Infineon Technologies AG
All Rights Reserved.

Legal Disclaimer

The information given in this document shall in no event be regarded as a guarantee of conditions or characteristics. With respect to any examples or hints given herein, any typical values stated herein and/or any information regarding the application of the device, Infineon Technologies hereby disclaims any and all warranties and liabilities of any kind, including without limitation, warranties of non-infringement of intellectual property rights of any third party.

Information

For further information on technology, delivery terms and conditions and prices, please contact the nearest Infineon Technologies Office (www.infineon.com).

Warnings

Due to technical requirements, components may contain dangerous substances. For information on the types in question, please contact the nearest Infineon Technologies Office. Infineon Technologies components may be used in life-support devices or systems only with the express written approval of Infineon Technologies, if a failure of such components can reasonably be expected to cause the failure of that life-support device or system or to affect the safety or effectiveness of that device or system. Life support devices or systems are intended to be implanted in the human body or to support and/or maintain and sustain and/or protect human life. If they fail, it is reasonable to assume that the health of the user or other persons may be endangered.

Mouser Electronics

Authorized Distributor

Click to View Pricing, Inventory, Delivery & Lifecycle Information:

[Infineon:](#)

[BSZ086P03NS3 G](#)