

# 产品规格书 Product Specification



## Data Sheet – GLA Series

Model No.: GLA-6510  
GLA-6520  
GLA-6530

### Features & Typical Applications:

- High Efficiency
- Available with 3 beam angles
- With holder
- Commercial Lighting
- Optical PMMA material
- Vacuum aluminum plating+ UV coating
- Dia65mm\* H15.5mm

# 产品规格书 Product Specification

## Mechanical Specification : GLA-6510 / GLA-6520 / GLA-6530

- 1) All dimensions are in mm
- 2) All tolerance are  $\pm 0.2\text{mm}$  unless otherwise specified

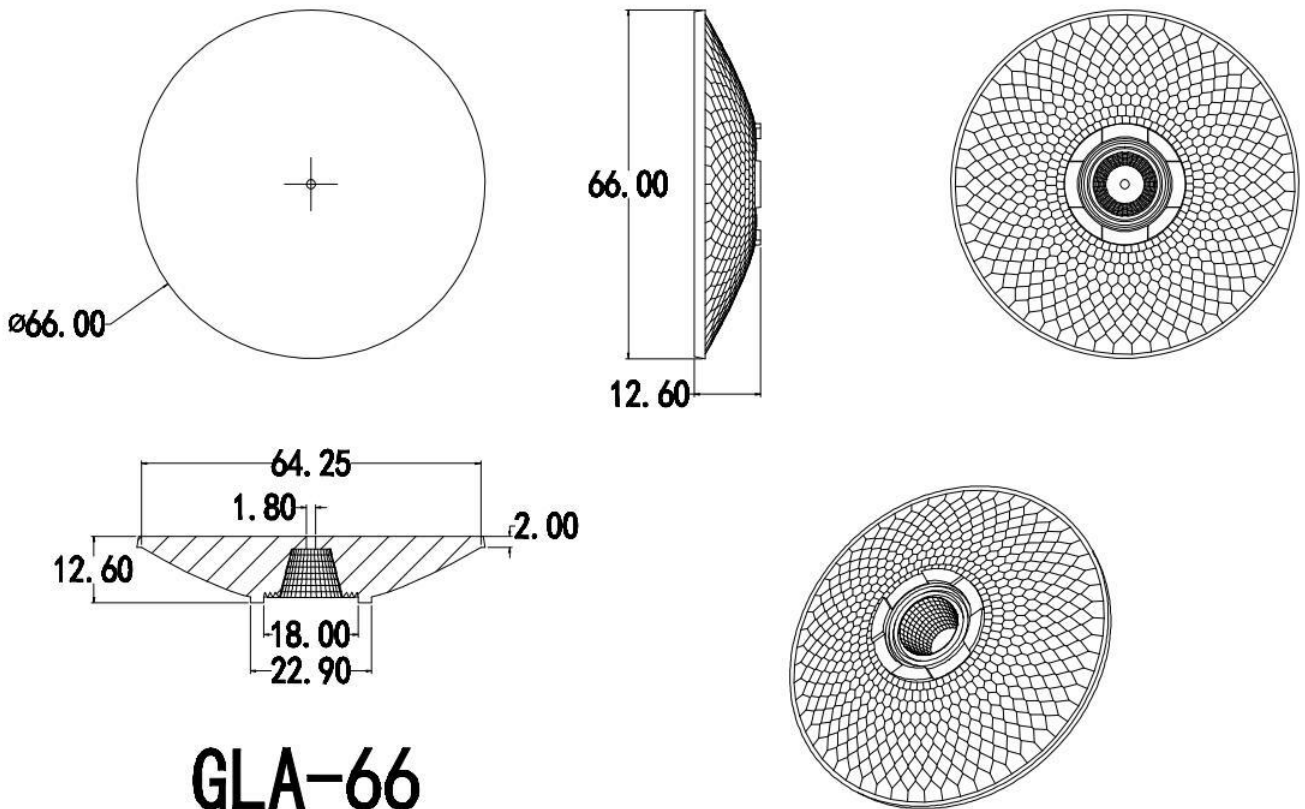

# GLA-66

# 产品规格书 Product Specification

## Optical Specification :



**CLL022: LES 11mm**

**GLA-6510  
FWHM 12°**

Luminous Intensity Distribution Curve(cd/klm)

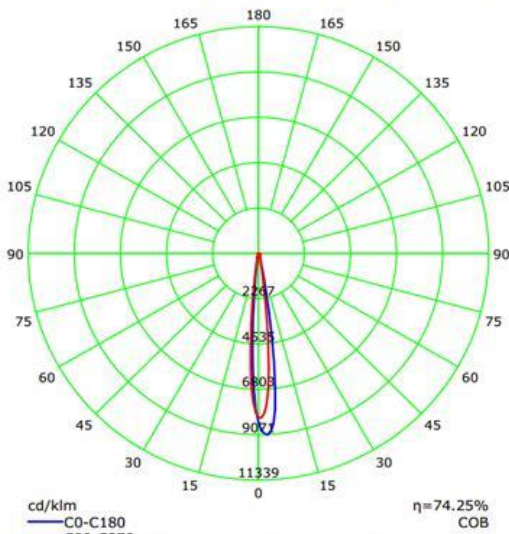

Illuminance at a Distance

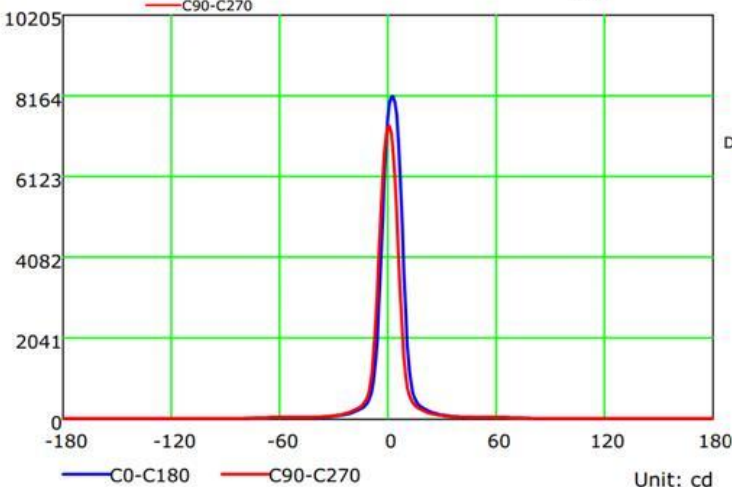
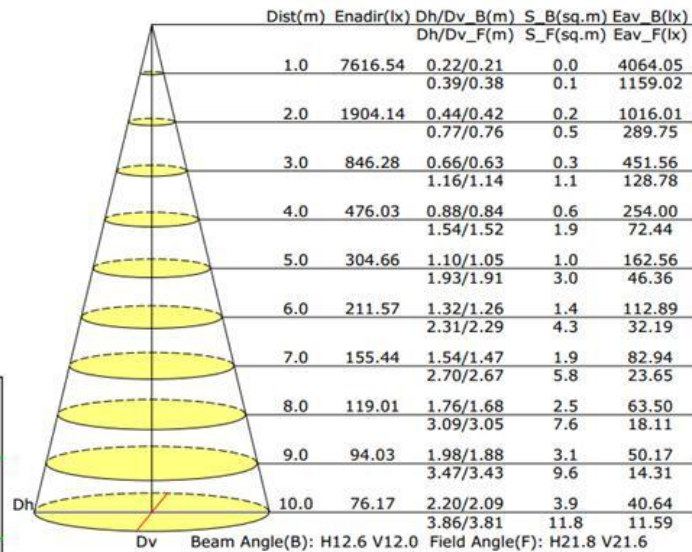

# 产品规格书 Product Specification

## Optical Specification :



**CLL022: LES 11mm**

**GLA-6520  
FWHM 20°**

Luminous Intensity Distribution Curve(cd/klm)

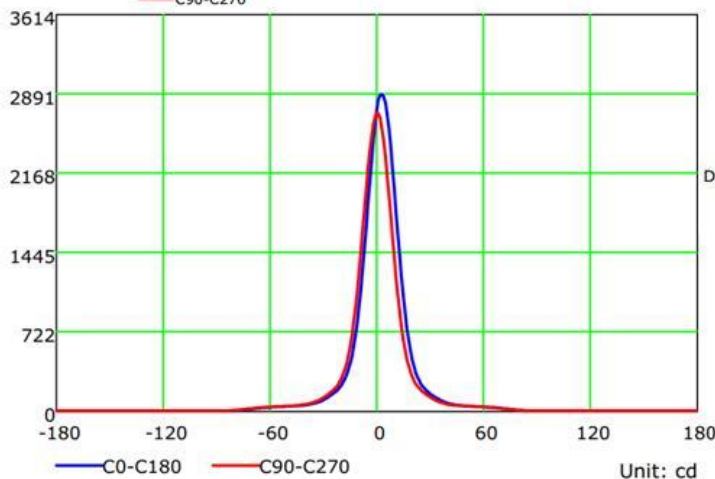
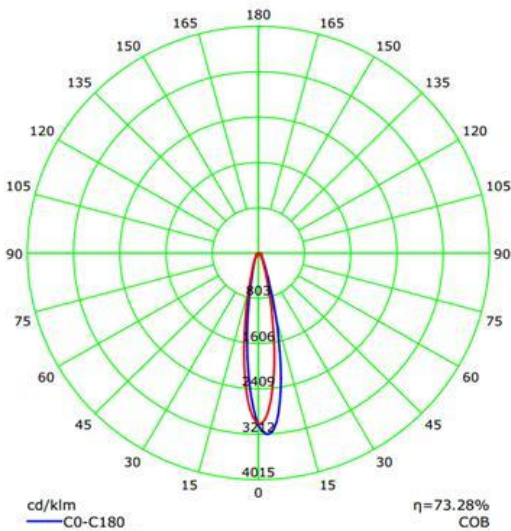

Illuminance at a Distance

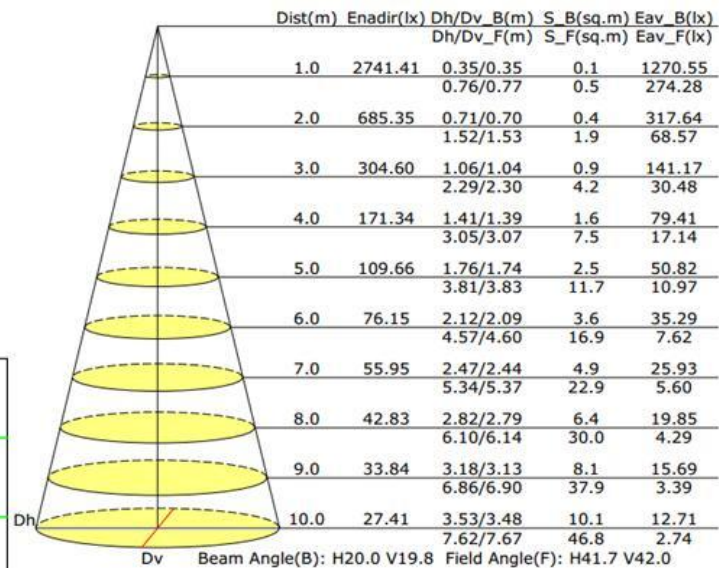



# 产品规格书 Product Specification

## Optical Specification :



**CLL022: LES 11mm**

**GLA-6530  
FWHM 31.2°**

Luminous Intensity Distribution Curve(cd/klm)

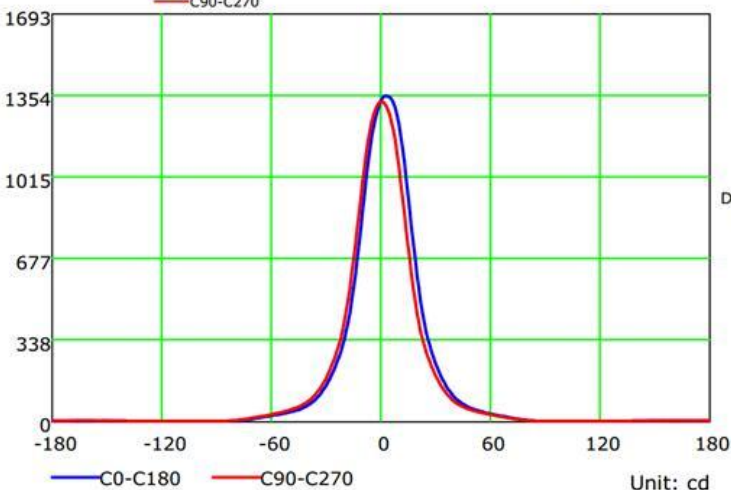
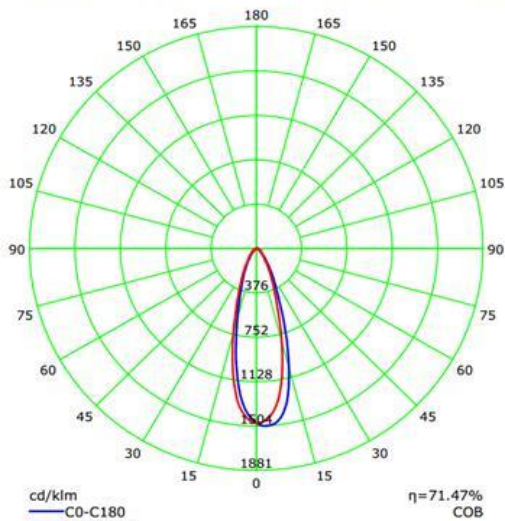

Illuminance at a Distance

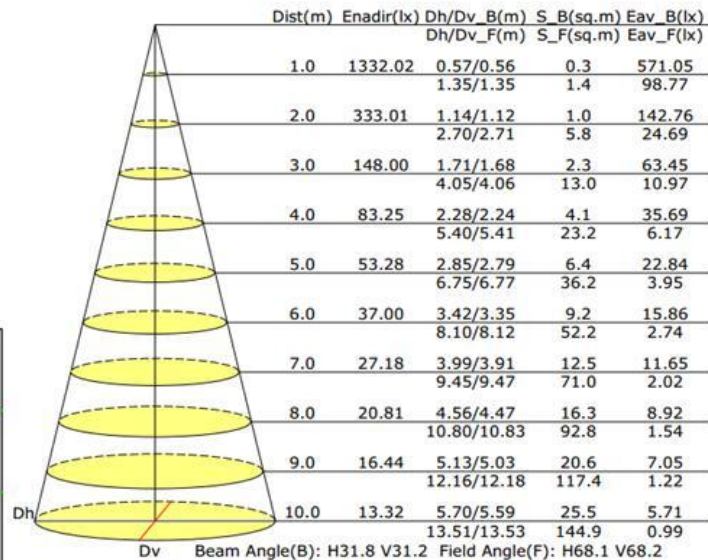

# 产品规格书 Product Specification

## Package Specifications

Item	Quantity	Total	Size	G.W
Small box	120pcs	120pcs	32*24.5*12.3	3.25
Outer box	6 small/outer box	720pcs	51*34*41	20.32

### Packing Details

