

DETAILS

Product Number	C14605_HB-2X2-RW
Family	HighBay
Type	Lens array
Color	clear
Diameter	50x50 mm
Height	8,5 mm
Style	square
Optic Material	PMMA
Holder Material	
Fastening	pin, screw
Status	production ready
ROHS Compliant	Yes
Date Updated	21/04/2016



OPTICAL PROPERTIES

LED	Viewing	Light	Effi-		Connector
	Angle	Beam	ciency	cd/lm	
SMD 5050	56 deg	Wide	94 %	0.940	-
XP-L	sim: 55	Wide	sim: 93 %	sim: 1.080	-
XM-L	sim: 54	Wide	sim: 92 %	sim: 1.180	-
XHP35 HD	sim: 59	Wide	sim: 91 %	sim: 1.000	-
XHP35 HI	sim: 52	Wide	sim: 93 %	sim: 1.400	-
XP-G3	48 deg	Wide	86 %	1.200	-
XP-L2	52 deg	Wide	92 %	1.000	-
LUXEON 5050	55 deg	Wide	94 %	0.990	-
NVSW3x9A	50 deg	Wide	93 %	1.200	-
Duris S8	sim: 53	Wide	sim: 91 %	sim: 1.100	-
Oslon Square Gen3	49 deg	Wide	94 %	1.300	-
Fortimo FastFlex LED board 2x8 DA G4	45 deg	Wide	93 %	1.400	-
Fortimo FastFlex LED board 2x8 DAX G4	sim: 51	Wide	sim: 94 %	sim: 1.300	-
LH351B	45 deg	Wide	86 %	1.320	-
LH351D	49 deg	Wide	94 %	sim: 1.200	-
LH508A	56 deg	Wide	93 %	0.950	-
Z8Y22P	48 deg	Wide	92 %	1.200	-
RLE G1 49x223mm 4000lm xxx EXC OT	46 deg	Wide	94 %	1.400	-
RLE G1 49x245mm 4000lm xxx EXC OT	46 deg	Wide	94 %	1.400	-
RLE G1 49x121mm 2000lm xxx EXC OT	46 deg	Wide	94 %	1.400	-
RLE G1 49x133mm 2000lm xxx EXC OT	46 deg	Wide	94 %	1.400	-

D

C

B

A

4

4

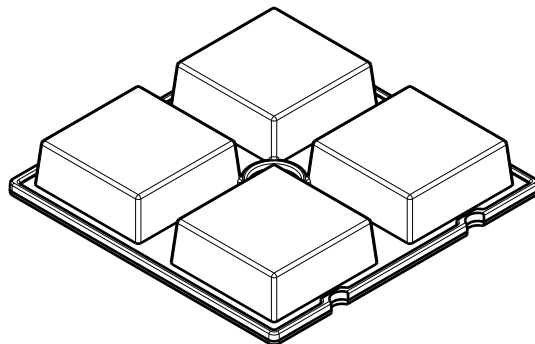
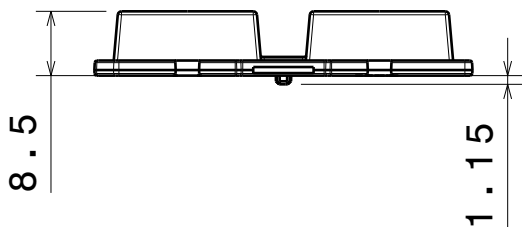

3

3

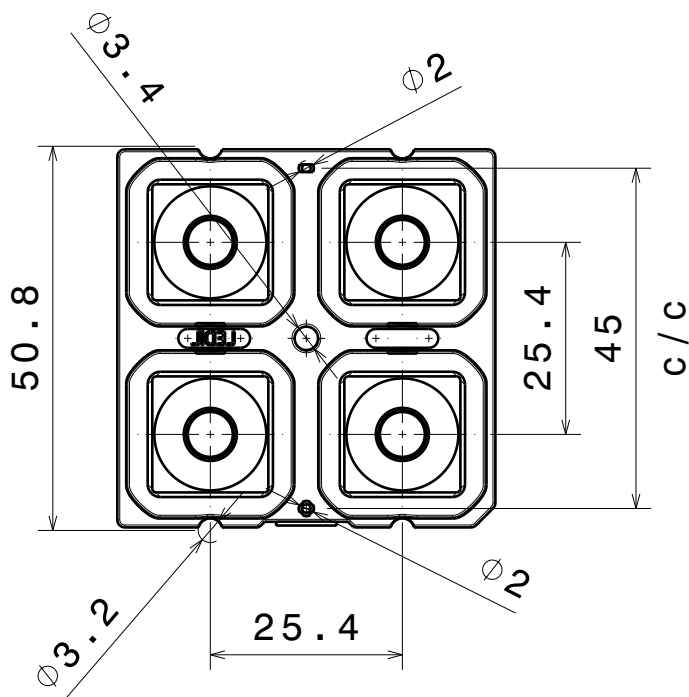
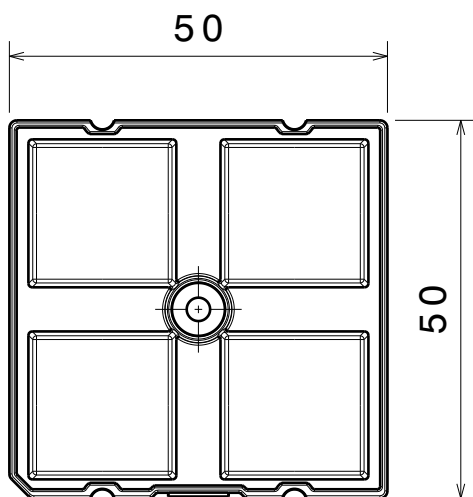

2

2

INDEX	PART NO	DESCRIPTION	MATERIAL	COLOUR
1	C14605	HB-2x2-RW	PMMA	

Tolerances if not otherwise shown
According to DIN ISO 2768-1
Linear measures:
up to 30mm class M, otherwise class C
According to DIN ISO 2768-2
Form and position: class L

LEDiL

Ledil Oy
Salorankatu 10
FIN 24240 SALO
Finland

THIRD ANGLE PROJECTION:

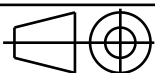

DRAWING TITLE

C14605_HB-2x2-RW

This drawing is the property
of LEDiL Oy. It may not be
reproduced, copied or
communicated without a written
agreement with LEDiL Oy.

SIZE PART NUMBER

A4

C14605

SCALE	1:1	WEIGHT	10,33 g	SHEET	1/1
-------	-----	--------	---------	-------	-----

1

1

D

A

Luminaire: LEDiL Oy C14605_HB-2X2-RW_(Bridgelux_5050_Gen2)

Lamps: 1 x Bridgelux_5050_Gen2_2x2_(BXEP-57C-435-09B)_1447.45lm@250mA_CCT=5700K_P=8.29761W_I=0.25A

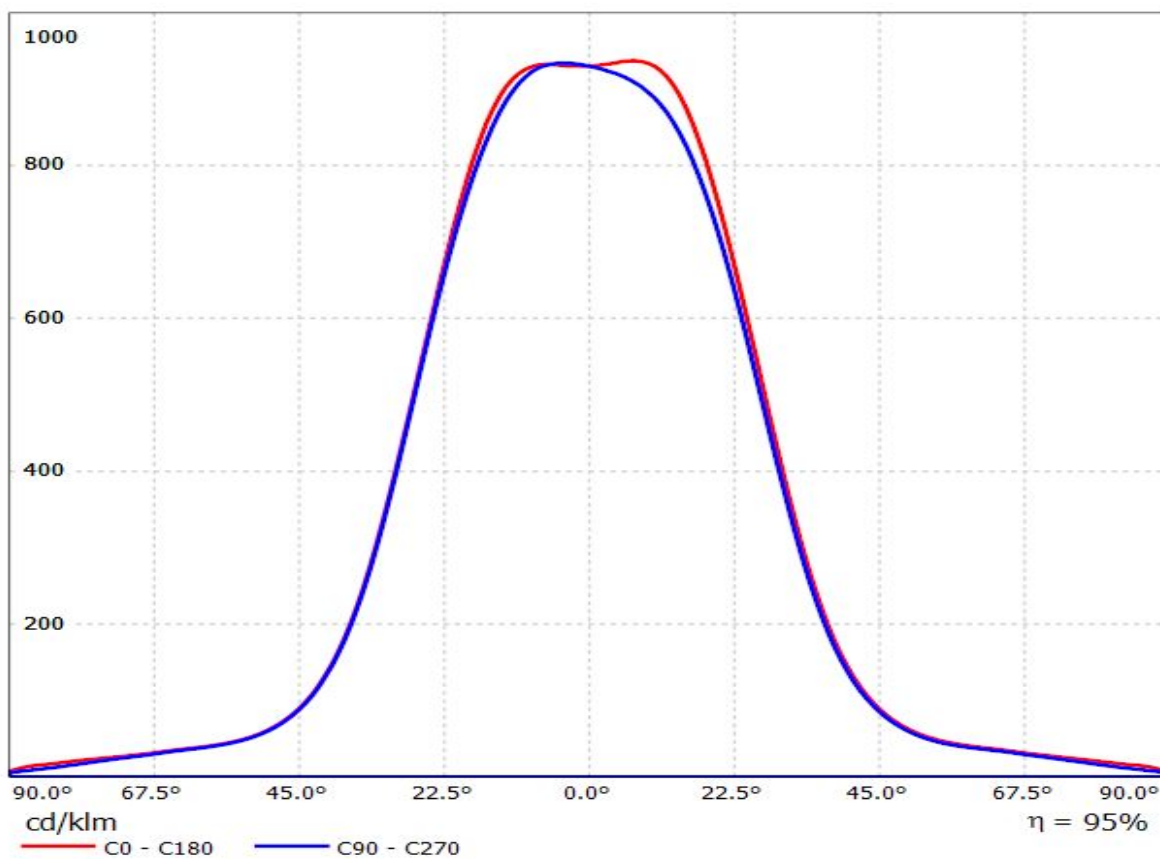

Luminaire: Ledil C14605_HB-2X2-RW_(XP-G3)

Lamps: 1 x Cree_XP-G3_2x2_(XPGDWT-B1-3C0-S4-0-01)_516.459lm@250mA_P=2.7885W_I=0.25A

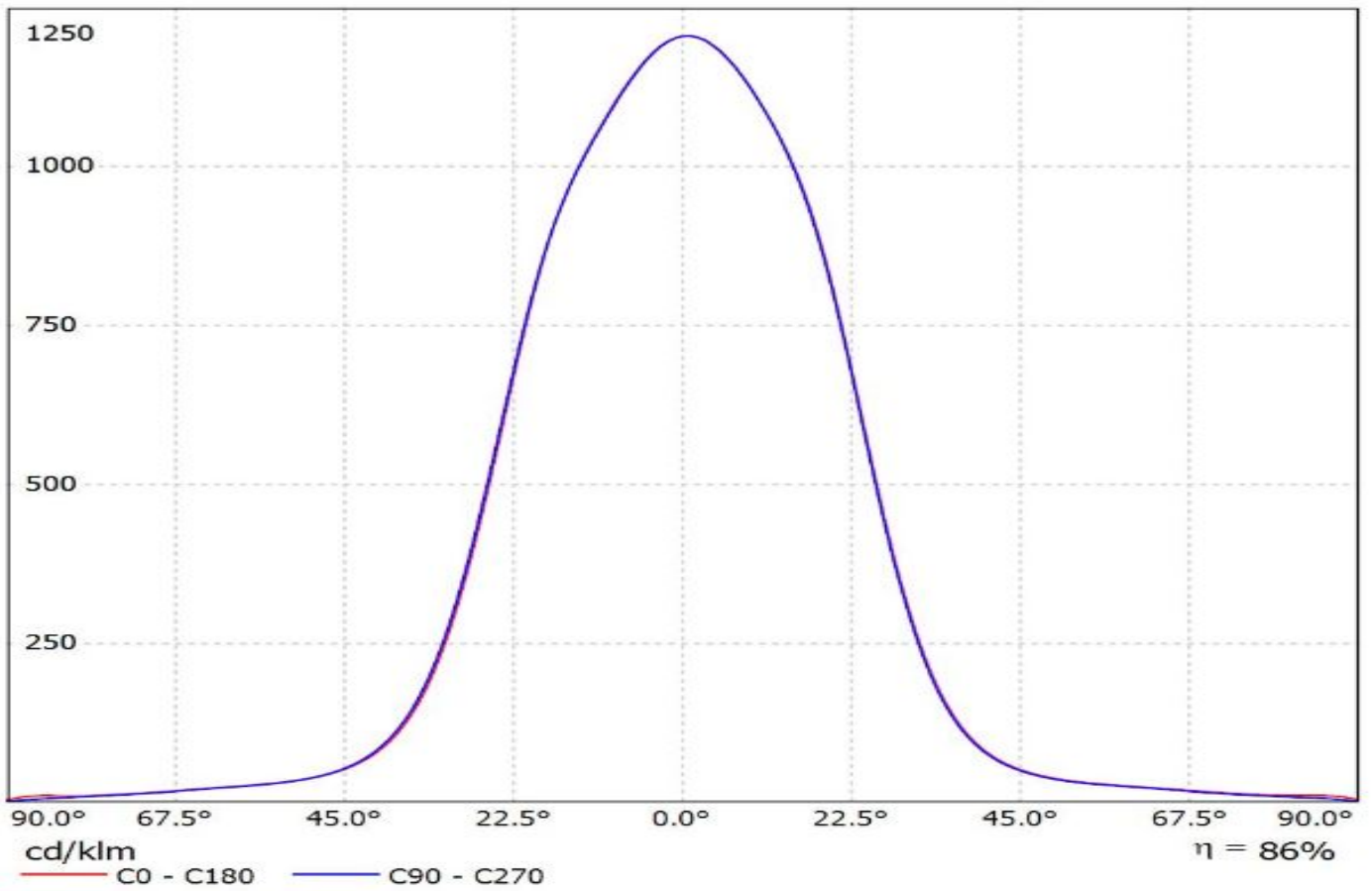

Luminaire: Ledil C14605_HB-2X2-RW_(XP-L2)

Lamps: 1 x Cree_XP-L2_2x2_(XPLBWT-00-0000-000BV50E3)550.93lm@250mA_P=2.7815W_I=0.25A

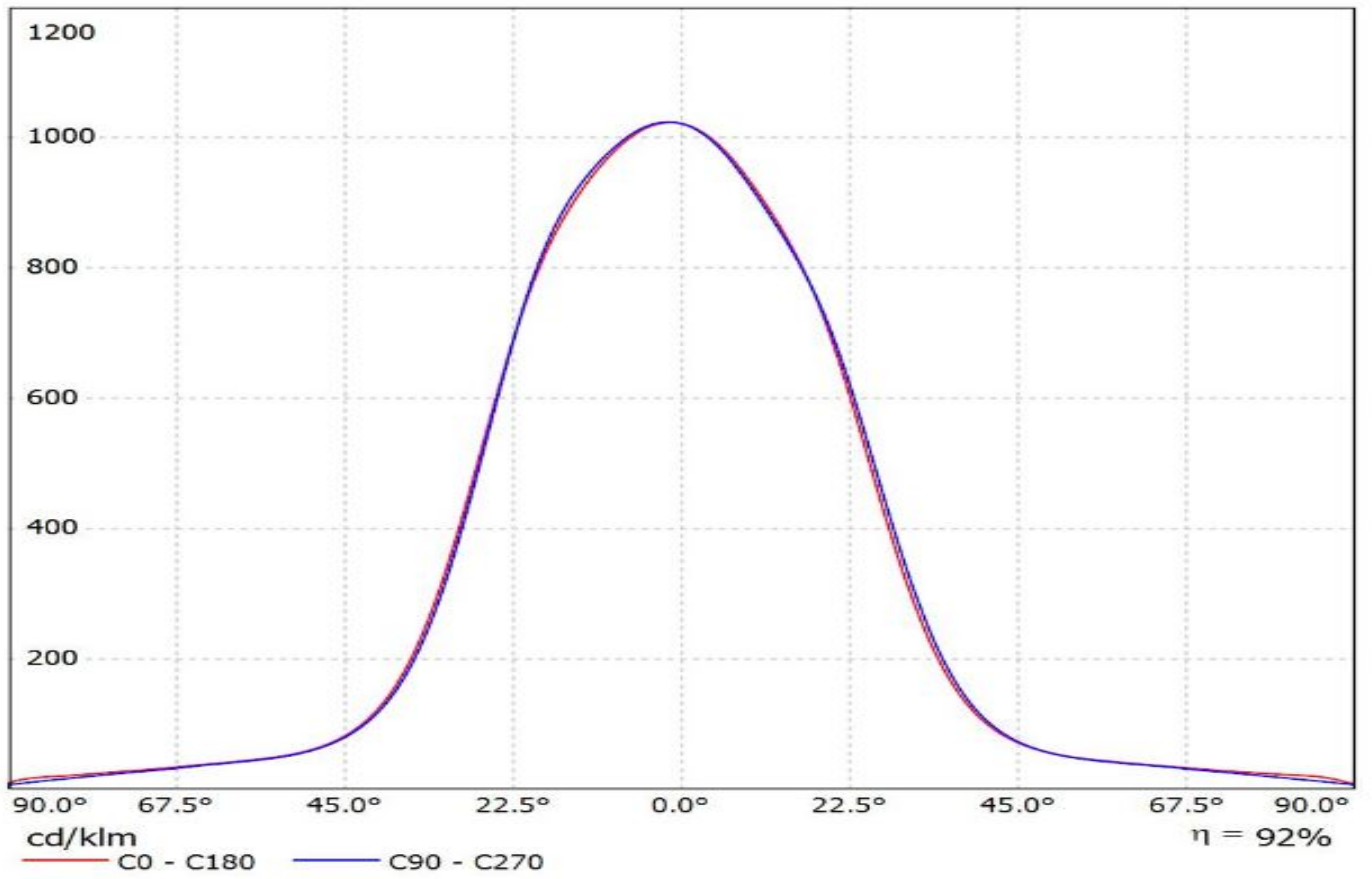

Luminaire: LEDiL Oy C14605_HB-2X2-RW_(Luxeon_5050)

Lamps: 2 x Luxeon_5050_2x2_1270.76lm@80mA_CCT=5700K_P=7.35815W_I=0.080A_70CRI

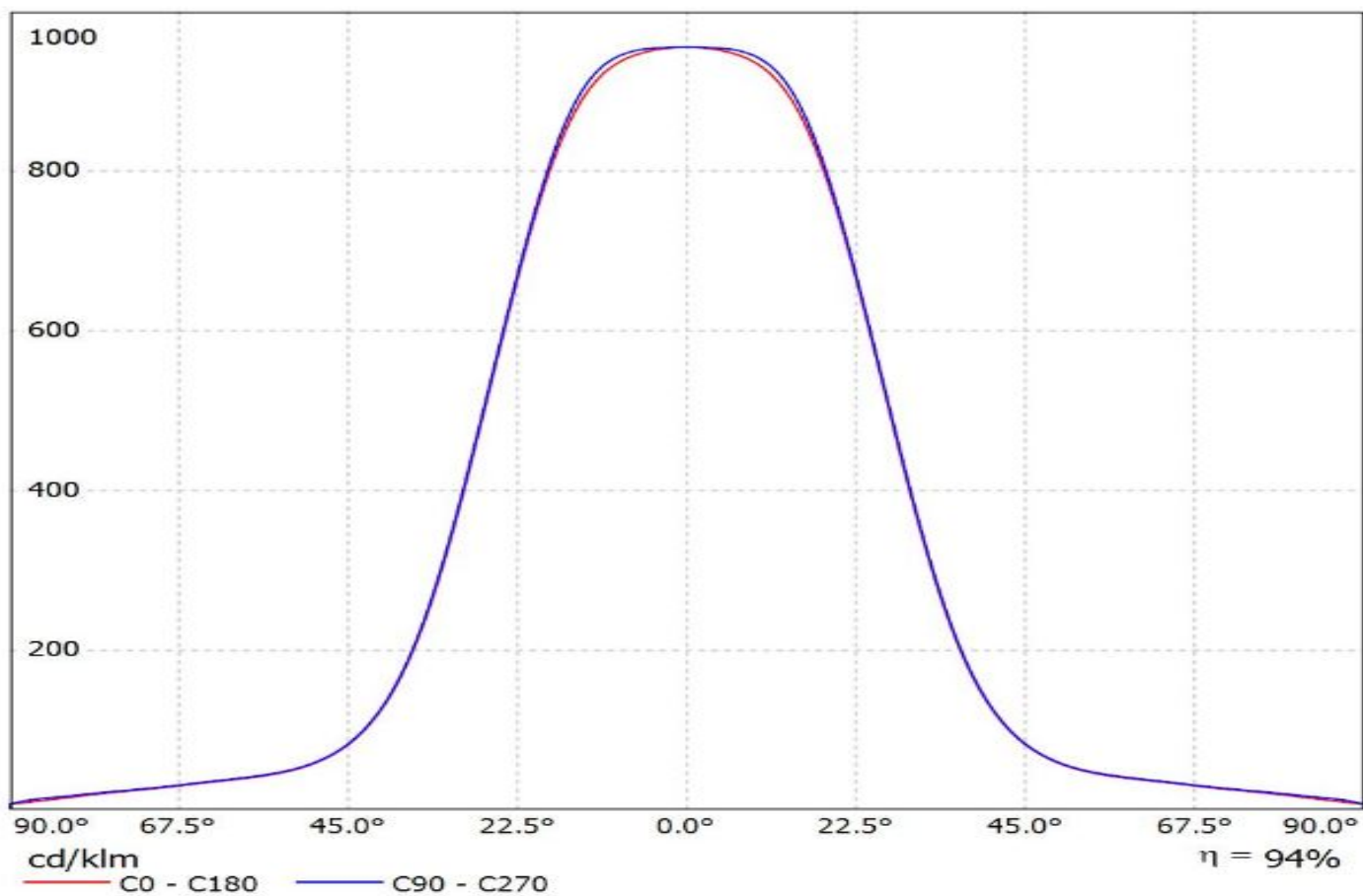

Luminaire: LEDiL Oy C14605_HB-2X2-RW_(NVSW319AE)

Lamps: 1 x Nichia_NVSW319AE_(sm405D440f2L2R70)_500.359lm@250mA_P=2.79351W_I=0.25A

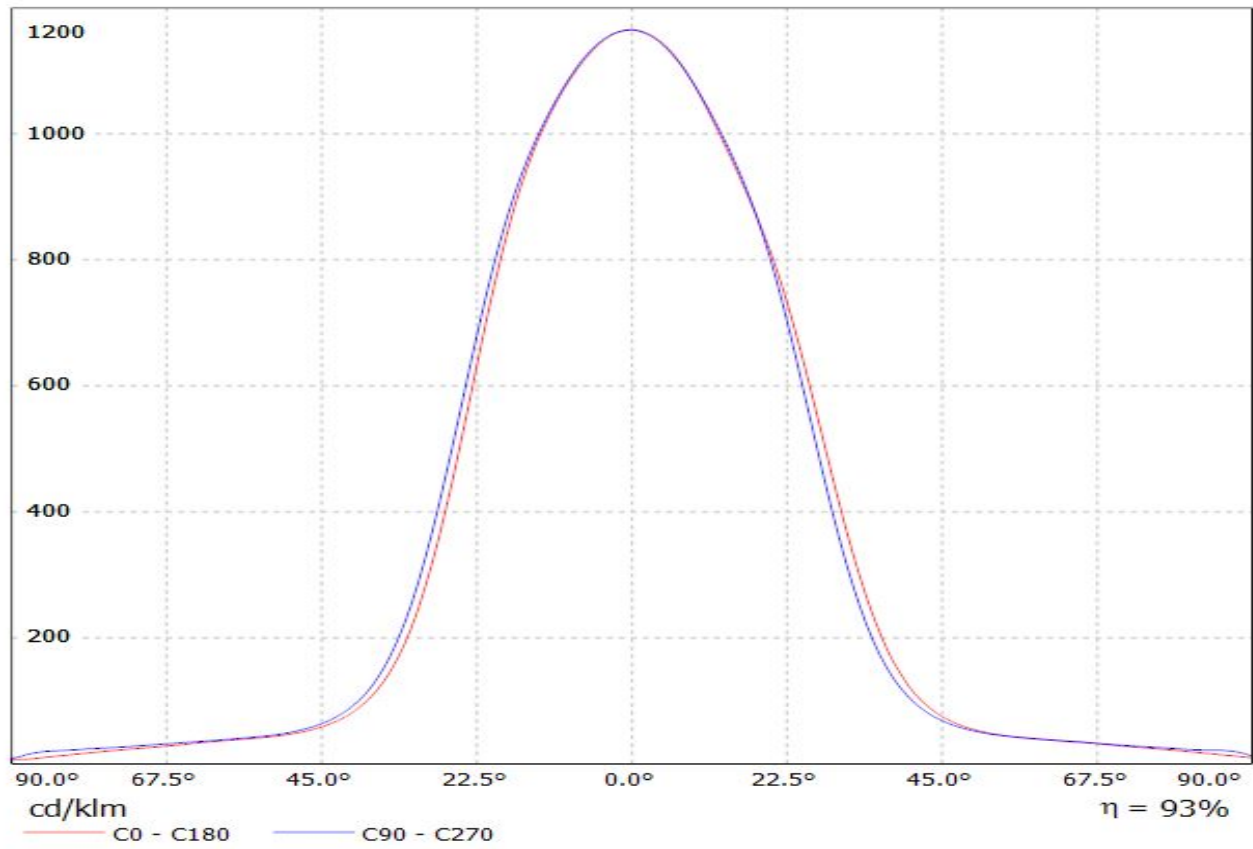

Luminaire: Ledil C14605_HB-2X2-RW_(Square_Gen3)

Lamps: 2 x Osram_Square_Gen3_(GW_CSSRM2.PM)_461.082lm@250mA_P=2.79075W_I=0.250A

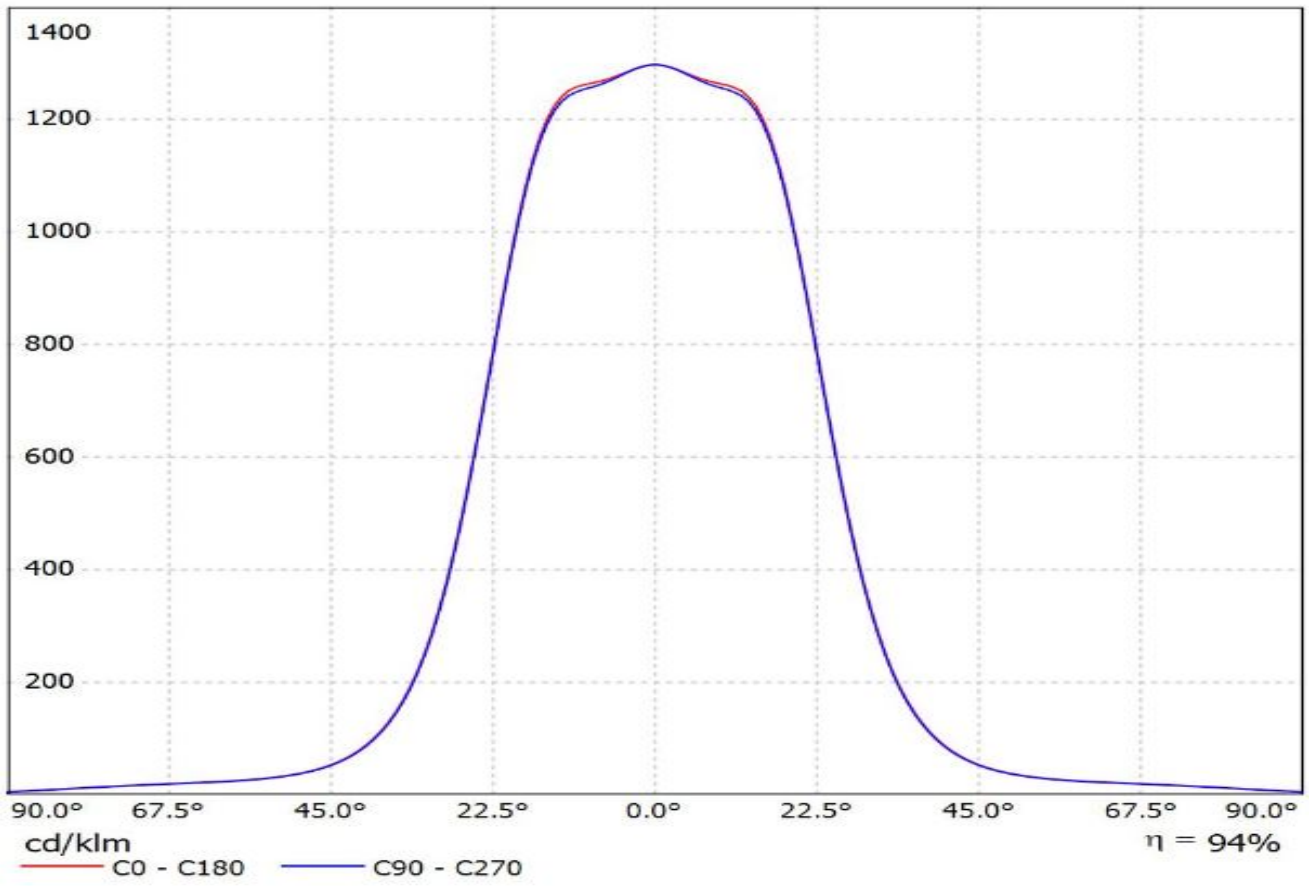

Luminaire: Ledil C14605_HB-2X2-RW_(Fortimo_FastFlex_LED_board_2x8/740_DA_G3)
Lamps: 1 x Fortimo_FastFlex_LED_board_2x8/740_DA_G3_1828.23lm@250mA_P=11.667W_I=0.25A

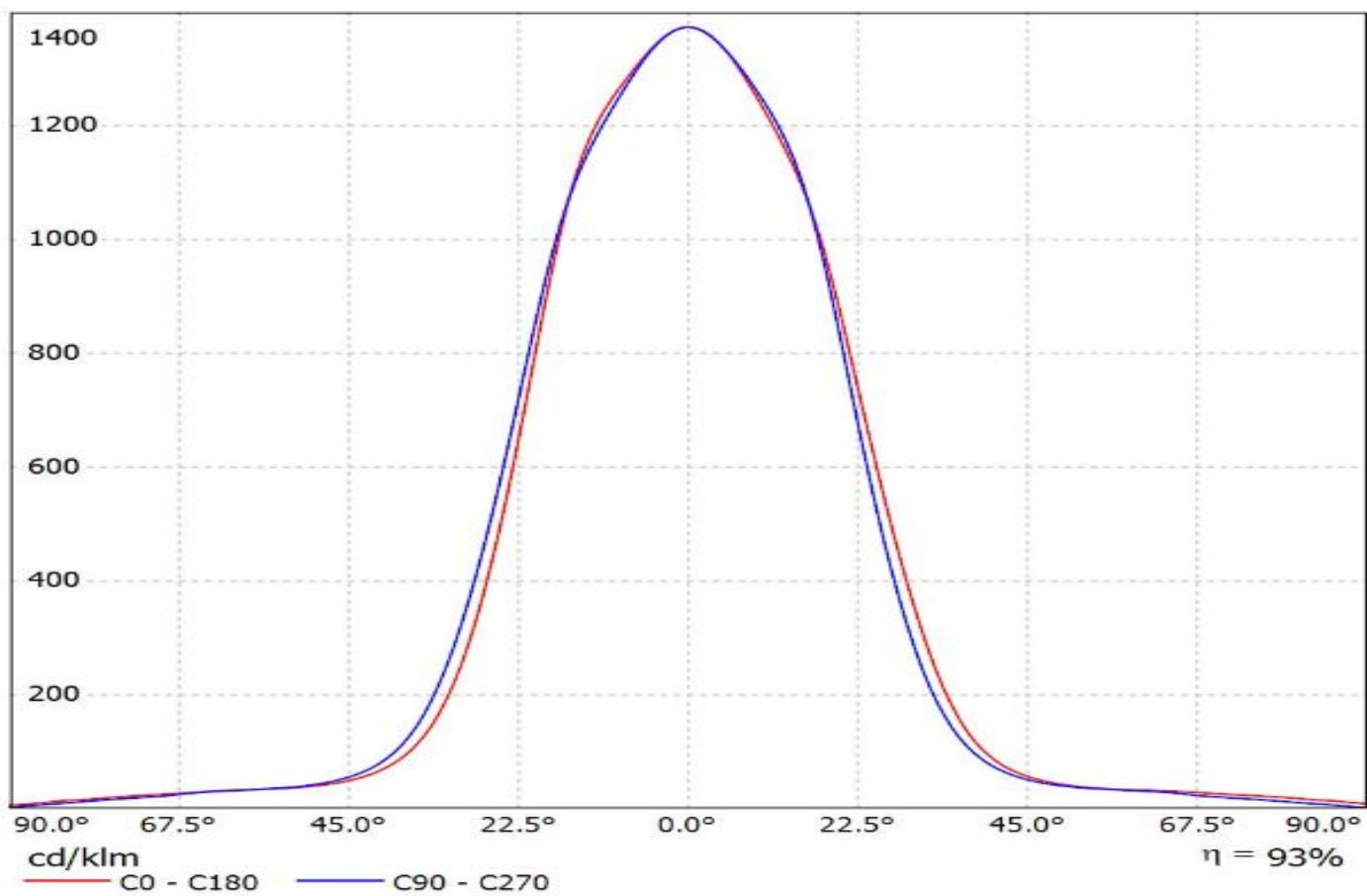

Luminaire: Ledil Oy C14605_HB-2X2-RW_(Fortimo FastFlex LED board 2x8 DAX G4)_SIMULATED
Lamps: 1 x Fortimo FastFlex LED board 2x8 DAX G4

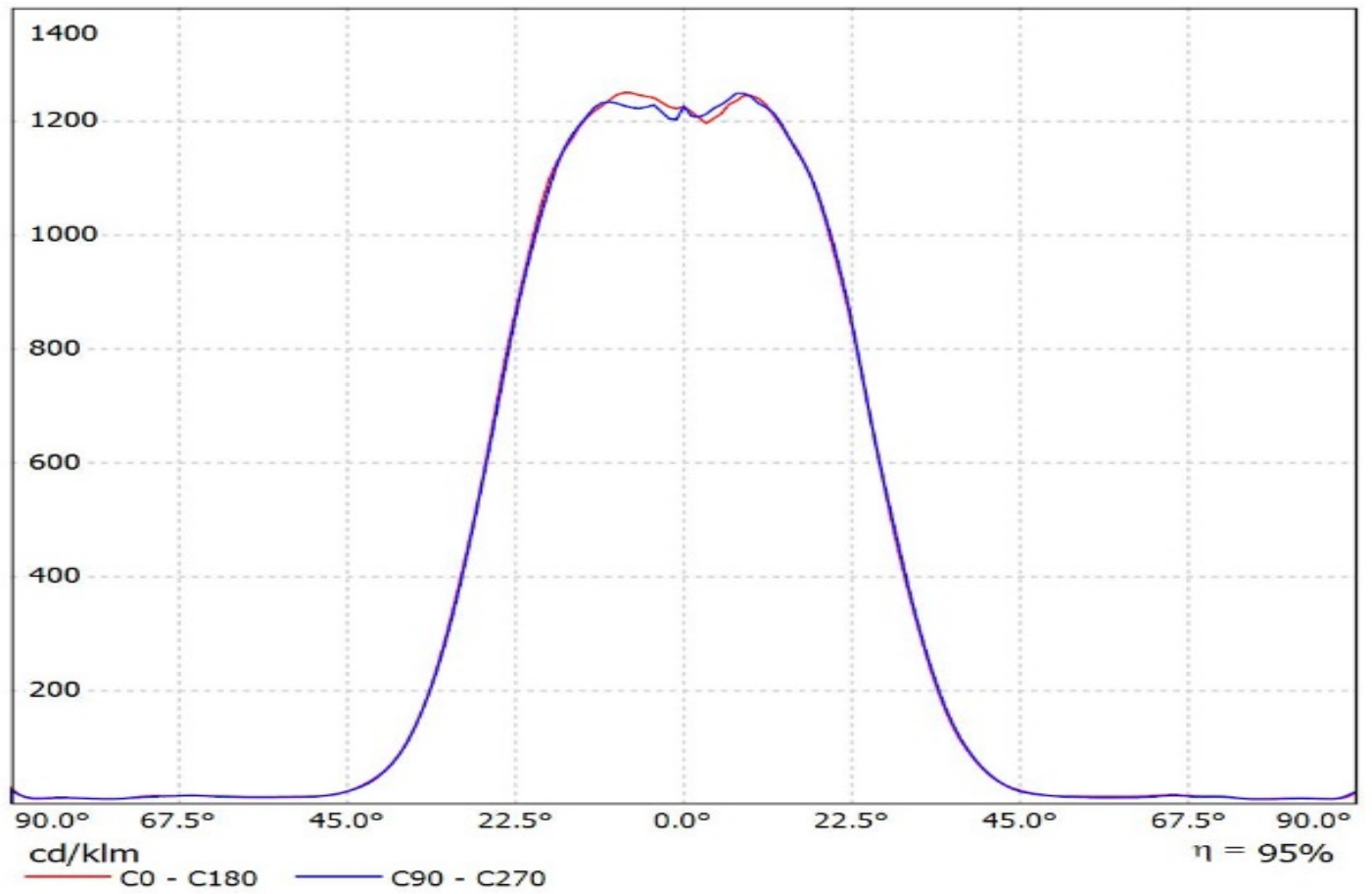

Luminaire: Ledil C14605_HB-2X2-RW_(LH351B)

Lamps: 1 x Samsung_LH351B_2x2_444.178lm@250mA_P=2.8535W_I=0.25A

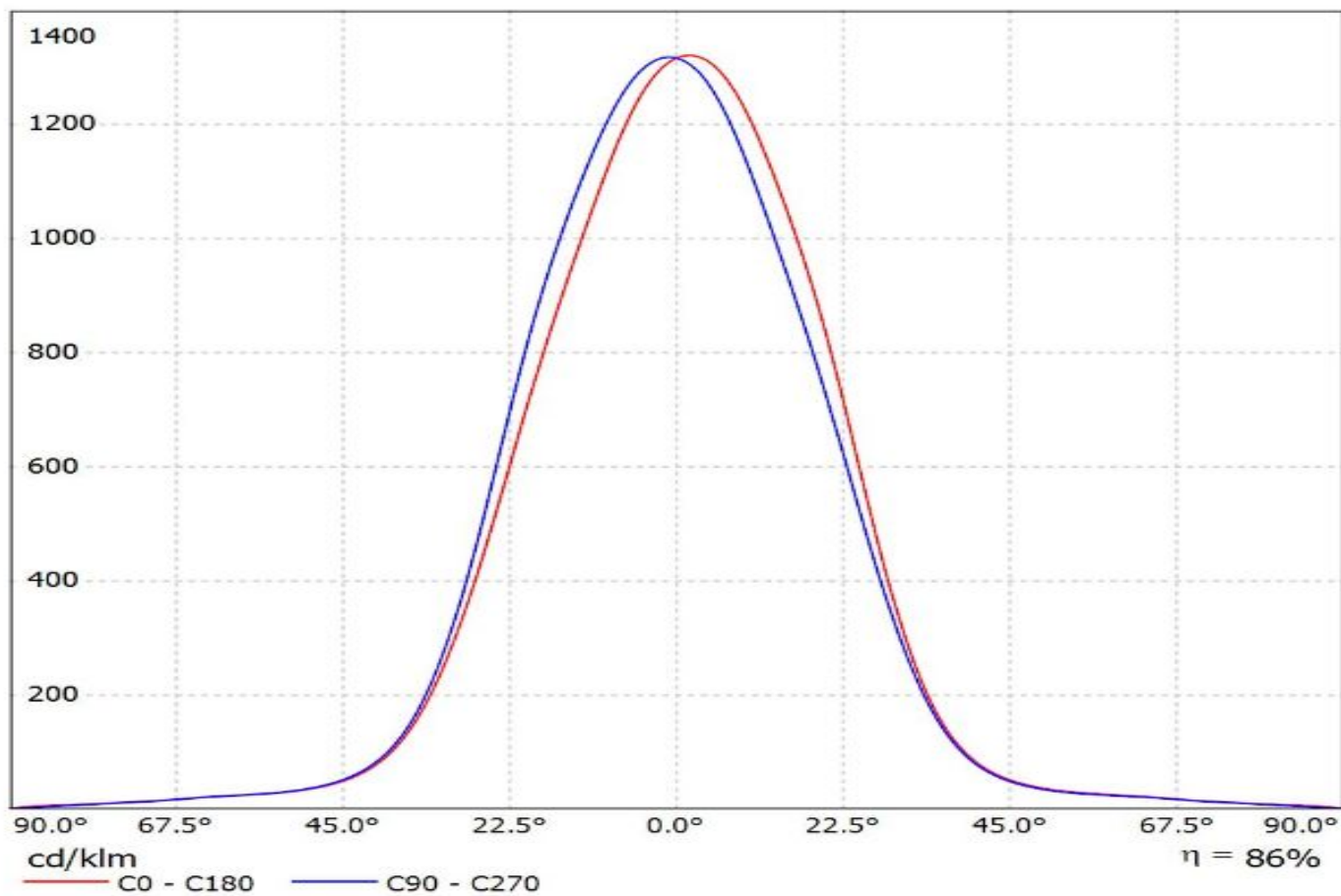

Luminaire: Ledil C14605_HB-2X2-RW_(LH351D)

Lamps: 1 x Samsung_LH351D_536.957lm@250mA_P=2.7695W_I=0.250A

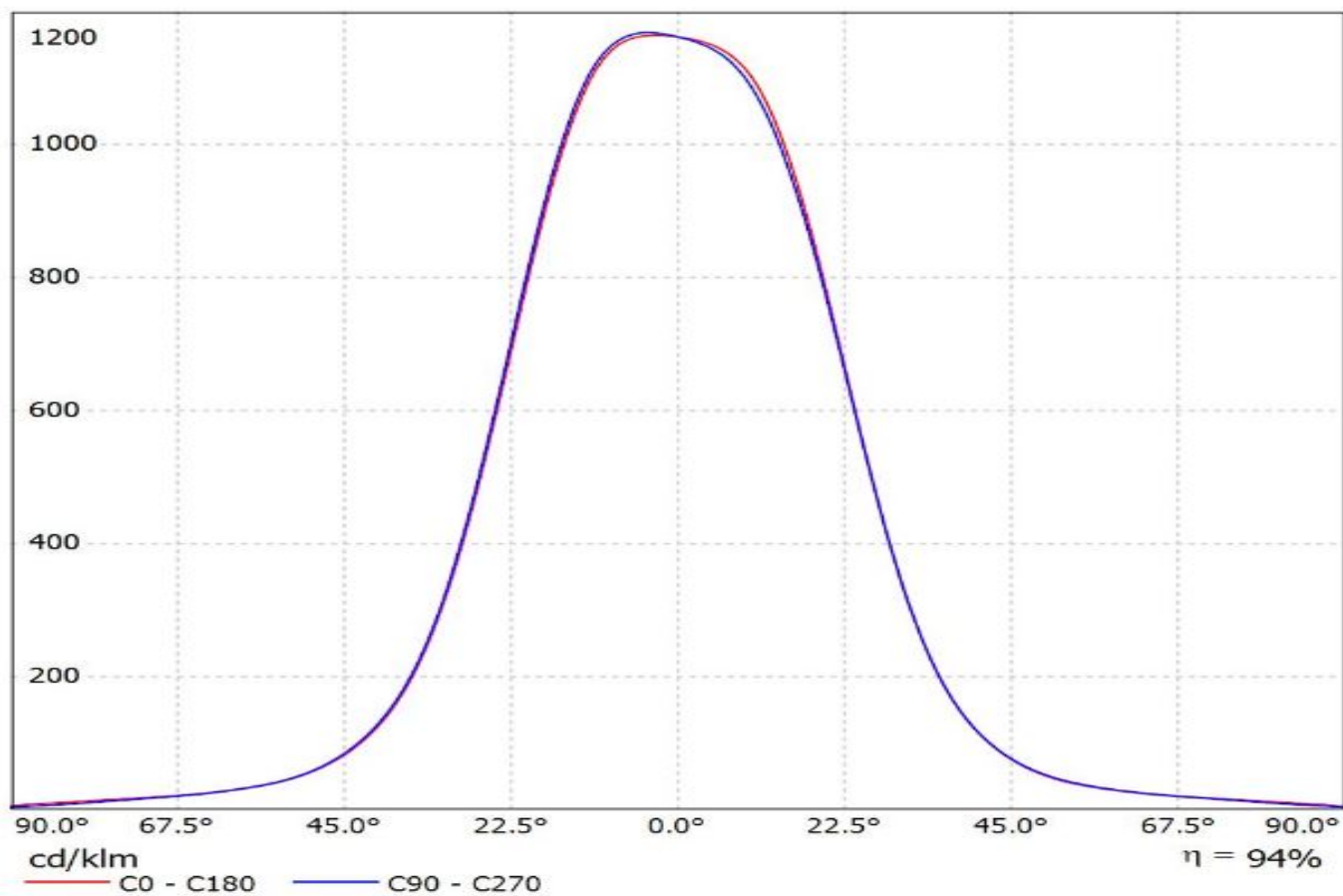

Luminaire: Ledil C14605_HB-2X2-RW_(LH508A)

Lamps: 1 x Samsung_LH508A_2x2_2060.04lm@160mA_CCT=5000K_CRI=80_P=15.5405W_I=0.16A

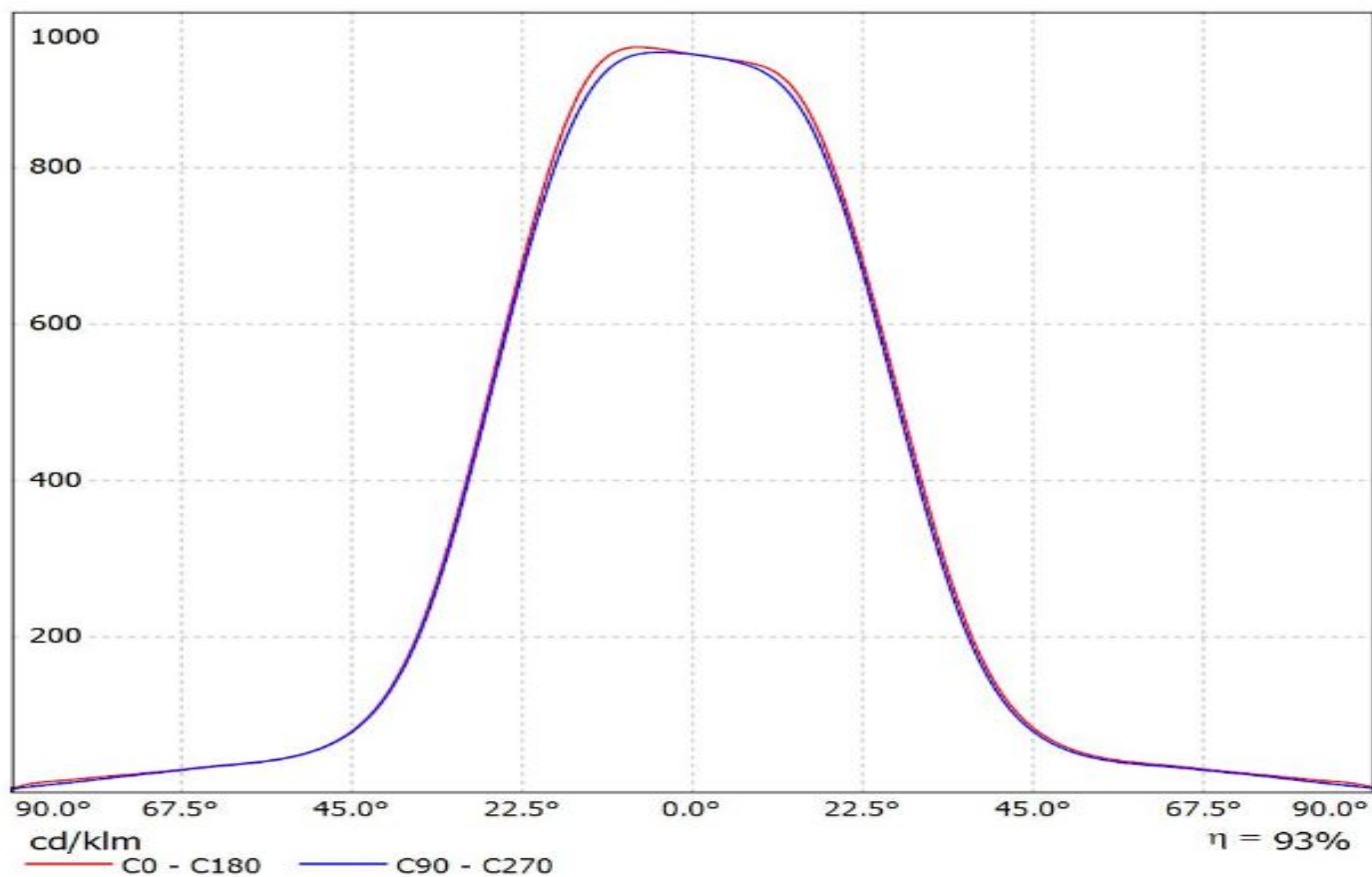

Luminaire: Ledil C14605_HB-2X2-RW_(Z8Y22plus)

Lamps: 1 x Seoul_Z8Y22plus_(W6E2G)_513.996lm@250mA_P=2.754W_I=0.250A

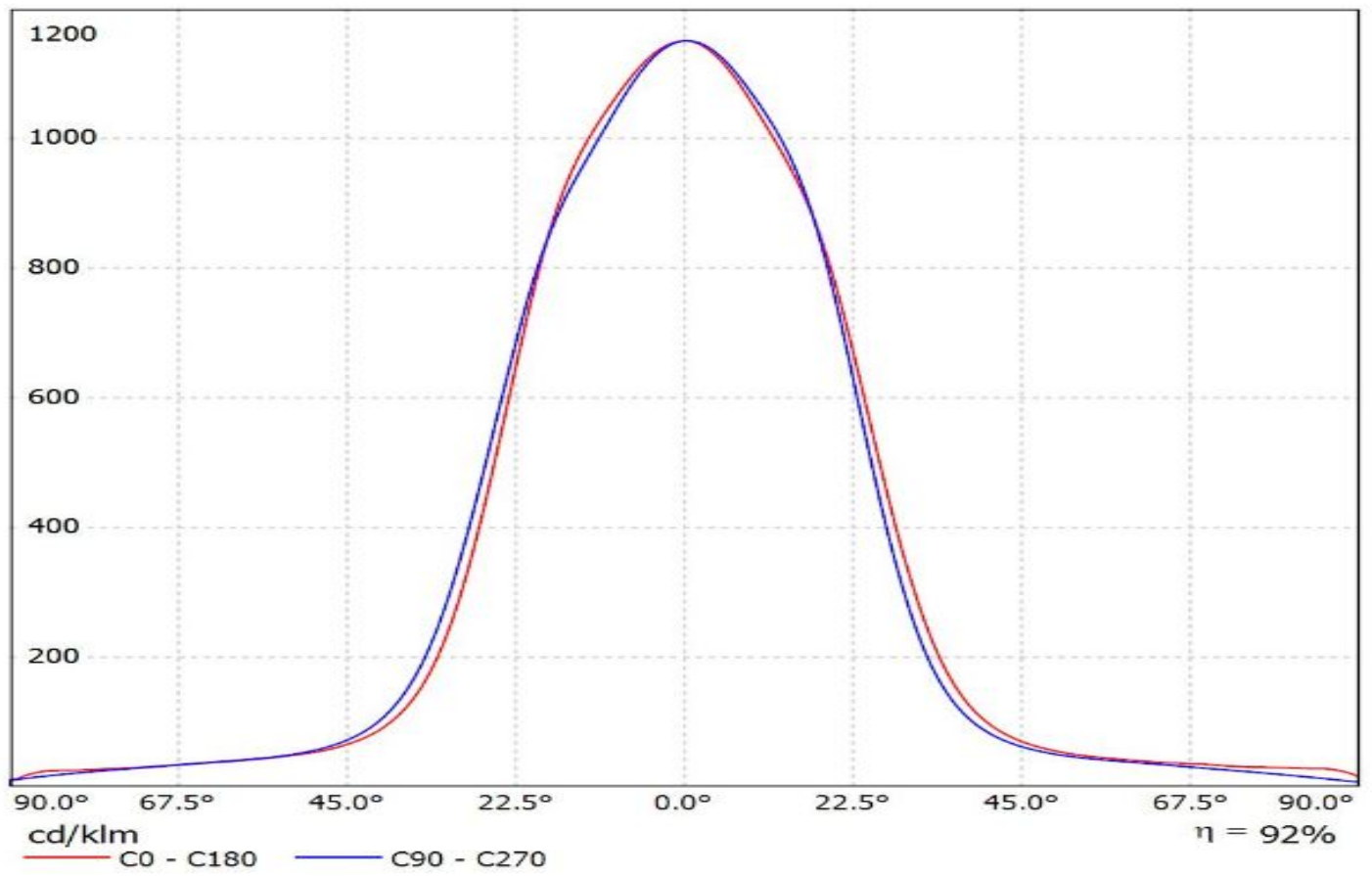

Luminaire: LEDiL Oy C14605_HB-2X2-RW_(Tridonic_Module_RLE_G1) Tridonic_Module_RLE_G1_4576.03lm@700mA_P=32.0681W_I=0.700A
Lamps: 1 x Tridonic_Module_RLE_G1_4576.03lm@700mA_P=32.0681W_I=0.700A

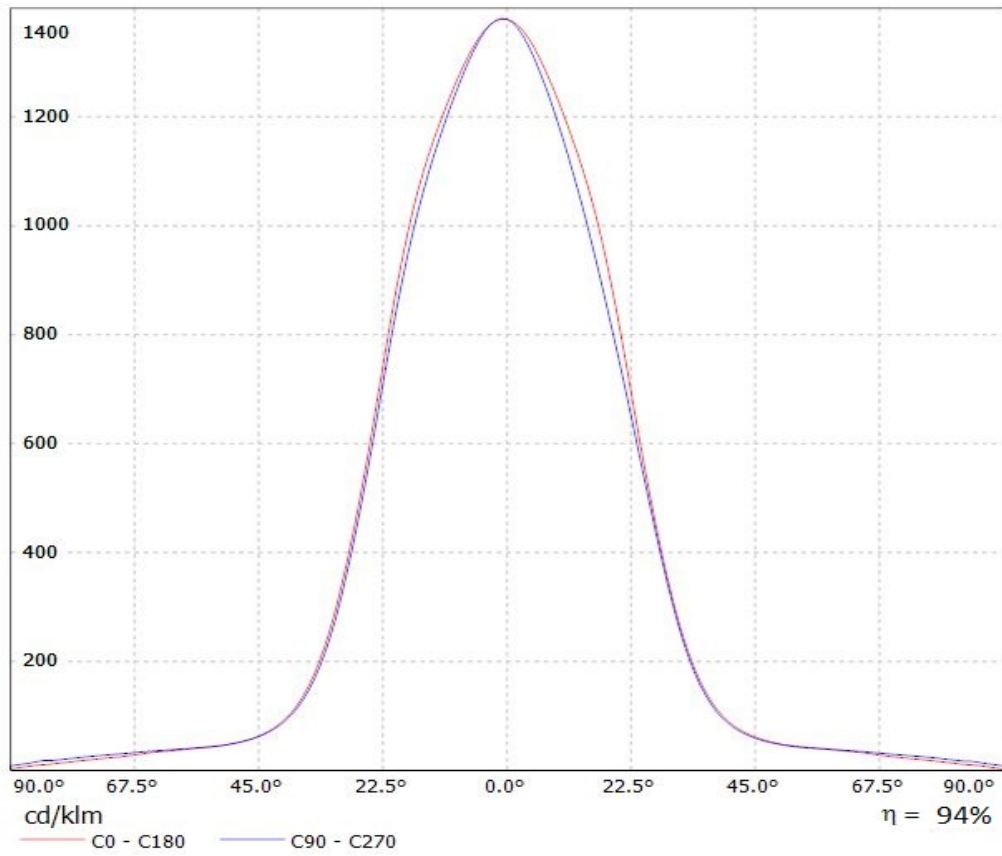

Luminaire: LEDiL Oy C14605_HB-2X2-RW_(Tridonic_Module_RLE_G1) Tridonic_Module_RLE_G1_4576.03lm@700mA_P=32.0681W_I=0.700A
Lamps: 1 x Tridonic_Module_RLE_G1_4576.03lm@700mA_P=32.0681W_I=0.700A

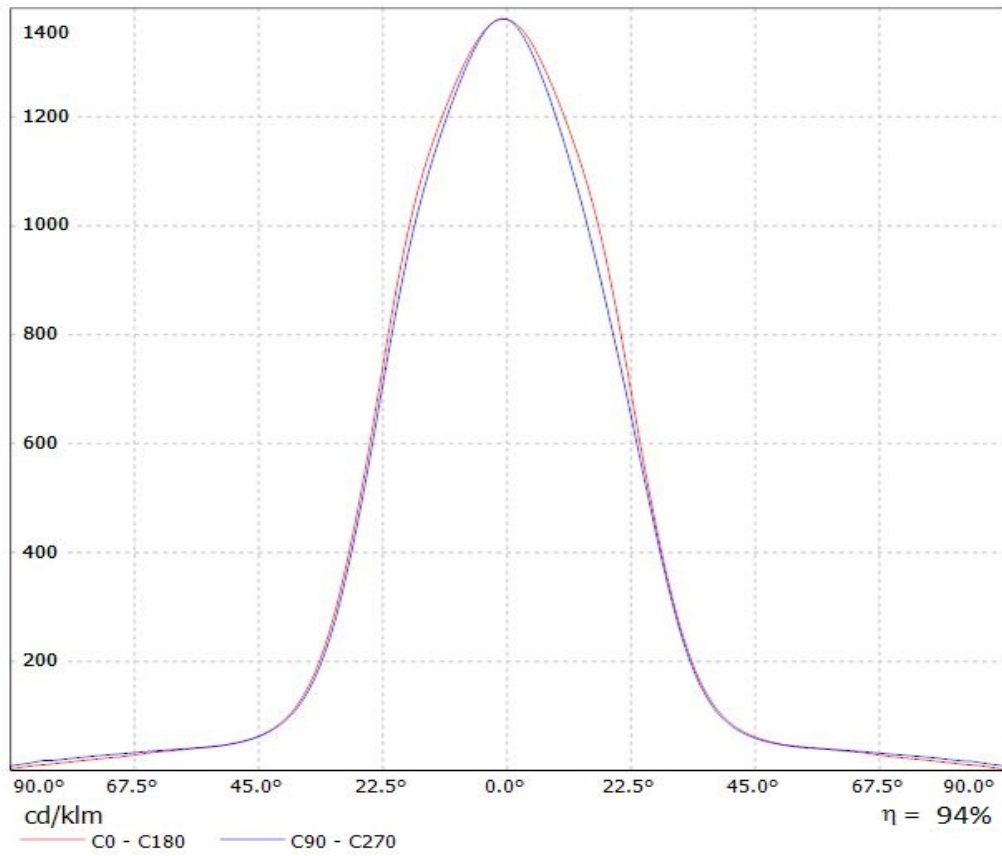

Luminaire: LEDiL Oy C14605_HB-2X2-RW_(Tridonic_Module_RLE_G1)
Lamps: 1 x Tridonic_Module_RLE_G1_2288lm@700mA_P=16W_I=0.700A

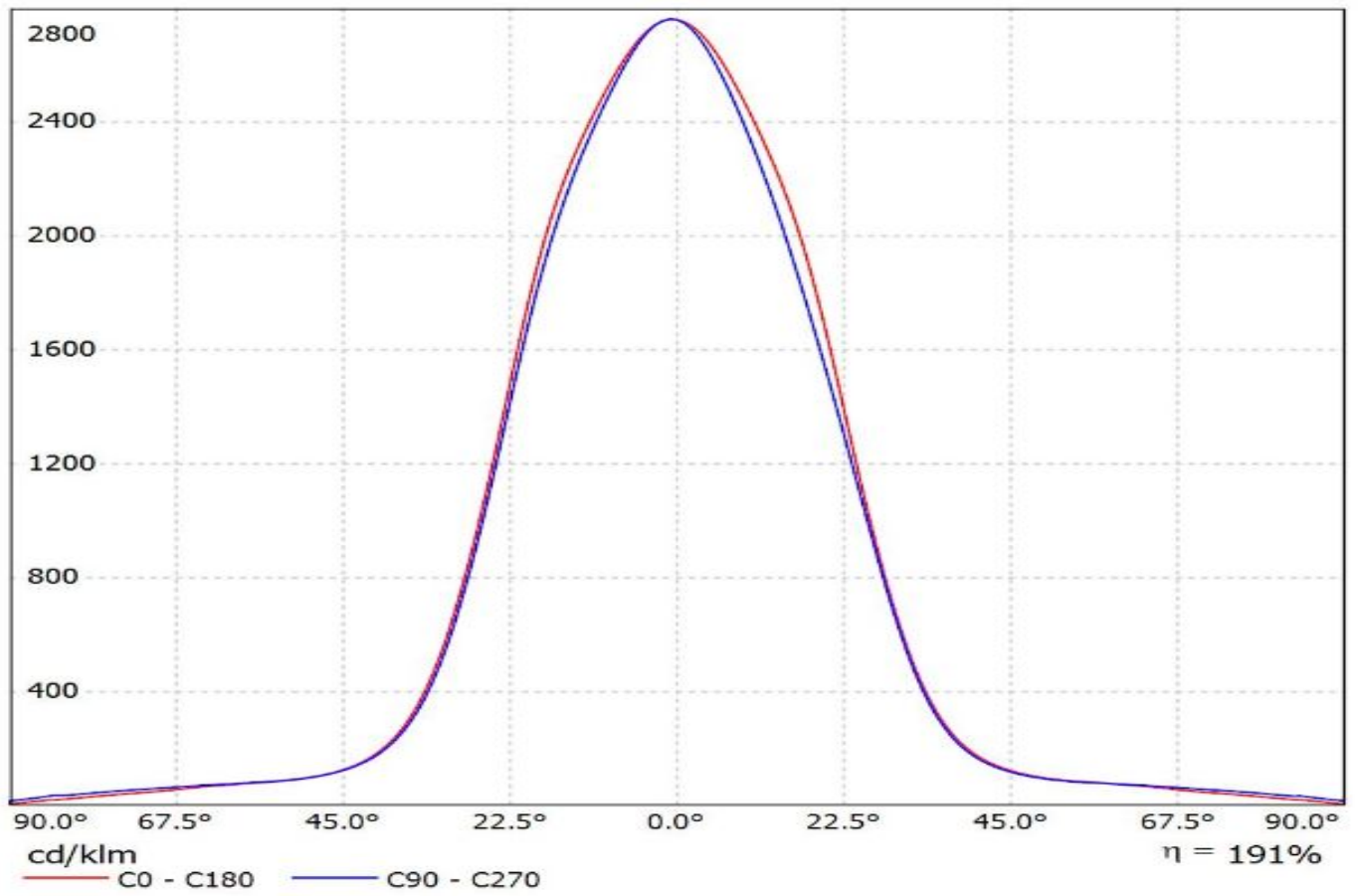

Luminaire: LEDiL Oy C14605_HB-2X2-RW_(Tridonic_Module_RLE_G1)
Lamps: 1 x Tridonic_Module_RLE_G1_2288lm@700mA_P=16W_I=0.700A

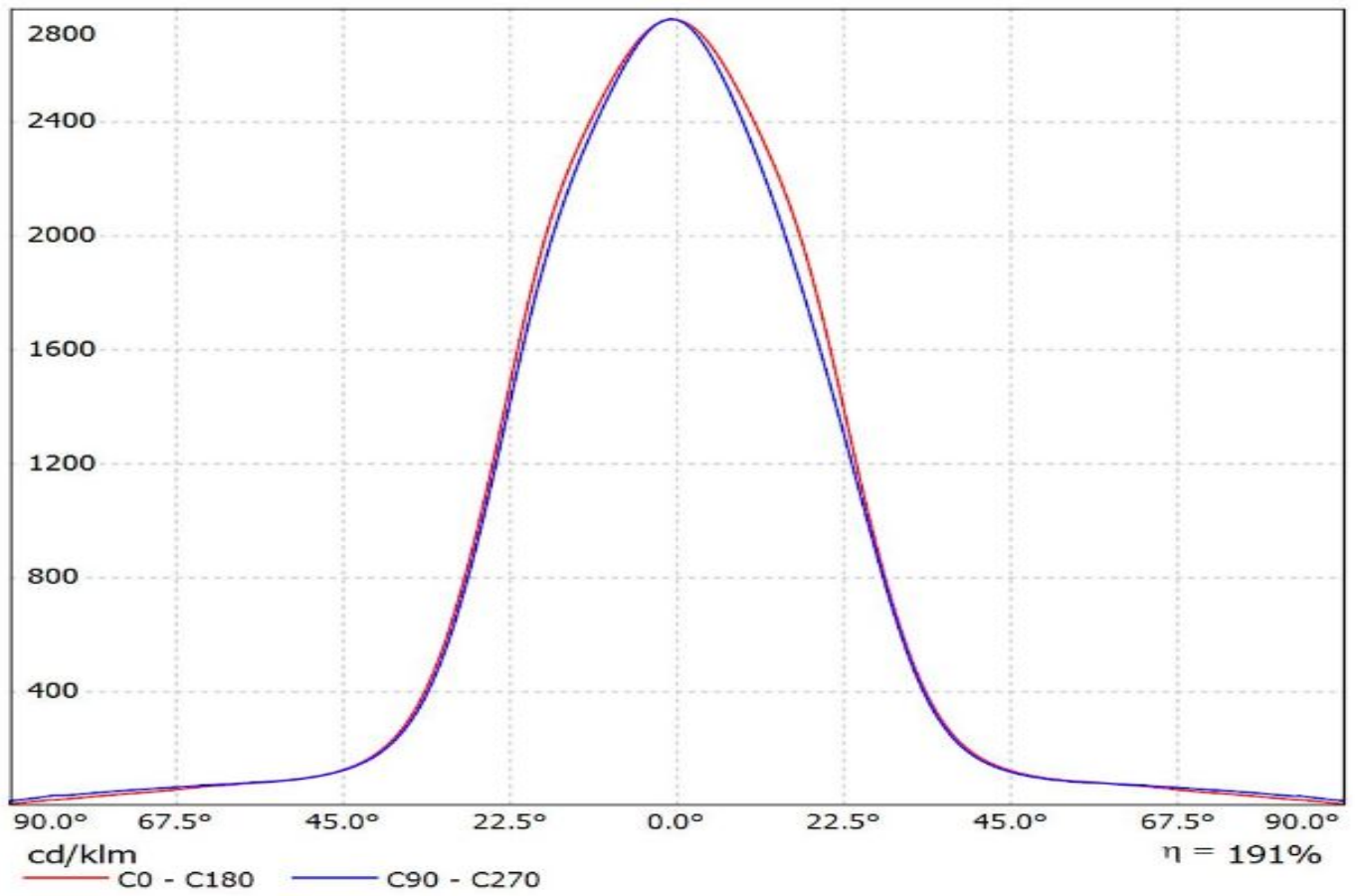

Luminaire: LEDiL Oy C14605_HB-2X2-RW_(Bridgelux_5050_Gen2)

Lamps: 1 x Bridgelux_5050_Gen2_2x2_(BXEP-57C-435-09B)_1447.45lm@250mA_CCT=5700K_P=8.29761W_I=0.25A

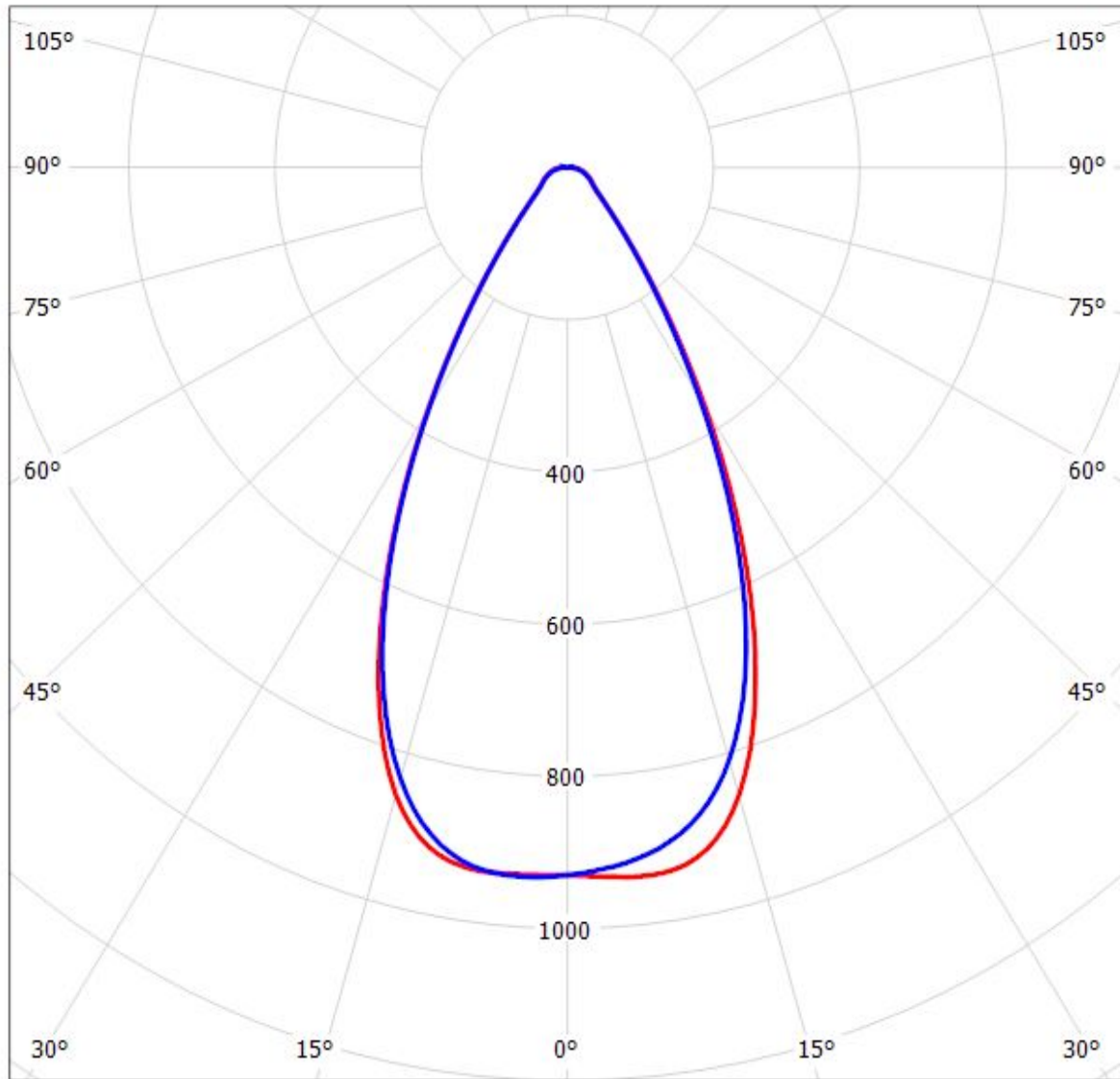

cd/klm

— C0 - C180

— C90 - C270

$\eta = 95\%$

Luminaire: Ledil C14605_HB-2X2-RW_(XP-G3)

Lamps: 1 x Cree_XP-G3_2x2_(XPGDWT-B1-3C0-S4-0-01)_516.459lm@250mA_P=2.7885W_I=0.25A

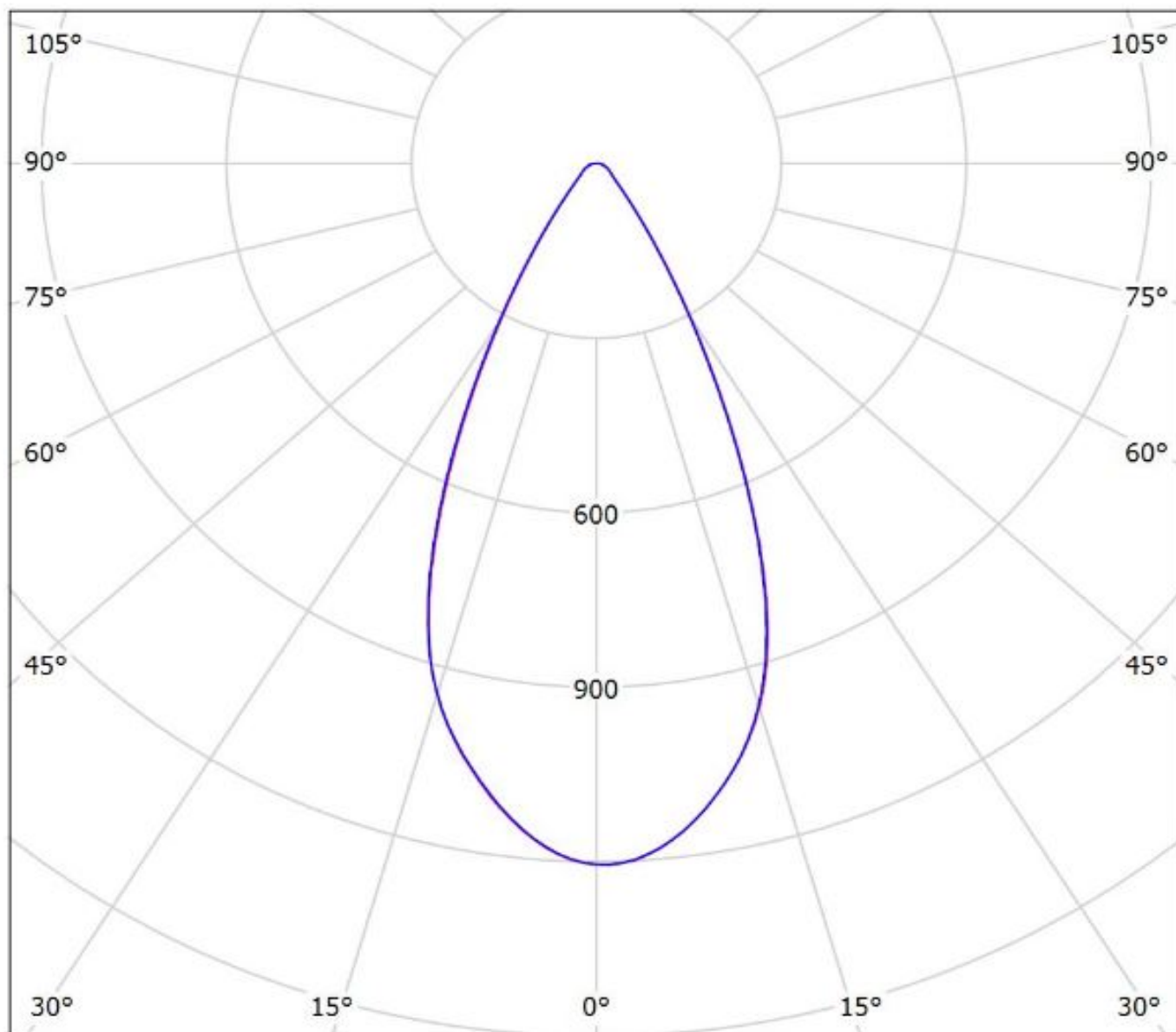

cd/klm

— C0 - C180

— C90 - C270

η = 86%

Luminaire: Ledil C14605_HB-2X2-RW_(XP-L2)

Lamps: 1 x Cree_XP-L2_2x2_(XPLBWT-00-0000-000BV50E3)550.93lm@250mA_P=2.7815W_I=0.25A

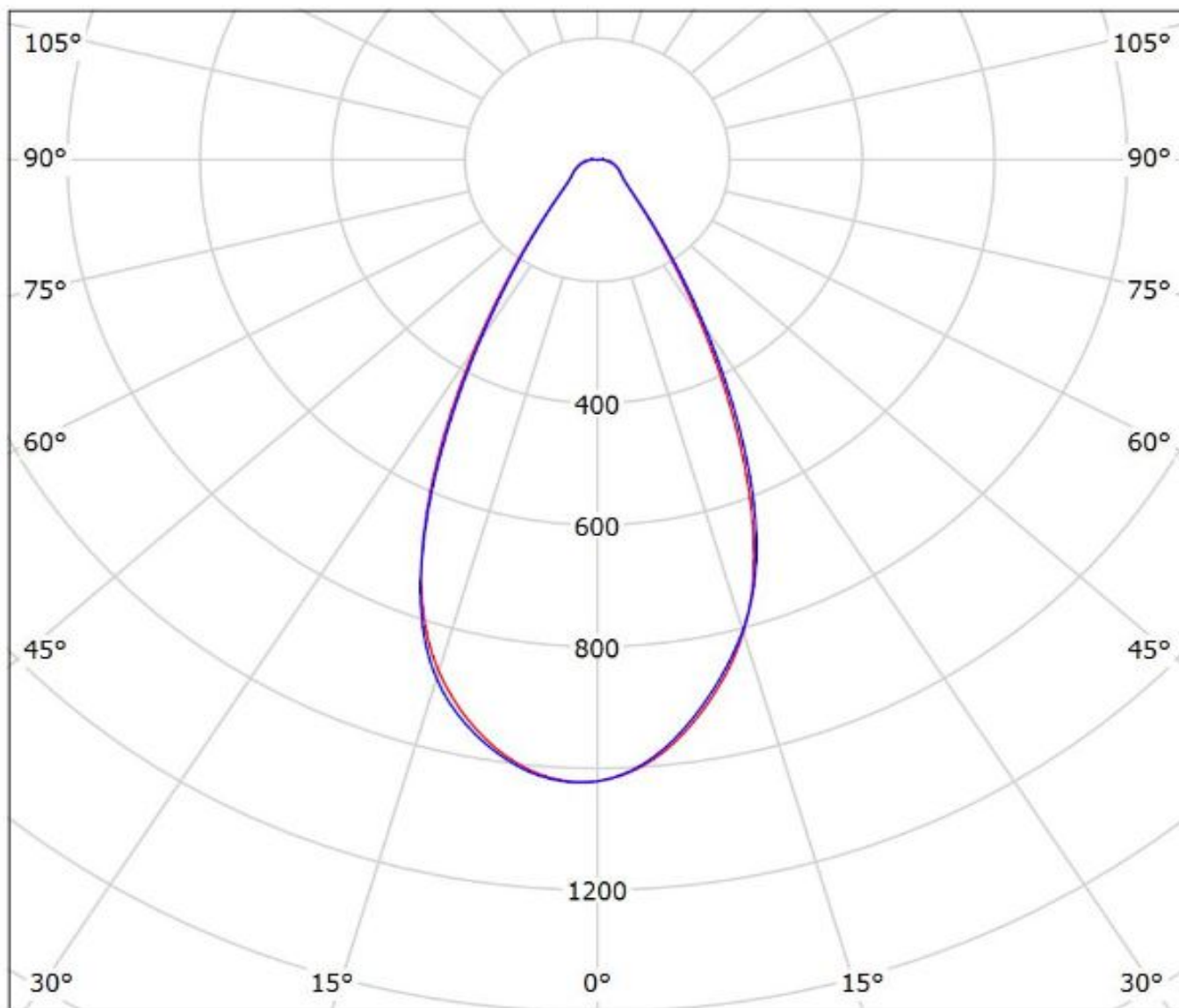

cd/klm

— C0 - C180 — C90 - C270

$\eta = 92\%$

Luminaire: LEDiL Oy C14605_HB-2X2-RW_(Luxeon_5050)

Lamps: 2 x Luxeon_5050_2x2_1270.76lm@80mA_CCT=5700K_P=7.35815W_I=0.080A_70CRI

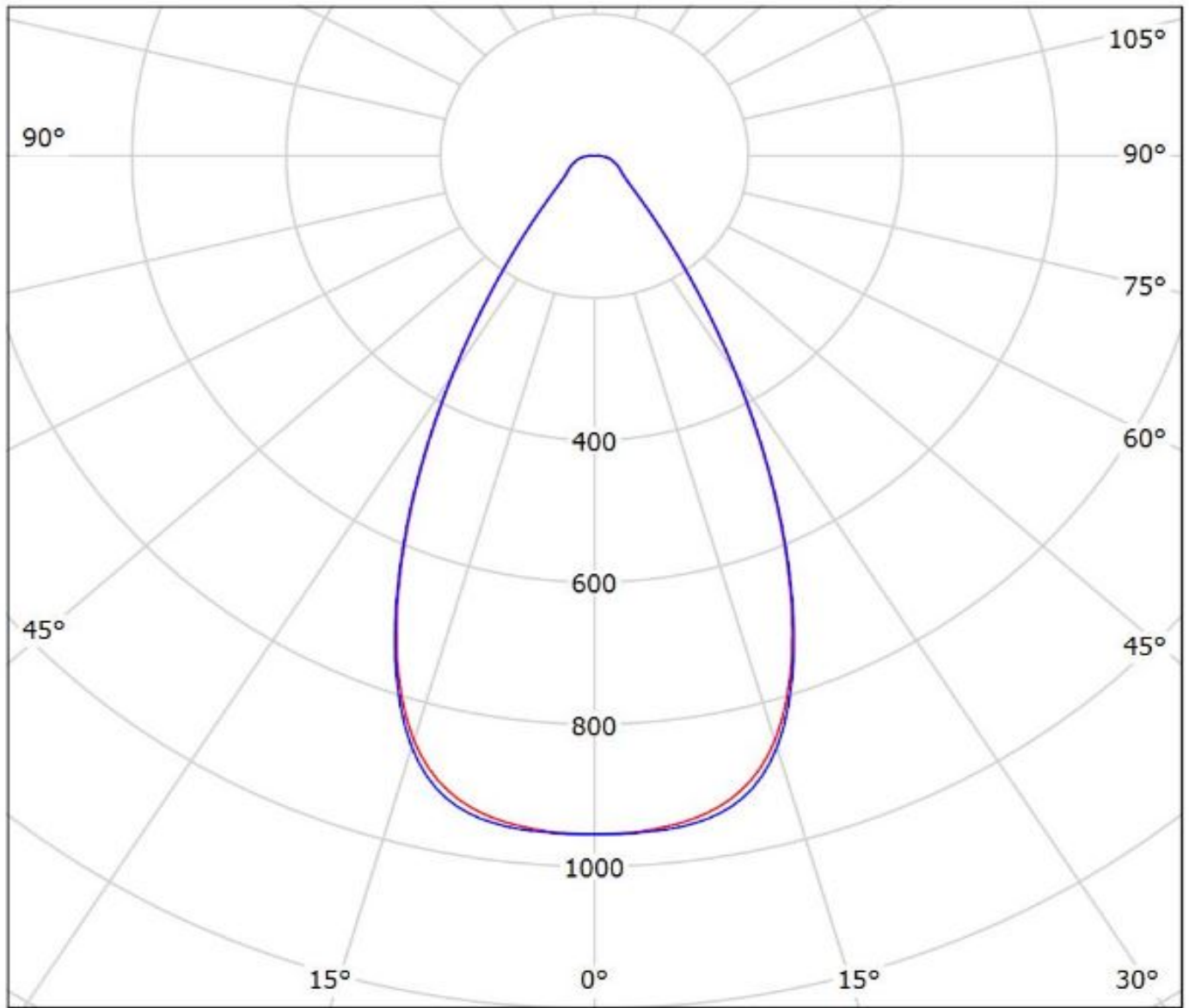

cd/klm

— C0 - C180

— C90 - C270

$\eta = 94\%$

Luminaire: LEDiL Oy C14605_HB-2X2-RW_(NVSW319AE)

Lamps: 1 x Nichia_NVSW319AE_(sm405D440f2L2R70)_500.359lm@250mA_P=2.79351W_I=0.25A

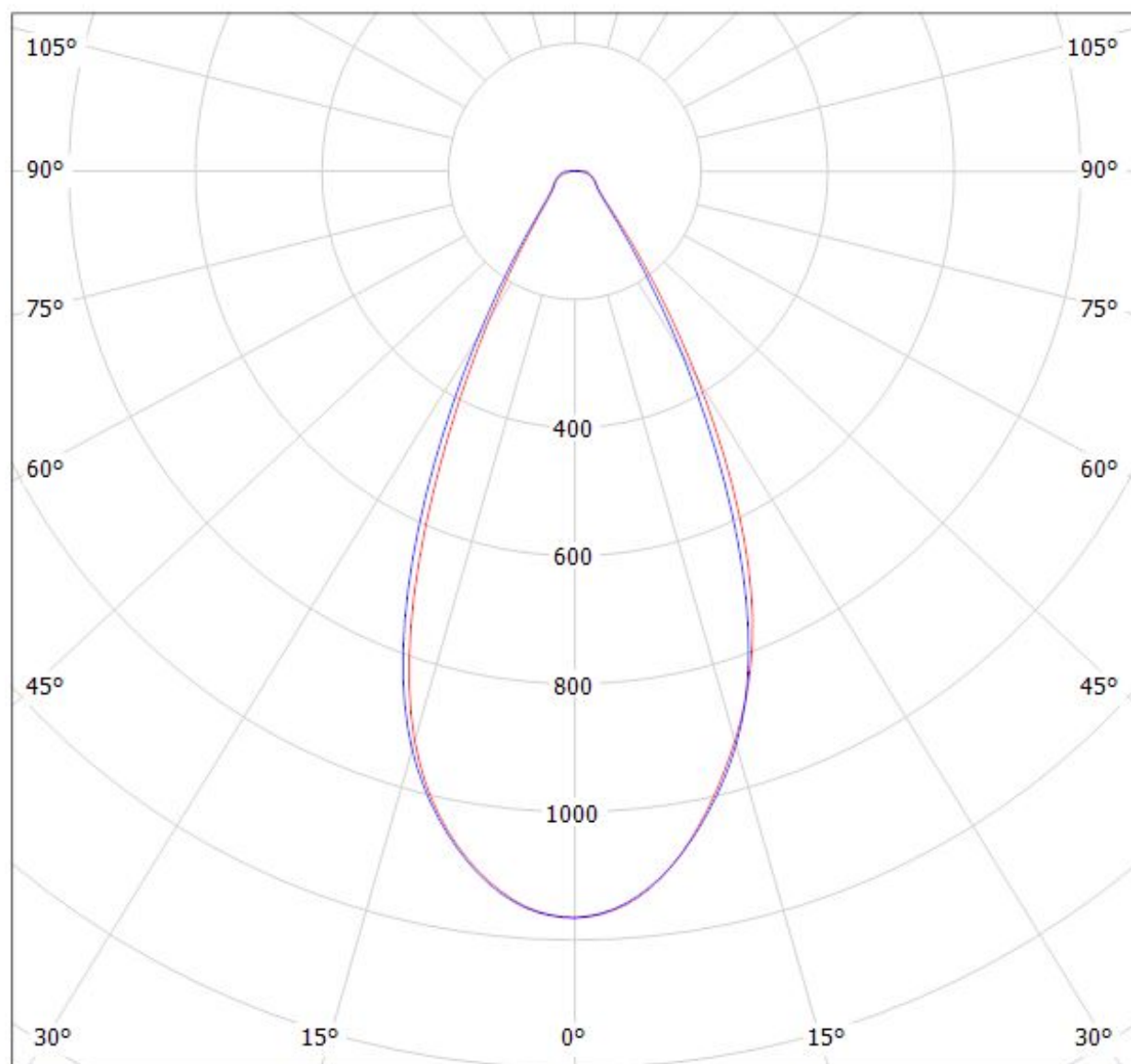

cd/klm

— C0 - C180

— C90 - C270

$\eta = 93\%$

Luminaire: Ledil C14605_HB-2X2-RW_(Square_Gen3)

Lamps: 2 x Osram_Square_Gen3_(GW_CSSRM2.PM)_461.082lm@250mA_P=2.79075W_I=0.250A

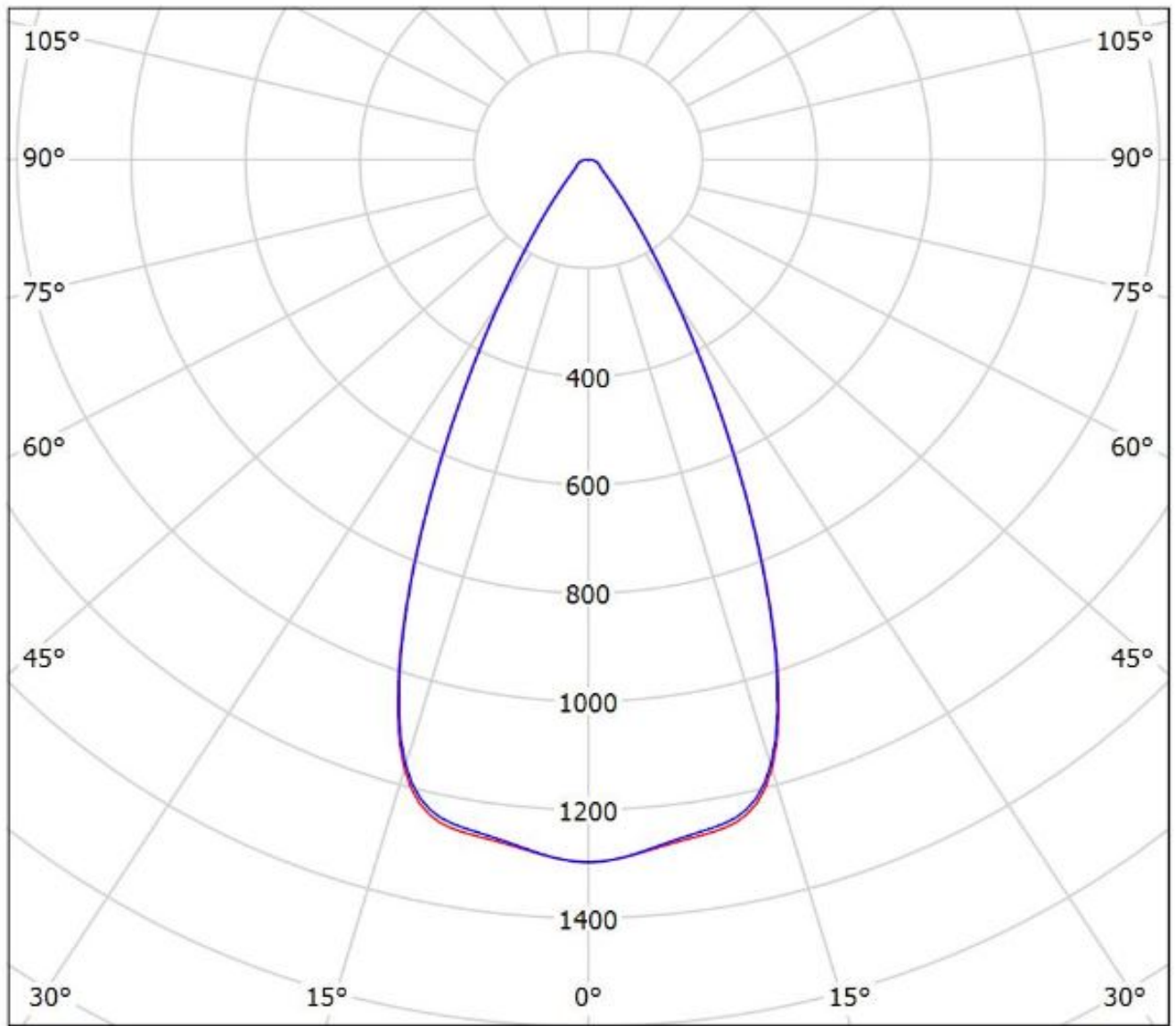

cd/klm

— C0 - C180 — C90 - C270

$\eta = 94\%$

Luminaire: Ledil C14605_HB-2X2-RW_(Fortimo_FastFlex_LED_board_2x8/740_DA_G3)
Lamps: 1 x Fortimo_FastFlex_LED_board_2x8/740_DA_G3_1828.23lm@250mA_P=11.667W_I=0.25A

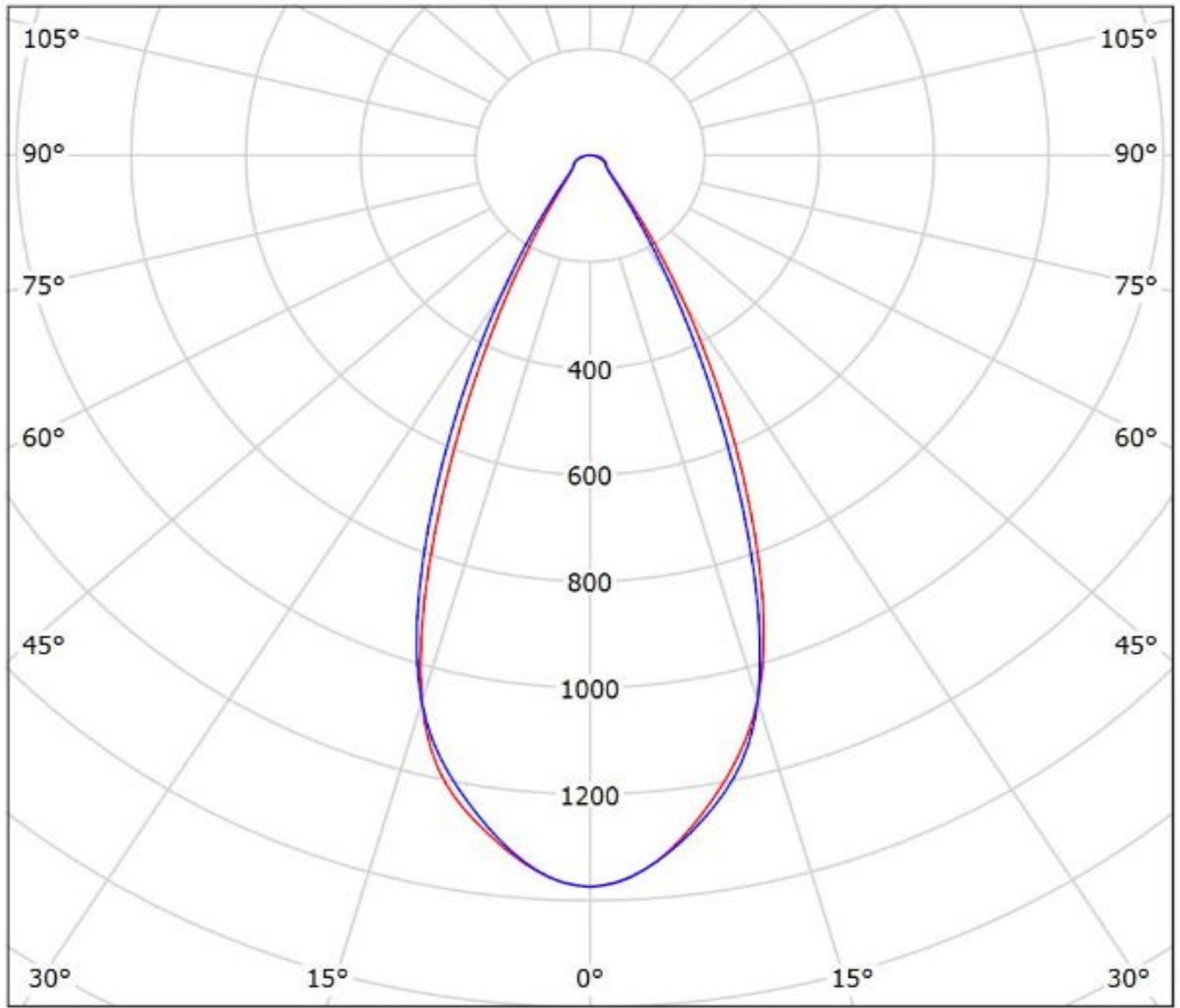

cd/klm

— C0 - C180 — C90 - C270

$\eta = 93\%$

Luminaire: Ledil Oy C14605_HB-2X2-RW_(Fortimo FastFlex LED board 2x8 DAX G4)_SIMULATED
Lamps: 1 x Fortimo FastFlex LED board 2x8 DAX G4

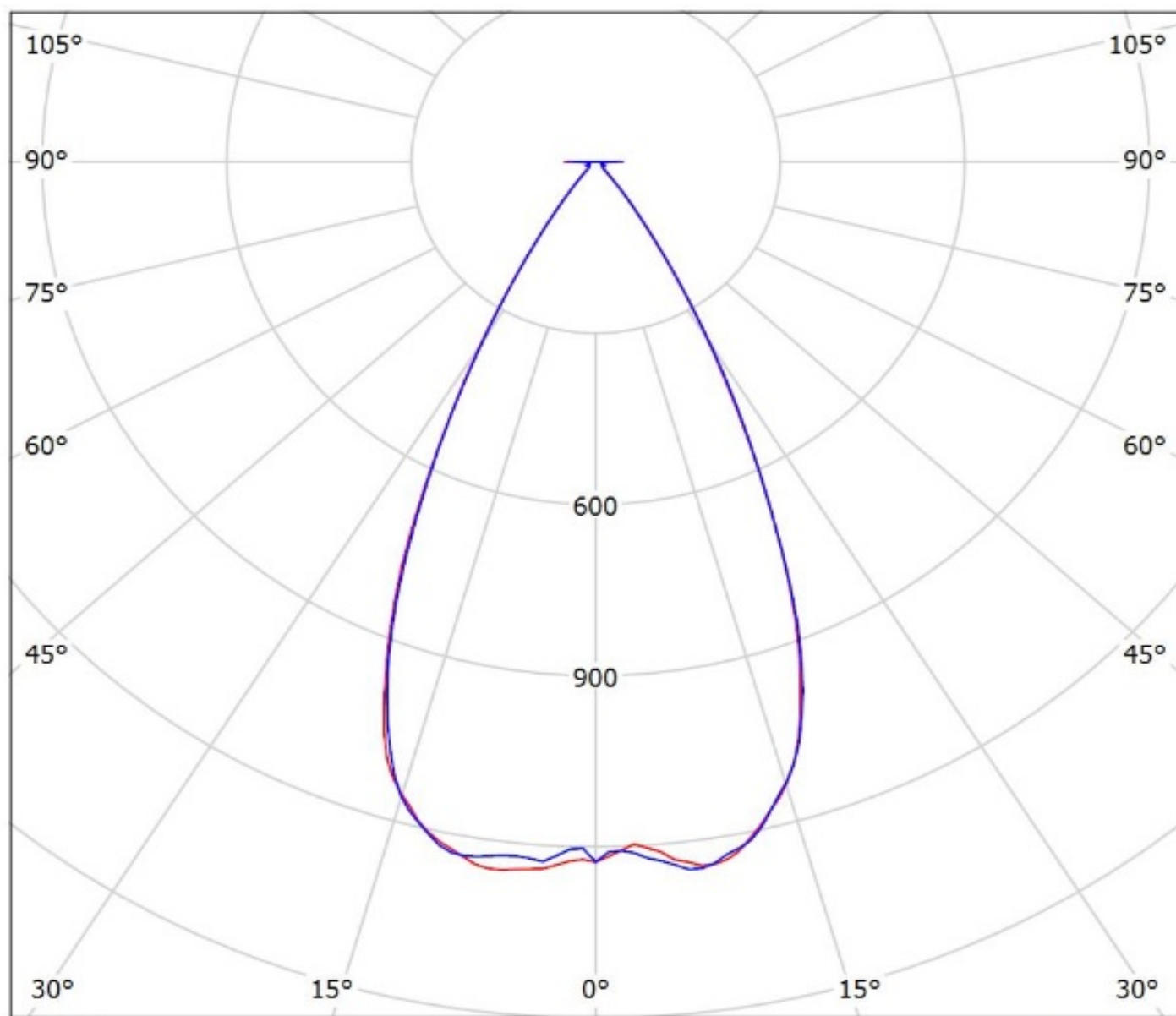

cd/klm
— C0 - C180 — C90 - C270

$\eta = 95\%$

Luminaire: Ledil C14605_HB-2X2-RW_(LH351B)

Lamps: 1 x Samsung_LH351B_2x2_444.178lm@250mA_P=2.8535W_I=0.25A

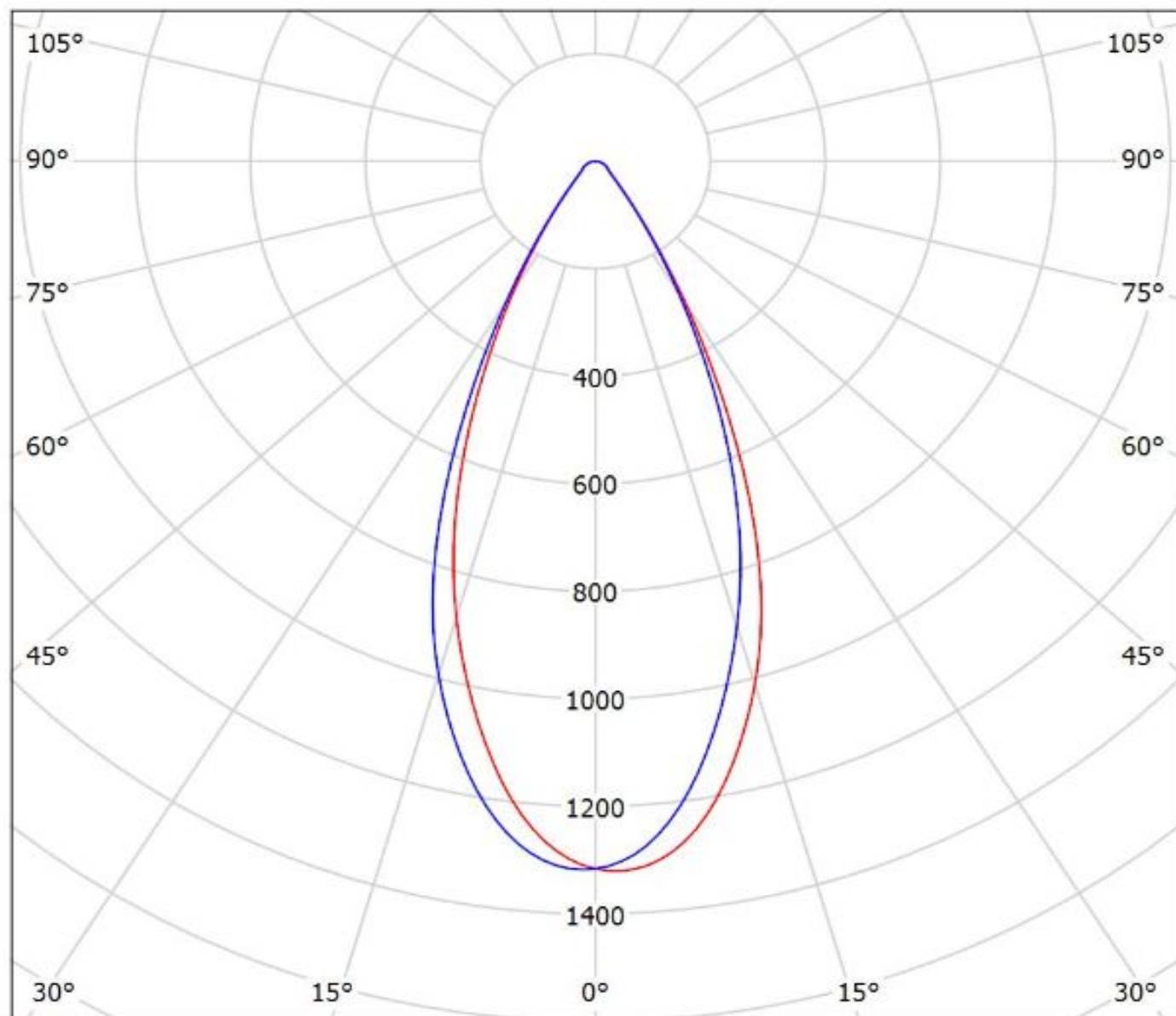

cd/klm

— C0 - C180

— C90 - C270

$\eta = 86\%$

Luminaire: Ledil C14605_HB-2X2-RW_(LH351D)

Lamps: 1 x Samsung_LH351D_536.957lm@250mA_P=2.7695W_I=0.250A

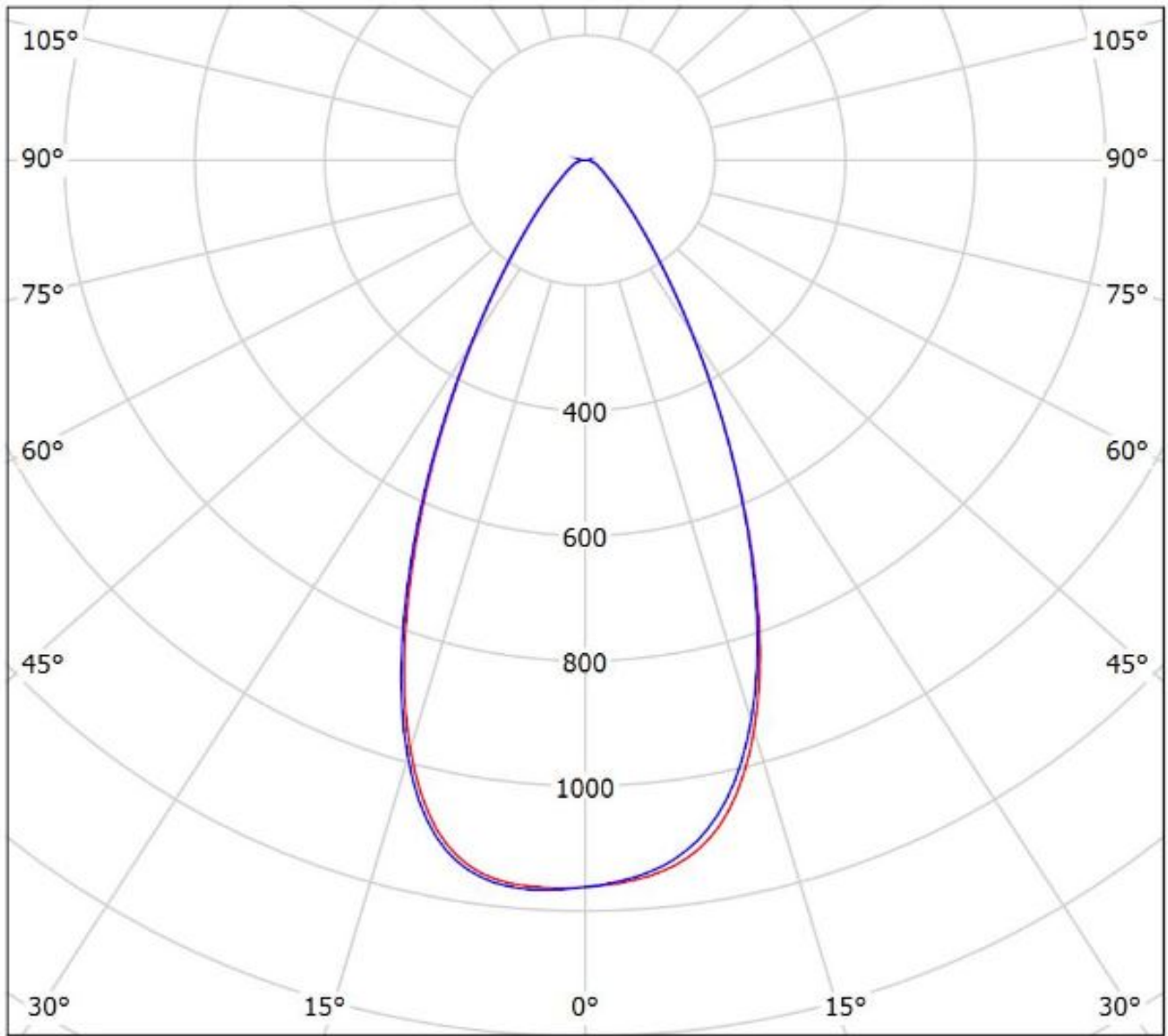

cd/klm

— C0 - C180

— C90 - C270

$\eta = 94\%$

Luminaire: Ledil C14605_HB-2X2-RW_(LH508A)

Lamps: 1 x Samsung_LH508A_2x2_2060.04lm@160mA_CCT=5000K_CRI=80_P=15.5405W_I=0.16A

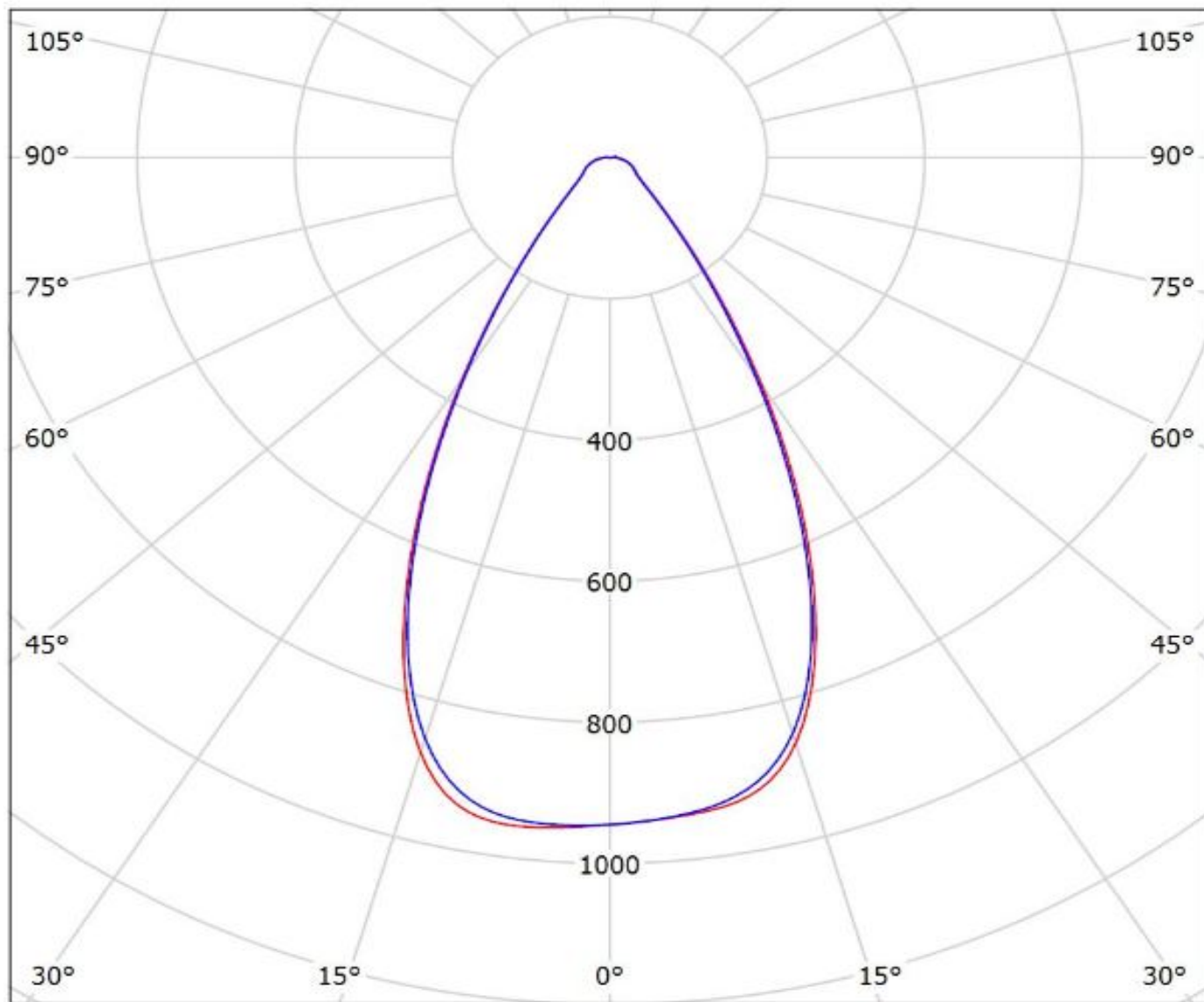

cd/klm

— C0 - C180 — C90 - C270

$\eta = 93\%$

Luminaire: Ledil C14605_HB-2X2-RW_(Z8Y22plus)

Lamps: 1 x Seoul_Z8Y22plus_(W6E2G)_513.996lm@250mA_P=2.754W_I=0.250A

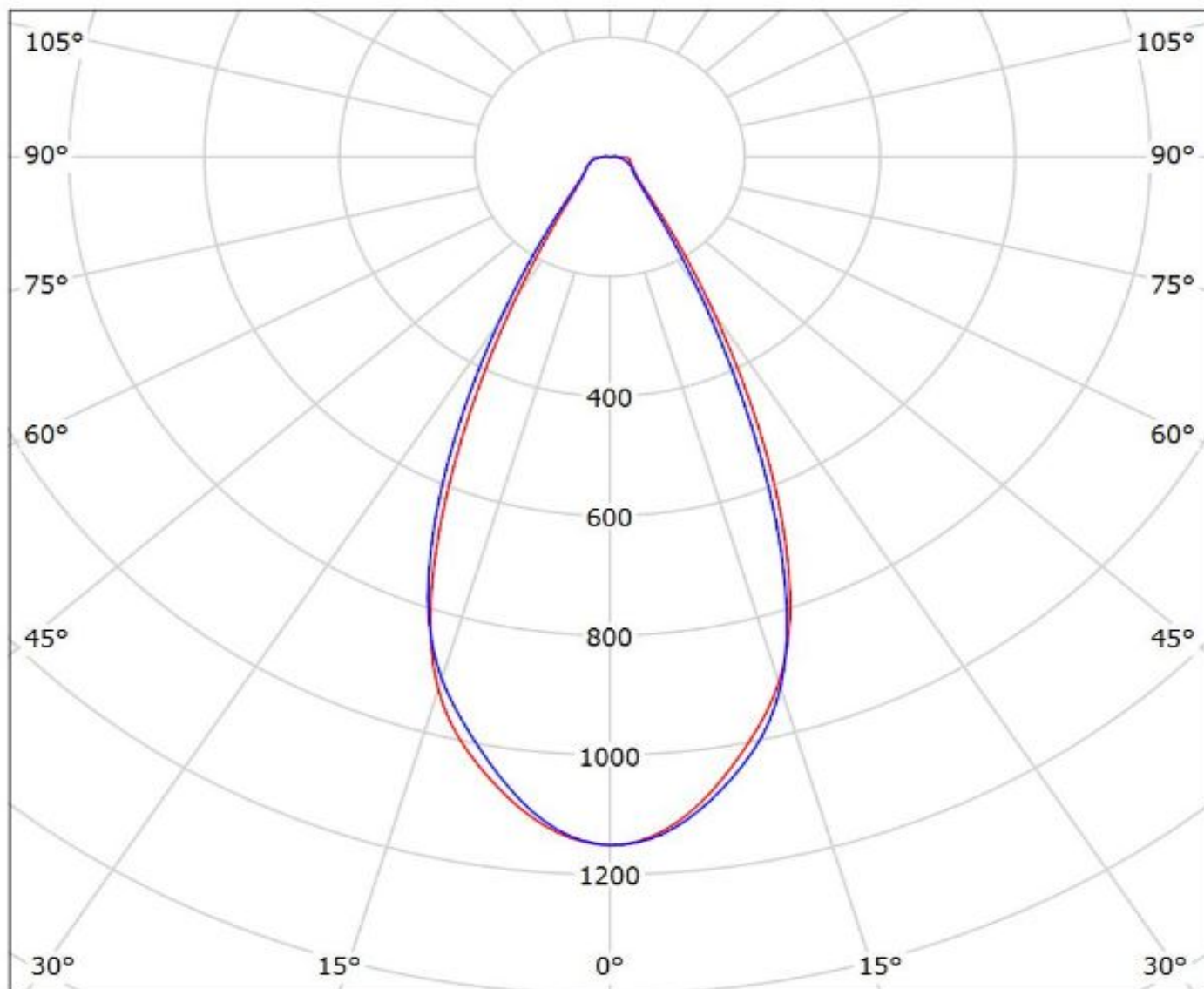

cd/klm

— C0 - C180 — C90 - C270

$\eta = 92\%$

Luminaire: LEDiL Oy C14605_HB-2X2-RW_(Tridonic_Module_RLE_G1) Tridonic_Module_RLE_G1_4576.03lm@700mA_P=32.0681W_I=0.700A
Lamps: 1 x Tridonic_Module_RLE_G1_4576.03lm@700mA_P=32.0681W_I=0.700A

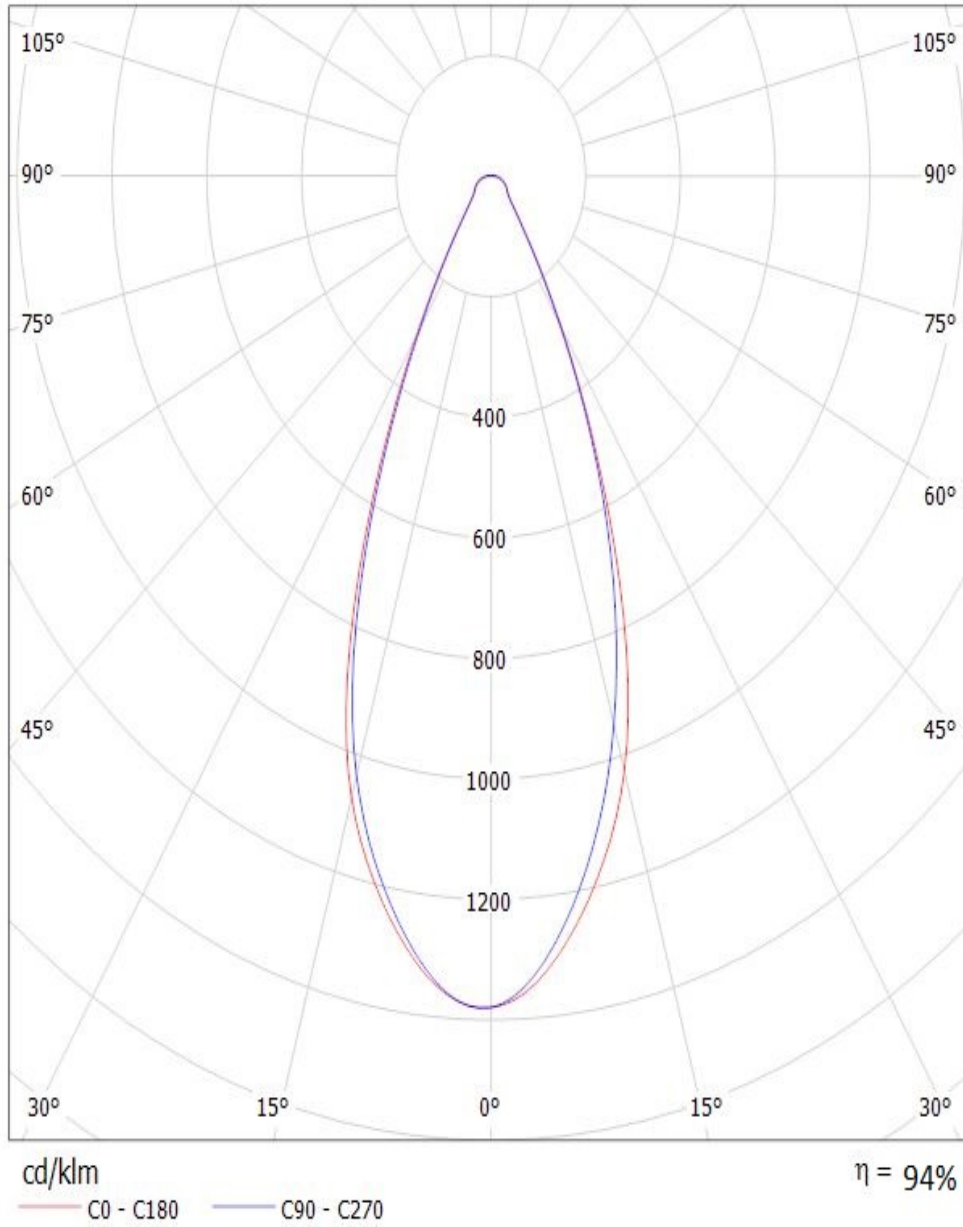

Luminaire: LEDiL Oy C14605_HB-2X2-RW_(Tridonic_Module_RLE_G1) Tridonic_Module_RLE_G1_4576.03lm@700mA_P=32.0681W_I=0.700A
Lamps: 1 x Tridonic_Module_RLE_G1_4576.03lm@700mA_P=32.0681W_I=0.700A

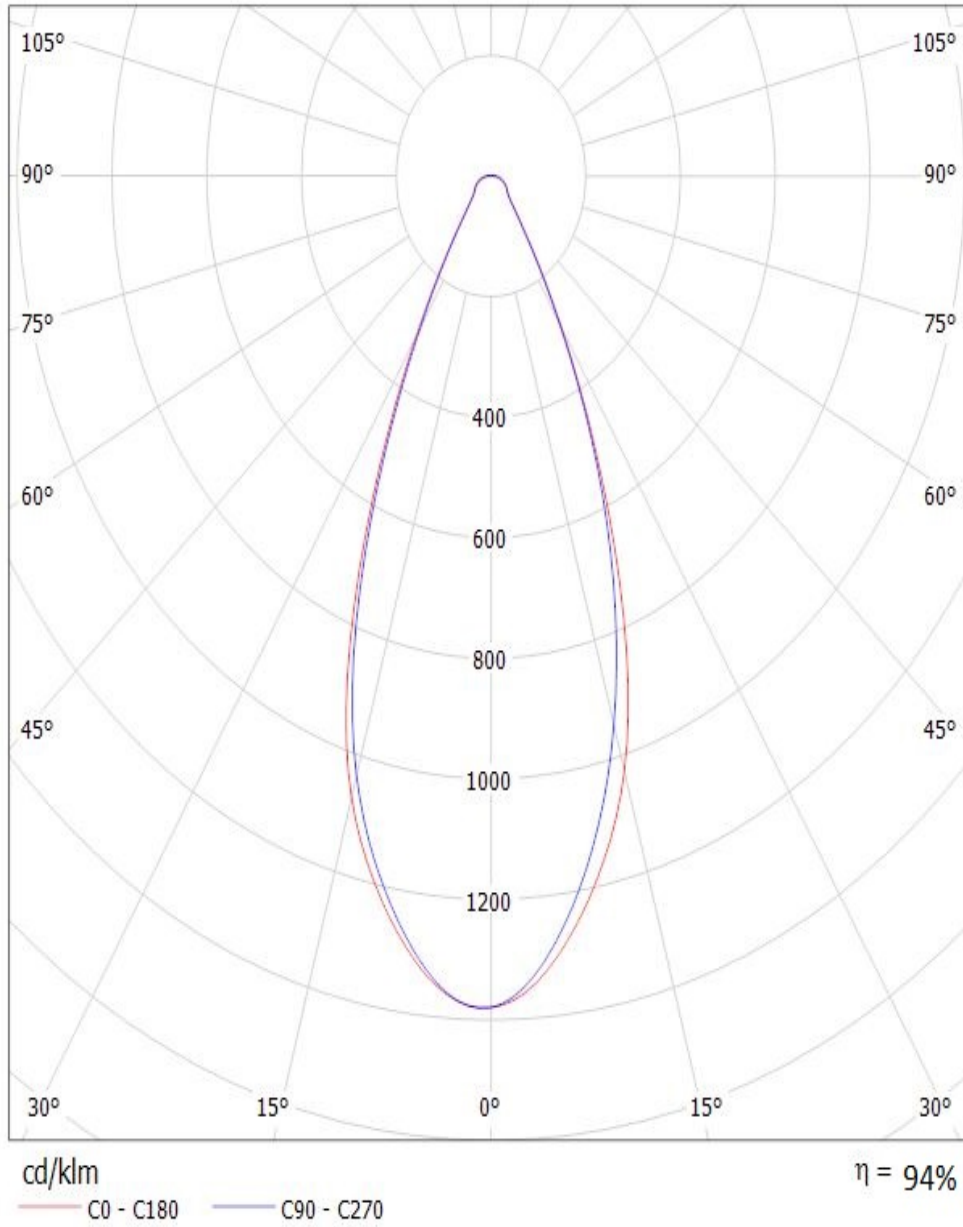

Luminaire: LEDiL Oy C14605_HB-2X2-RW_(Tridonic_Module_RLE_G1)
Lamps: 1 x Tridonic_Module_RLE_G1_2288lm@700mA_P=16W_I=0.700A

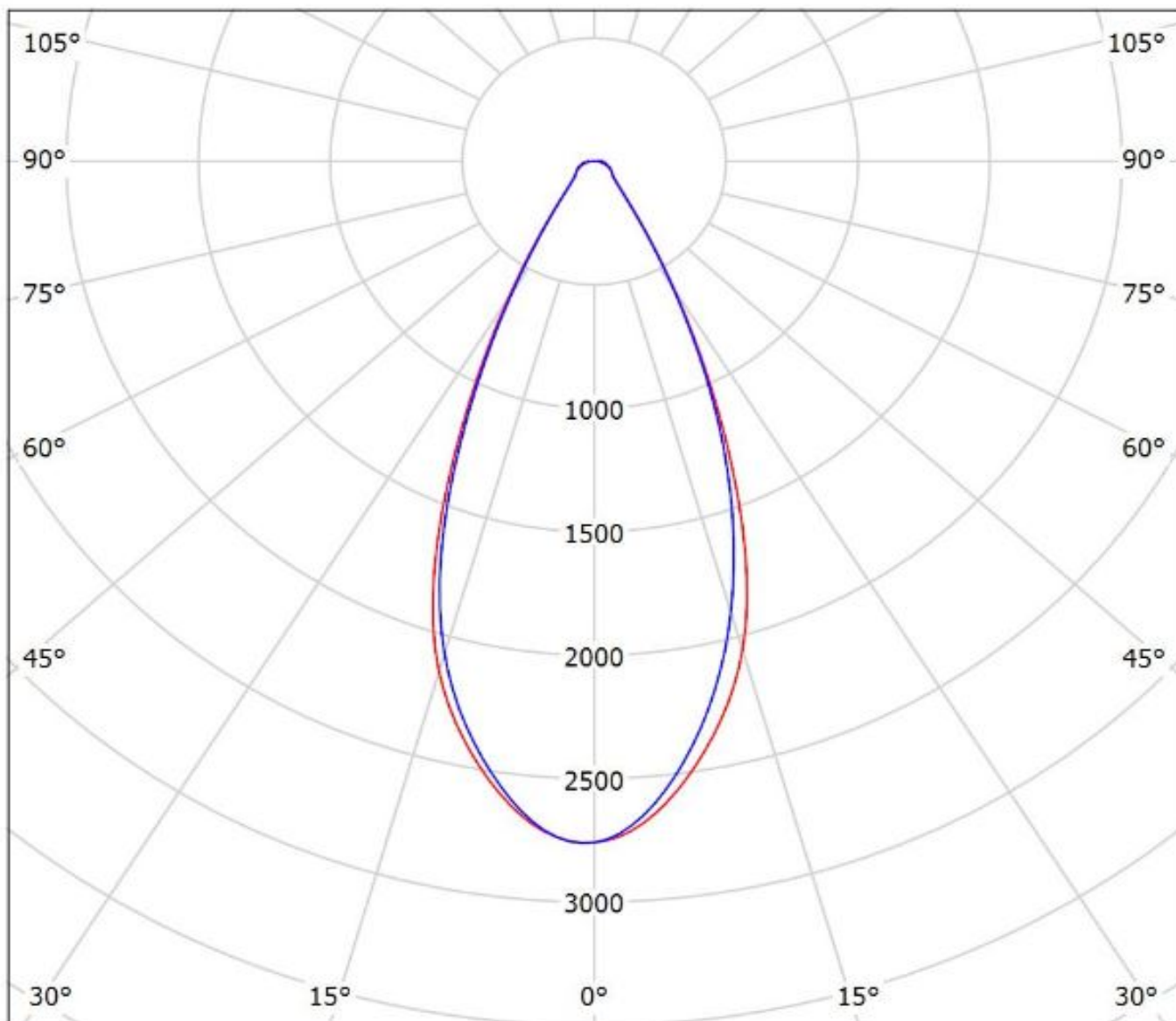

cd/klm
— C0 - C180 — C90 - C270

$\eta = 191\%$

Luminaire: LEDiL Oy C14605_HB-2X2-RW_(Tridonic_Module_RLE_G1)
Lamps: 1 x Tridonic_Module_RLE_G1_2288lm@700mA_P=16W_I=0.700A

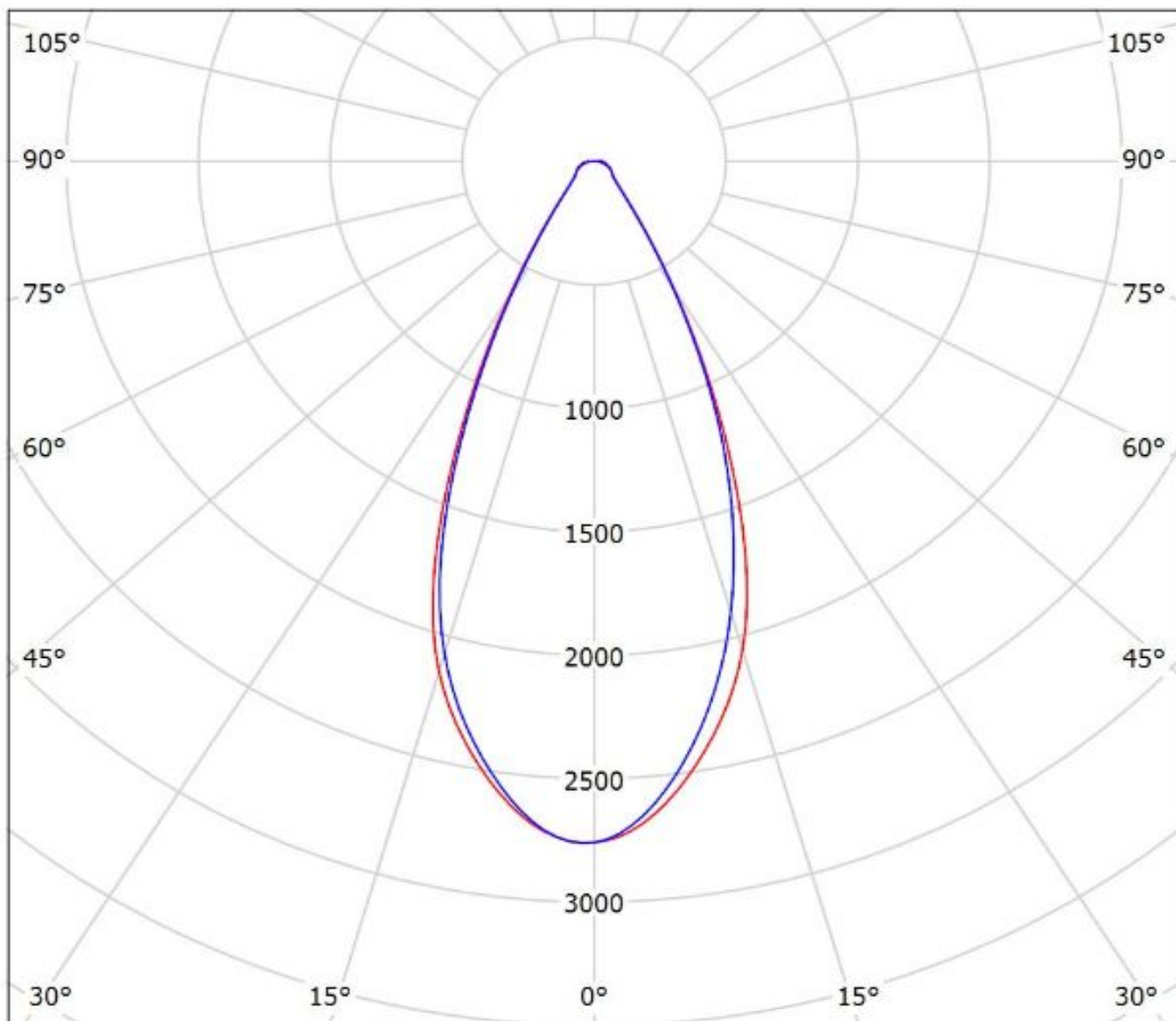

cd/klm
— C0 - C180 — C90 - C270

$\eta = 191\%$

NOTE: The typical divergence will be changed by different color, chip size and chip position tolerance. The typical total divergence is the full angle measured where the luminous intensity is half of the peak value.