

GPS Active Antenna JCA601

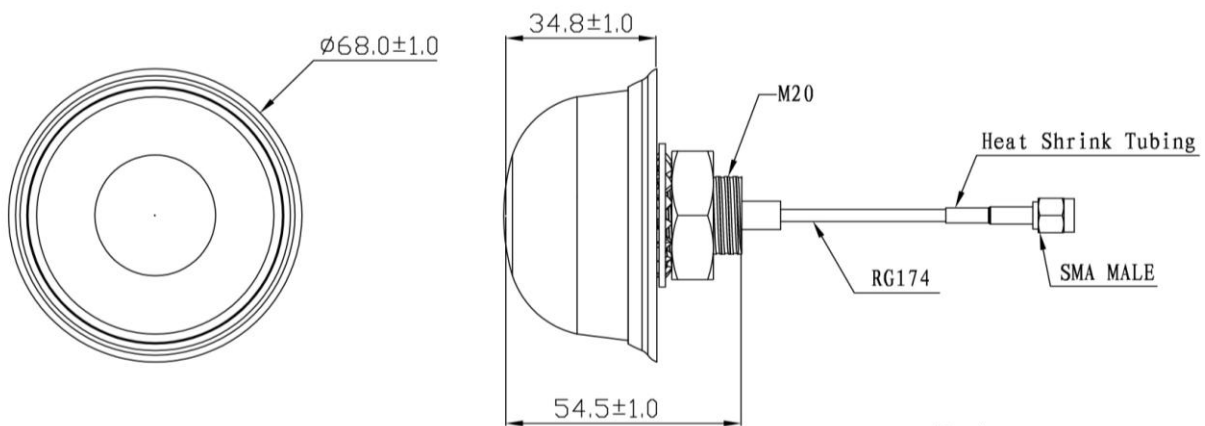

DIMENSIONS



Unit: mm

SPECIFICATIONS

Item	Specifications	
Antenna	Center Frequency	1575.42 ± 3MHz
	Band Width	CF ± 5MHz
	Polarization	RHCP
	Gain	2dBic (Zenith)
	V.S.W.R	< 1.5
	Impedance	50Ω
	Axial Ratio	3dB (max)
	Dimension	25*25*4mm
LNA	Gain	28 ± 2dB
	Noise Figure	< 2.0dB
	Supply Voltage	2.2~5V DC
	Current Consumption	< 20mA
	V.S.W.R	< 2.0
Mechanical	Cable	RG174 or others
	Connector	SMA/MCX/FAKRA or others
	Radome Material	ABS
	Mounting Method	Screw
Environmental	Operating Temperature	-40°C ~ +85°C
	Relative Humidity	Up to 95%
	Ingress Protection	IP67 (exclude cable outlet)
	Vibration	10 to 55Hz with 1.5mm amplitude 2hours
	Environmentally Friendly	ROHS Compliant

Radiation Pattern

