

FIGARO

an ISO9001/14001 company

Technical Information on Usage of TGS Sensors for Toxic and Explosive Gas Leak Detectors

Figaro TGS sensors are a type of thick film metal oxide semiconductor which offer low cost, long life, and good sensitivity to target gases while utilizing a simple electrical circuit. These sensors are especially suited to application in gas leak detectors for toxic and explosive gases.



	<i>Page</i>
<i>Operation Principle</i>	2
<i>Sensor Characteristics</i>	
Dependency on Partial Pressure of Oxygen.....	3
Sensitivity to Gas.....	3
Sensor Response.....	3
Initial Action.....	4
Temperature and Humidity Dependency.....	4
Long Term Stability.....	4
Heater Voltage Dependency	4
<i>Cautions on Usage of Sensors</i>	5
<i>Circuit</i>	
Load Resistor (RL).....	6
Signal Processing.....	6
Temperature Compensation Circuit.....	7
Inrush Current of Heater.....	8
Sensor Heater Breakage Detection Circuit.....	8
Preventing Initial Action from Activating an Alarm.....	8
Buzzer Delay Circuit.....	8
<i>Detector Design</i>	
Circuit.....	9
Detector Casing.....	9
Prototype Evaluation Test.....	9
<i>Manufacturing Detectors</i>	
Production Facilities	
Preheating facility for sensors/detectors.....	10
Gas chamber.....	10
Factory environment.....	10
Manufacturing Process	
Storage of sensor.....	10
Sensor preheating.....	10
PCB assembly.....	10
Sensor assembly.....	10
PCB preheating.....	10
Calibration.....	11
Final assembly.....	11
Preheating final assembly.....	11
Gas test.....	11
Recalibration.....	11
Storage of finished product.....	11
<i>Quality Control</i>	11

1. Operation Principle

The sensing material in TGS gas sensors is metal oxide, most typically SnO₂. When a metal oxide crystal such as SnO₂ is heated at a certain high temperature in air, oxygen is adsorbed on the crystal surface with a negative charge. Then donor electrons in the crystal surface are transferred to the adsorbed oxygen, resulting in leaving positive charges in a space charge layer. Thus, surface potential is formed to serve as a potential barrier against electron flow (Figure 1).

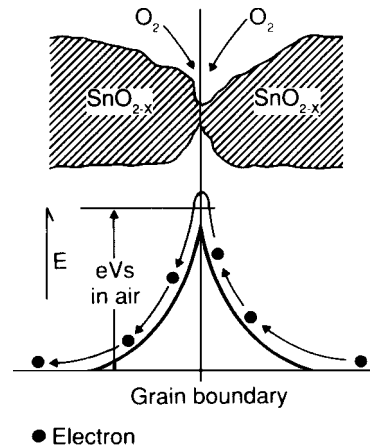

Fig. 1 - Model of inter-grain potential barrier (in the absence of gases)

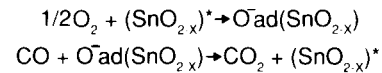

Fig. 2 - Scheme of the reaction between CO and adsorbed oxygen on SnO₂

Inside the sensor, electric current flows through the conjunction parts (grain boundary) of SnO₂ micro crystals. At grain boundaries, adsorbed oxygen forms a potential barrier which prevents carriers from moving freely. The electrical resistance of the sensor is attributed to this potential barrier. In the presence of a deoxidizing gas, the surface density of the negatively charged oxygen decreases, so the barrier height in the grain boundary is reduced (Figures 2 and 3). The reduced barrier height decreases sensor resistance.

The relationship between sensor resistance and the concentration of deoxidizing gas can be expressed by the following equation over a certain range of gas concentration:

$$R_s = A[C]^{-\alpha}$$

where: R_s = electrical resistance of the sensor

A = constant

$[C]$ = gas concentration

α = slope of R_s curve

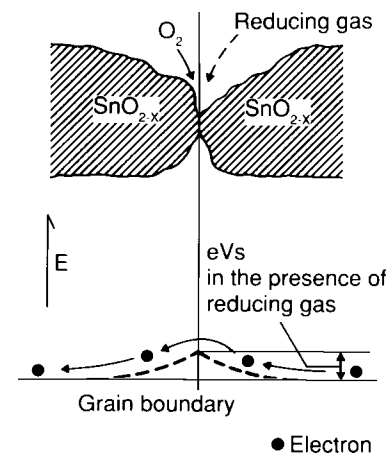

Fig. 3 - Model of inter-grain potential barrier (in the presence of gases)

2. Sensor Characteristics

2-1 Dependency on partial pressure of oxygen

Figure 4 illustrates the relationship between oxygen pressure in the atmosphere (PO_2) and the resistance of a typical TGS sensor in clean air. Note that reduced oxygen pressure will decrease the sensor's resistance.

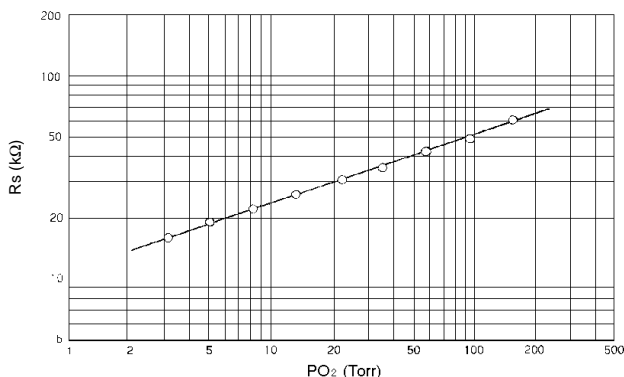

Fig. 4 - Typical dependency on PO_2

2-2 Sensitivity to gas

According to the formula in Section 1, the relationship of sensor resistance to gas concentration is linear on a logarithmic scale within a practical range of gas concentration (from several ppm to several thousand ppm). Figure 5 shows a typical example of the relationship between sensor resistance and gas concentration. The sensor will show sensitivity to a variety of deoxidizing gases, with relative sensitivity to certain gases optimized by the formulation of sensing materials and operating temperature. Since actual sensor resistance values vary from sensor to sensor, typical sensitivity characteristics are expressed as a ratio of sensor resistance in various concentrations of gases (R_s) over resistance in a certain concentration of a target gas (R_o).

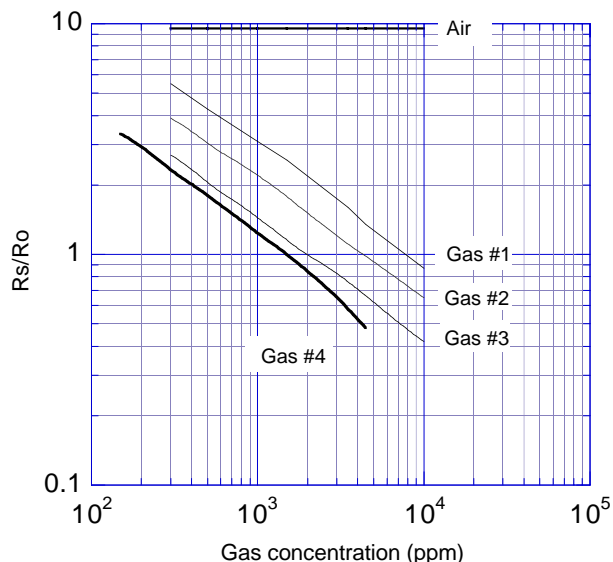

Fig. 5 - Typical sensitivity characteristics

2-3 Sensor response

Figure 6 demonstrates typical behavior when the sensor is exposed to and then removed from a deoxidizing gas. Sensor resistance will drop very quickly when exposed to gas, and when removed from gas its resistance will recover to its original value after a short time. The speed of response and reversibility will vary according to the model of sensor and the gas involved.

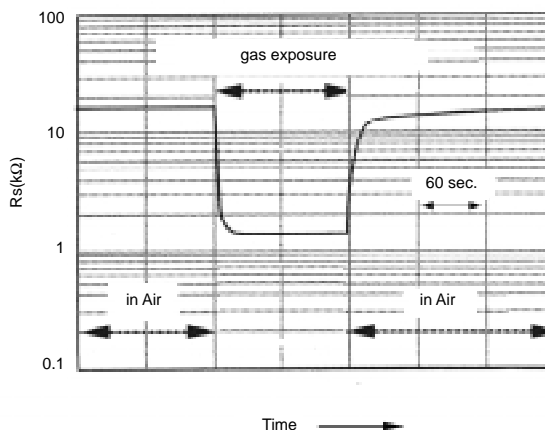

Fig. 6 - Typical sensor response

2-4 Initial action

As shown in Figure 7, all sensors exhibit a transient behavior referred to as “Initial Action” when stored unenergized and later energized in air. The R_s drops sharply for the first few seconds after energizing, regardless of the presence of gases, and then reaches a stable level according to the ambient atmosphere. The length of initial action depends on the atmospheric conditions during storage and length of storage and varies by sensor model. This behavior should be considered when designing a circuit since it may cause activation of an alarm during the first few moments of powering (refer to Section 4-6).

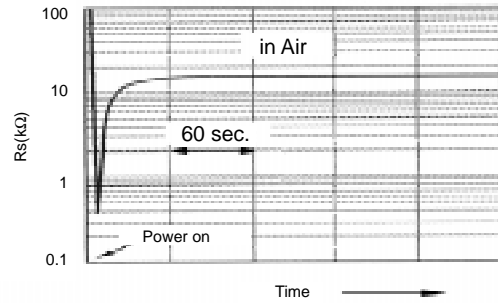

Fig. 7 - Typical initial action

2-5 Dependency on temperature and humidity

The detection principle of TGS sensors is based on chemical adsorption and desorption of gases on the sensor’s surface. As a result, ambient temperature will affect sensitivity characteristics by changing the rate of chemical reaction. In addition, humidity causes a decrease in R_s as water vapor adsorbs on the sensor’s surface. Figure 8 shows a typical example of these dependencies. A compensation circuit for temperature dependency should be considered when using TGS sensors (refer to Section 4-3).

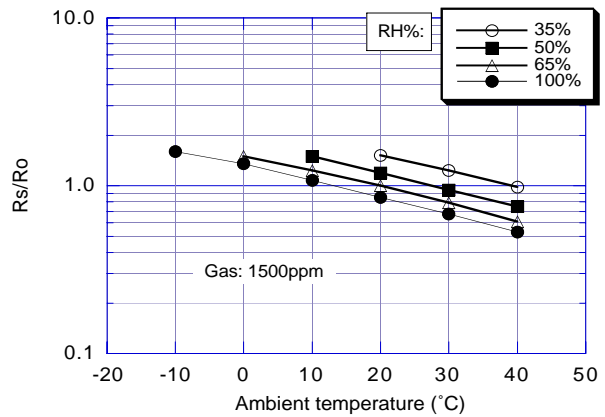

Fig. 8 - Typical temperature and humidity dependency

2-6 Long term stability

Figure 9 shows typical data of long term stability for TGS series sensors. Generally, TGS sensors show stable characteristics over time, making them suitable for maintenance-free operation.

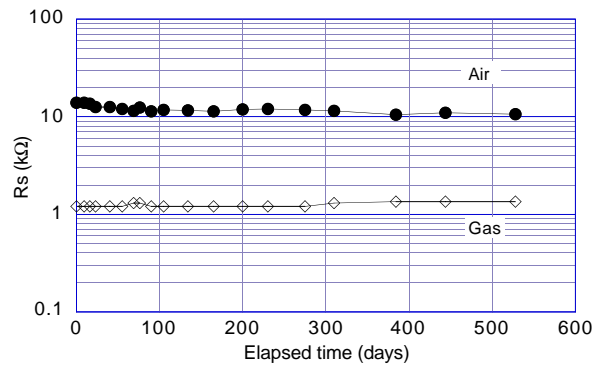

Fig. 9 - Typical long term stability

2-7 Heater voltage dependency

TGS sensors are designed to show optimum sensitivity characteristics under a certain constant heater voltage. Figure 10 shows a typical example of how gas sensitivity varies depending on heater voltage. Since the sensor has a heater voltage dependency, a constant regulated heater voltage must be supplied to the sensor according to specifications.

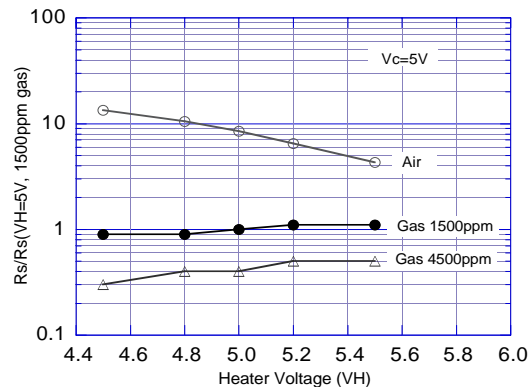

Fig. 10 - Typical heater voltage dependency

3 Cautions on Usage of Figaro Gas Sensors

3-1 Situations which must be avoided

1) Exposure to silicone vapors

If silicone vapors adsorb onto the sensor's surface, the sensing material will be coated, irreversibly inhibiting sensitivity. Avoid exposure where silicone adhesives, hair grooming materials, or silicone rubber/putty may be present.

2) Highly corrosive environment

High density exposure to corrosive materials such as H₂S, SO_x, Cl₂, HCl, etc. for extended periods may cause corrosion or breakage of the lead wires or heater material.

3) Contamination by alkaline metals

Sensor drift may occur when the sensor is contaminated by alkaline metals, especially salt water spray.

4) Contact with water

Sensor drift may occur due to soaking or splashing the sensor with water.

5) Freezing

If water freezes on the sensing surface, the sensing material would crack, altering characteristics.

6) Application of excessive voltage

If higher than specified voltage is applied to the sensor or the heater, lead wires and/or the heater may be damaged or sensor characteristics may drift, even if no physical damage or breakage occurs.

7) Application of voltage on lead wires (8-series only)

On six-pin type sensors, if a voltage is applied on the lead wires between pins 1 and 3 and/or pins 4 and 6, this would cause breakage of the lead wires.

8) Operation in zero/low oxygen environment

TGS sensors require the presence of around 21%

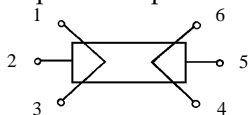

(ambient) oxygen in their operating environment in order to function properly and to exhibit characteristics described in Figaro's product literature. TGS sensors cannot properly operate in a zero or low oxygen content atmosphere.

3-2 Situations to be avoided whenever possible

1) Water condensation

Light condensation under conditions of indoor usage

should not pose a problem for sensor performance. However, if water condenses on the sensor's surface and remains for an extended period, sensor characteristics may drift.

2) Usage in high density of gas

Sensor performance may be affected if exposed to a high density of gas for a long period of time, regardless of the powering condition.

3) Storage for extended periods

When stored without powering for a long period, the sensor may show a reversible drift in resistance according to the environment in which it was stored. The sensor should be stored in a sealed bag containing clean air; do not use silica gel. *Note that as unpowered storage becomes longer, a longer preheating period is required to stabilize the sensor before usage.*

4) Long term exposure in adverse environment

Regardless of powering condition, if the sensor is exposed in extreme conditions such as very high humidity, extreme temperatures, or high contamination levels for a long period of time, sensor performance will be adversely affected.

5) Vibration

Excessive vibration may cause the sensor or lead wires to resonate and break. Usage of compressed air drivers/ultrasonic welders on assembly lines may generate such vibration, so please check this matter.

6) Shock

Breakage of lead wires may occur if the sensor is subjected to a strong shock.

7) Soldering

Ideally, sensors should be soldered manually. However, wave soldering can be done under the following conditions:

a) Suggested flux: rosin flux with minimal chlorine

b) Speed: 1-2 meters/min.

c) Preheating temperature: 100±20°C

d) Solder temperature: 250±10°C

e) Up to two passes through wave soldering machine allowed

Results of wave soldering cannot be guaranteed if conducted outside the above guidelines since some flux vapors may cause drift in sensor performance similar to the effects of silicone vapors (*please refer to Sec. 6-2.3/4*). For soldering conditions of 8-series gas sensors, refer to *Technical Advisory for Soldering 8-type Gas Sensors*.

4. Circuit Design

4-1 Load resistor (RL)

Signal output is obtained through the RL which also acts as a sensor protector by regulating sensor power consumption (P_s) below the rated value for the sensor. Proper selection of the RL for an individual sensor enables the sensor to provide uniform characteristics so that users can apply the sensor under the best characteristics.

Figure 11 shows typical sensitivity characteristics of a sensor. Figure 12 shows gas concentration vs. output voltage (V_{RL}) when the sensor is used in a circuit (such as that shown in Figure 14) along with various RL values (5k Ω , 2.5k Ω , 1k Ω).

Figure 13 shows the relationship between R_s/RL and V_{RL}/V_c . At the point where R_s/RL equals 1.0, the slope of V_{RL}/V_c reaches its maximum. At this point, the optimal resolution of signal at alarm concentration can be obtained. As a result, it is recommended to use an RL whose R_s/RL value is equal to 1.0 at the concentration to be detected. A variable resistor (RL) is recommended for optimal results.

4-2 Signal processing

The conventional method to process signal output is to use a comparator as shown in Figure 14. When the V_{RL} exceeds a preset value (V_{ref}), the comparator signal activates external equipment such as a buzzer or LED lamp.

Usage of a microprocessor is becoming more popular for signal processing. Microprocessors are commonly used and inexpensive, and they can perform the same function as a comparator in addition to other useful functions such as temperature dependency compensation, auto-calibration, etc.

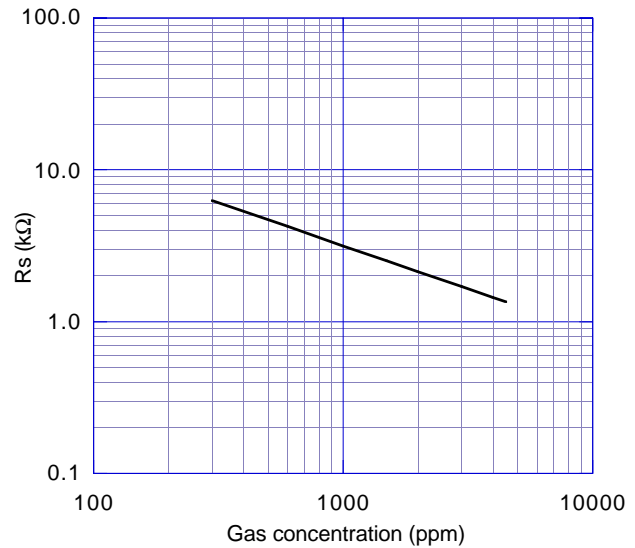

Fig. 11 - Sensitivity characteristics (R_s)

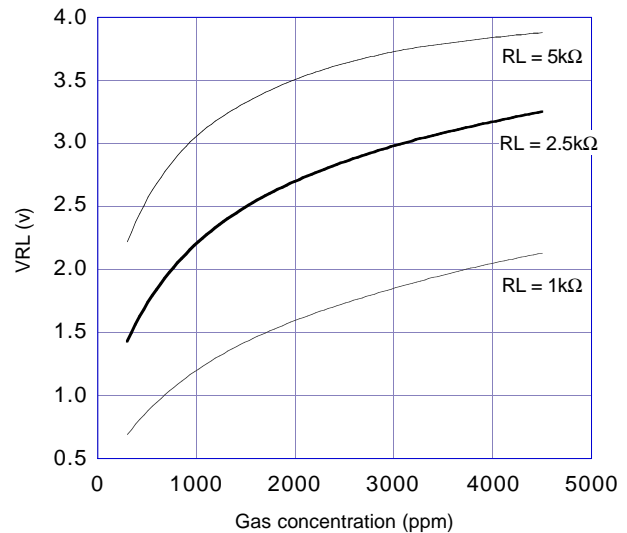

Fig. 12 - Sensitivity characteristics (V_{RL})

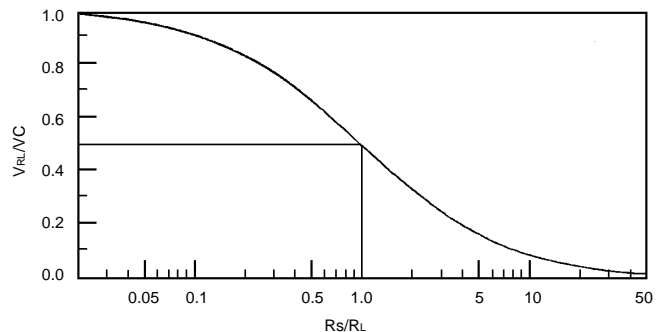

Fig. 13 - Relationship between R_s/RL and V_{RL}/V_c

4-3 Temperature compensation circuit

Figure 15 shows a typical sensitivity curve for a target gas under several ambient conditions. Without a compensation circuit, the alarm point could vary from 600ppm to 3400ppm when calibrated at 1500ppm of target gas in conditions of 20°C / 65%RH.

Assuming a constant average RH of 65%, the Vref in Figure 14 can be changed by using a thermistor in order to compensate for this dependency to a certain degree. For example, Vref may be changed from 2.5v to 3.1v (under 40°C and 65%RH) or to 1.9v (under -10°C). The results of using a compensation circuit are illustrated in Figure 16 and Table 1.

Measuring Condition		Gas Concentration (ppm)	
Temp. (°C)	Humidity (%RH)	with Comp. Circuit	w/o Comp. Circuit
-10	65	1400	3400
0	65	1450	3100
10	65	1475	2500
20	65	1500	1500
30	65	1505	1000
40	65	1520	600

Table 1 - Effect of compensation circuit

To select a thermistor and additional resistors, the following method is suggested:

- 1) Identify the range of ambient temperature and humidity expected in the application. Extremes of -10°C and 40°C / 40%~65%RH could be considered, with an average value of 20°C and 65%RH.
- 2) Obtain sensitivity characteristic curves to the target gas at the above range of ambient conditions.
- 3) Decide the thermistor and the additional resistor to approximate the average curve.

Recommended values for a compensation circuit such as that shown in Figure 14 are shown below:

Th : $R_s(25^\circ\text{C}) = 8\text{k}\Omega$ B = 4200
 $R_1 = 1\text{k}\Omega$ $R_2 = 10\text{k}\Omega$
 $R_3 = 0.8\text{k}\Omega$ $R_4 = 5.8\text{k}\Omega$
 $R_5 = 10\text{k}\Omega$ $V_R = 10\text{k}\Omega$

Note: Compensation of humidity dependency under a constant temperature cannot be achieved using this method.

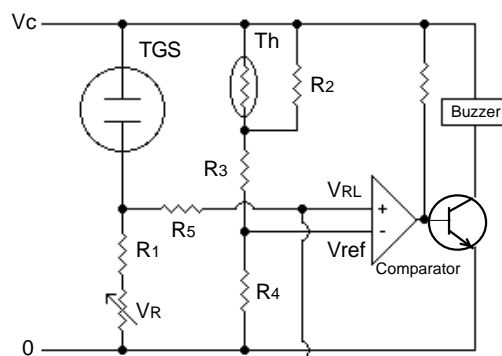

$R_L = R_1 + R(V_R)$

Fig. 14 - Conventional circuit for temperature compensation

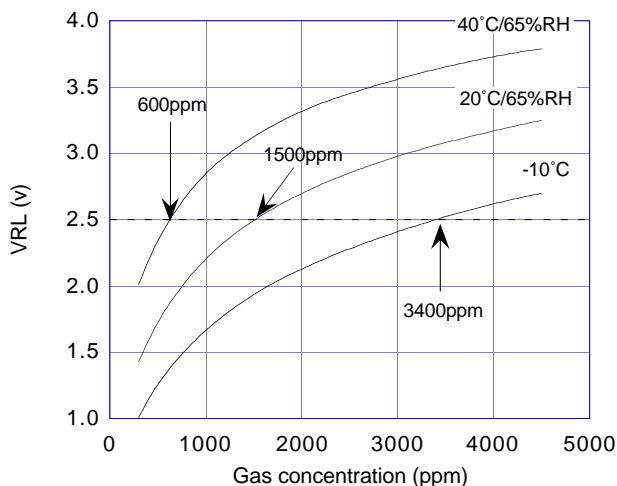

Fig. 15 - Alarm point under several ambient conditions

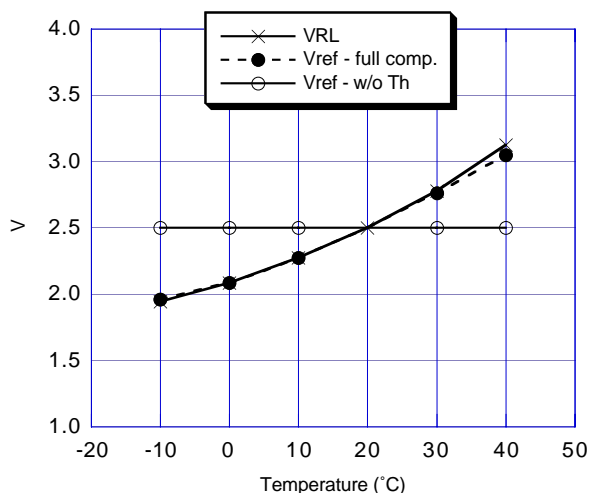

Fig. 16 - Effect of compensation circuit

4-4 Inrush current of heater of TGS2000 series

The heater material of the sensor has its own temperature dependency. Figure 17 shows both the inrush current and steady state of heater current under various ambient temperatures for the TGS2000 series. This chart illustrates that inrush current is approximately 50% higher than the steady state current. Since heater resistance shows a lower value at low temperatures, this would cause a larger than expected current at room temperature. As a result, when a device using the sensor is first powered on, an extremely high current may be generated during the first few moments of energizing. To ensure sufficient power supply capacity for inrush current, maximum inrush current should be taken into consideration when designing the power supply circuit and when choosing components for the power supply.

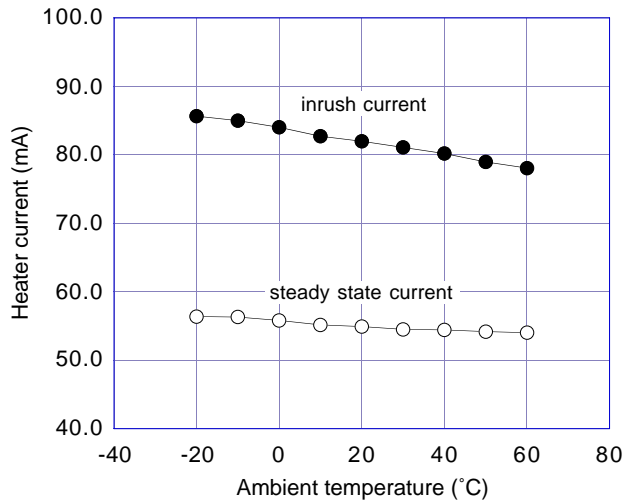

Fig. 17 - Ambient temperature dependency of heater current for TGS2000 series sensors

4-5 Sensor heater breakage detection circuit

Breakage of the sensor's heater can be detected by a resistor connected to the heater in series. The voltage across the connected resistor can be used for this purpose.

4-6 Preventing initial action from activating an alarm

As described in Section 2-4, R_s drops sharply for the first few seconds after energizing, causing V_{RL} to exceed V_{ref} , regardless of the presence of gases, and then moves towards a stable level according to the ambient atmosphere (*initial action*). Since this behavior during the warm-up process would be likely to activate an alarm during the first few moments of energizing, to prevent initial action from activating an alarm, a circuit such as that shown in Figure 18 should be used. This circuit should be connected to V_{RL} in the sensor circuit (see Fig. 14).

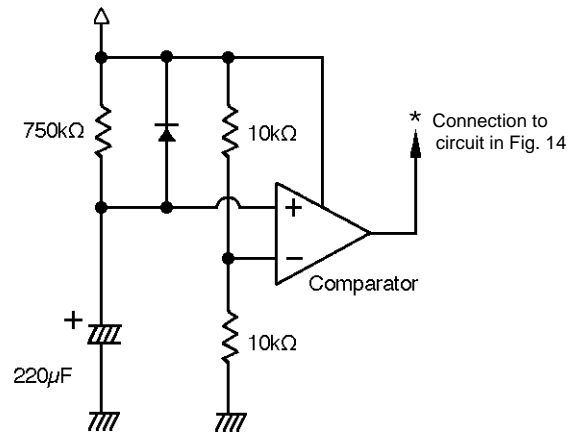

Fig. 18 - Prevention of alarm activation due to initial action

4-7 Buzzer delay circuit

To prevent false alarm caused by transient interference gases such as alcohol in cooking vapors, a delay circuit similar to that shown in Figure 18 can be used.

5. Detector Design

(See Figure 19 for sample flowchart)

5-1 Circuit

1) When a thermistor is used to compensate for temperature dependency, note that the thermistor will compensate for temperature variations which may occur around the sensor. Therefore, place the sensor and thermistor in an area where they will not be affected by heat generated by the circuits.

2) Be sure to adhere to the specified sensor heater operating conditions such as voltage, current, heating cycle, and detection timing.

3) When designing circuit configuration (pattern width, distance between circuit paths, and layout), take into consideration the large current which flows through the sensor.

4) The value of the load resistor should be set close to the sensor's resistance value at the alarm setting. When a variable resistor is used, consider its adjustable range.

5) The circuit function should include a fail-safe mode for detection of lead wire or heater breakage and sensor element deterioration.

5-2 Detector casing

1) The case should have a small partition around the sensor (refer to Fig. 19-1). Such a compartment promotes quick sensor response via convection and minimizes influence on the sensor from high temperatures which may be generated by other components in the detector. A sufficient number of wide slits should be made in at least two sides of the detector housing to facilitate gas flow around the sensor (refer to Fig. 19-2).

2) Design the case so that heat dissipation is maximized from the case.

5-3 Prototype evaluation test

Prototype evaluation test should be conducted to see whether or not mass production may be started.

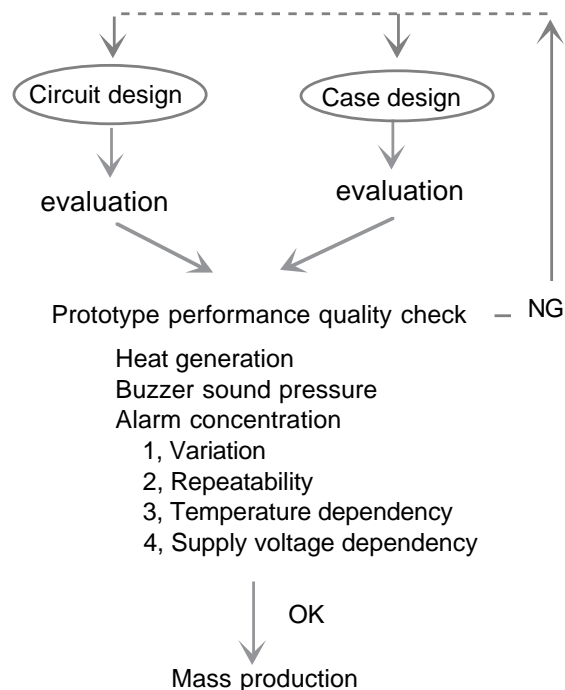

Fig. 19 - Flowchart for design of detectors



Fig. 19-1 - Example of sensor compartment in detector housing



Fig. 19-2 - Example of slits to be located in detector housing for facilitating airflow through sensor compartment

6. Manufacturing of Detectors

6-1 Production facilities

1) Preheating facility for sensors and detectors

The rated voltage at the rated cycle should be applied constantly regardless of fluctuation in supply voltage. The preheating process should be carried out with sensors/detectors fixed upright, the same as their mounting position on a wall.

2) Gas chamber

Avoid using insulation or sealing materials which may give off fumes after curing, such as silicone sealants and solvent-based adhesives. The air and gas mixture should be provided at a measured and controlled temperature and humidity. The capacity should be large enough—one liter or more per one sensor. Gas should be supplied to detectors using a static gas mixture, thus avoiding direct gas flow onto the sensor which would cause a false high reading. The gassing process should be carried out with detectors fixed upright, the same as their mounting position on a wall.

3) Factory environment

The environment should be clean and free from organic vapors such as alcohol. Special attention should be paid to the environment around the preheating facility for sensors/detectors—keep these areas free from influencing gases, especially silicone vapors. If volatile cleaners such as trichloroethylene, freons, or floor sealants are to be used, all products should be removed from the area to be treated and not returned until the area has been thoroughly ventilated.

6-2 Manufacturing process

(sample flowchart of mfg. process shown in Fig. 20)

1) Handling and storage of sensors

Sensors should be stored in a sealed bag containing normal clean air.

2) Sensor preheating

The minimum period for sensor preheating is 2 days, but for best results, 7 days or longer preheating is

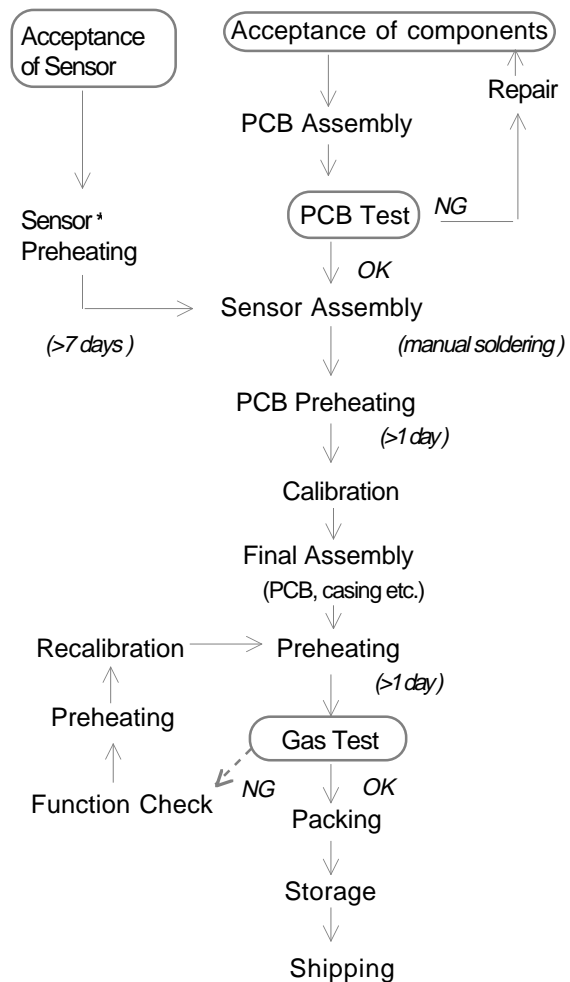

Figure 20 - Flowchart for mfg. detectors

strongly advised. Be sure to adhere to standard circuit conditions and maintain clean atmospheric conditions when preheating.

3) PCB assembly

Flux should be sufficiently dried before sensor assembly onto the PCB is done.

4) Sensor assembly

Manual soldering is strongly advised. Solders composed of Sn63:Pb37 or Sn60:Pb40 with non-chloric resin flux (MIL: RMA Grade; for example, Almit KR-19) are recommended for usage.

5) PCB Preheating

The minimum period for PCB preheating is 2 hours, but for best results 1 day or longer is *strongly*

recommended. Be sure to adhere to standard circuit conditions and maintain clean atmospheric conditions when preheating.

6) Calibration (refer to circuit in Figure 14)

Be certain to calibrate all products using the appropriate target gas concentration(s). Keep the atmospheric conditions in the chamber stable for temperature and humidity. Remove any traces of smoke, adhesives, gases, or solvents from the chamber.

Ex1) When calibrating a detector using a variable load resistor, place the detector in the gas chamber. Prepare the alarm concentration of gas in the test chamber. Adjust the VRL in gas so as to correspond to the V_{ref} .

Ex2) When calibrating a detector using a temporary load resistor (RL^*), place the detector in the test chamber. Prepare the alarm concentration of gas in the chamber. Measure the voltage across the RL^* to obtain R_s at the alarm concentration. Replace the RL^* located inside the detector with an RL that is equal to the R_s measured above.

Note: Be sure that the alarm concentration of gas is humidified to ambient levels. If not, calibration results will be very different from what would be expected under normal usage. Calibration should be done under a user-defined standard test condition which would be determined based on applicable performance standards and anticipated usage conditions for detectors.

7) Final assembly

Avoid any shock or vibration which may be caused by air driven tools.

8) Preheating of final assembly

The minimum period for preheating final assemblies would be 2 hours, but for best results it is *strongly* recommended that 1 day or more preheating be done. Be sure to adhere to standard circuit conditions and maintain clean atmospheric conditions for preheating.

9) Gas test

Test all finished products against the target gas. Keep the atmospheric conditions in the chamber stable, utilizing a user-defined standard test condition which would be determined based on applicable performance standards and anticipated usage conditions for detectors. Remove any traces of smoke, adhesives, gases, or solvents from the chamber.

10) Recalibration after failing gas test

If no problems are noted after circuit function test, recalibration should be conducted. Preheating time should be twice as long as the unenergized period after the gas test for purposes of stabilizing the detector sufficiently. Recalibration should not be repeated more than four times.

11) Storage of finished products

Detectors should be stored in a clean air environment. Avoid storage in dirty or contaminated environments. Cautions listed in *Section 6-1.3* also apply.

7. Quality Control

1) Sample a certain number of finished products from each production lot to confirm alarm concentration. Check whether these samples are acceptable for shipment and maintain a record of these tests.

2) Sample a certain number of finished products periodically to confirm the alarm concentration under extreme conditions (e.g. -10°C or 40°C and 85%RH) and maintain a record of these tests.

3) Sample a certain number of completed products periodically to confirm their long-term characteristics and maintain a record of such test.

Important Reminder

Without calibration and testing after final assembly, detectors have no guarantee of accuracy or reliability.

Figaro USA Inc. and the manufacturer, Figaro Engineering Inc. (together referred to as Figaro) reserve the right to make changes without notice to any products herein to improve reliability, functioning or design. Information contained in this document is believed to be reliable. However, Figaro does not assume any liability arising out of the application or use of any product or circuit described herein; neither does it convey any license under its patent rights, nor the rights of others.

Figaro's products are not authorized for use as critical components in life support applications wherein a failure or malfunction of the products may result in injury or threat to life.

FIGARO GROUP

HEAD OFFICE

Figaro Engineering Inc.
1-5-11 Senba-nishi
Mino, Osaka 562-8505 JAPAN
Tel.: (81) 72-728-2561
Fax: (81) 72-728-0467
email: figaro@figaro.co.jp

OVERSEAS

Figaro USA Inc.
3703 West Lake Ave. Suite 203
Glenview, IL 60026 USA
Tel.: (1) 847-832-1701
Fax.: (1) 847-832-1705
email: figarousa@figarosensor.com